

electronics

JULY · 1951

PRICE 75 CENTS

A MCGRAW-HILL PUBLICATION



TESTING AIRCRAFT FUEL GAGES



Linear Standard Units...

THE ULTIMATE IN QUALITY...

UTC Linear Standard Audio Transformers represent the closest approach to the ideal component from the standpoint of uniform frequency response, low wave form distortion, high efficiency, thorough shielding and utmost dependability.

UTC Linear Standard Transformers feature...

- **True Hum Balancing Coil Structure**... maximum neutralization of stray fields.
- **Balanced Variable Impedance Line**... permits highest fidelity on every tap of a universal unit... no line reflections or transverse coupling.
- **Reversible Mounting**... permits above chassis or sub-chassis wiring.
- **Alloy Shields**... maximum shielding from inductive pickup.
- **Hiperm-Alloy**... a stable, high permeability nickel-iron core material.
- **Semi-Toroidal Multiple Coil Structure**... minimum distributed capacity and leakage reactance.
- **Precision Winding**... accuracy of winding .1%, perfect balance of inductance and capacity; exact impedance reflection.
- **High Fidelity**... UTC Linear Standard Transformers are the only audio units with a guaranteed uniform response of ± 1 DB from 20-20,000 cycles.

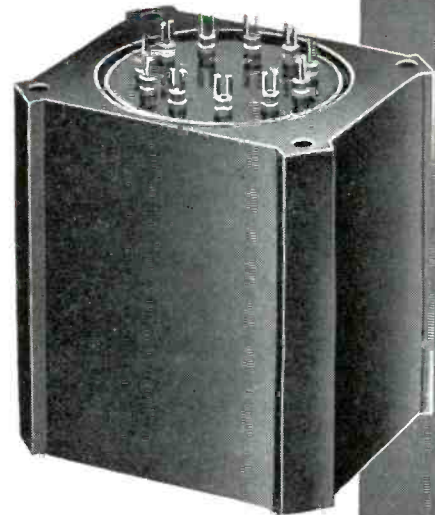

TYPICAL LS LOW LEVEL TRANSFORMERS

Type No.	Application	Primary Impedance	Secondary Impedance	± 1 db from	Max. Level	Relative hum-pickup reduction	Max. Unbalanced DC in primary	List Price
LS-10	Low impedance mike pickup, or multiple line to grid	50, 125, 200, 250, 333, 500/600 ohms	60,000 ohms in two sections	20-20,000	+15 DB	-74 DB	5 MA	\$25.00
LS-10X	As Above	As above	50,000 ohms	20-20,000	+14 DB	-92 DB	5 MA	32.00
LS-12	Low impedance mike pickup, or multiple line to push pull grids	50, 125, 200, 250, 333, 500/600 ohms	120,000 ohms overall, in two sections	20-20,000	+15 DB	-74 DB	5 MA	28.00
LS-12X	As above	As above	80,000 ohms overall, in two sections	20-20,000	+14 DB	-92 DB	5 MA	35.00
LS-26	Bridging line to single or push pull grids	5,000 ohms	60,000 ohms in two sections	15-20,000	+20 DB	-74 DB	0 MA	25.00
LS-19	Single plate to push pull grids like 2A3, 6L6, 300A. Split secondary	15,000 ohms	95,000 ohms; 1.25:1 each side	20-20,000	+17 DB	-50 DB	0 MA	24.00
LS-21	Single plate to push pull grids. Split primary and secondary	15,000 ohms	135,000 ohms; turn ratio 3:1 overall	20-20,000	+14 DB	-74 DB	0 MA	24.00
LS-22	Push pull plates to push pull grids. Split primary and secondary	30,000 ohms plate to plate	80,000 ohms; turn ratio 1.6:1 overall	20-20,000	+26 DB	-50 DB	.25 MA	31.00
LS-30	Mixing, low impedance mike, pickup, or multiple line to multiple line	50, 125, 200, 250, 333, 500/600 ohms	50, 125, 200, 250, 333, 500/600 ohms	20-20,000	+17 DB	-74 DB	5 MA	25.00
LS-30X	As above	As above	As above	20-20,000	+15 DB	-92 DB	3 MA	32.00
LS-27	Single plate to multiple line	15,000 ohms	50, 125, 200, 250, 333, 500/600 ohms	20-20,000 cycles	+20 DB	-74 DB	8 MA	24.00
LS-50	Single plate to multiple line	15,000 ohms	50, 125, 200, 250, 333, 500/600 ohms	20-20,000	+17 DB	-74 DB	0 MA	24.00
LS-51	Push pull low level plates to multiple line	30,000 ohms plate to plate	50, 125, 200, 250, 333, 500/600 ohms	20-20,000	+20 DB	-74 DB	1 MA	24.00
LS-141	Three sets of balanced windings for hybrid service, center-tapped	500/000 ohms	500/000 ohms	30-12,000	+10 DB	-74 DB	0 MA	28.00

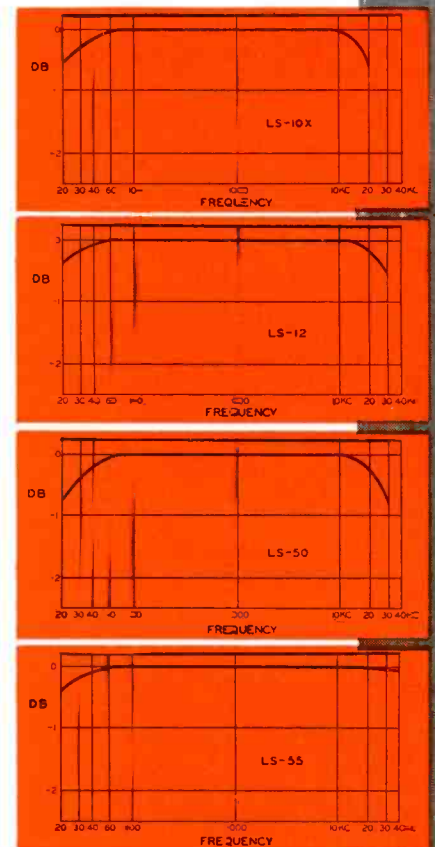

Write for our Catalog PS-510

TYPICAL LS OUTPUT TRANSFORMERS

Type No.	Primary will match following typical tubes	Primary Impedance	Secondary Impedance	± 1 db from	Max. Level	List Price
LS-52	Push pull 2A5, 250, 6V6, 42 or 2A5 A prime	8,000 ohms	500, 333, 250, 200, 125, 50, 30, 20, 15, 10, 7.5, 5, 2.5, 1.2	25-20,000	15 watts	\$28.00
LS-55	Push pull 2A3's, 6A5G's, 300A's, 273A's, 6A3's, 6L6's	5,000 ohms plate to plate and 3,000 ohms plate to plate	500, 333, 250, 200, 125, 50, 30, 20, 15, 10, 7.5, 5, 2.5, 1.2	25-20,000	20 watts	28.00
LS-57	Same as above	5,000 ohms plate to plate and 3,000 ohms plate to plate	30, 20, 15, 10, 7.5, 5, 2.5, 1.2	25-20,000	20 watts	20.00
LS-58	Push, pull parallel 2A3's, 6A5G's, 300A's, 6A3's	2,500 ohms plate to plate and 1,500 ohms plate to plate	500, 333, 250, 200, 125, 50, 30, 20, 15, 10, 7.5, 5, 2.5, 1.2	25-20,000	40 watts	50.00
LS-611	Push pull 6L6's self bias	9,000 ohms plate to plate	500, 333, 250, 200, 125, 50, 30, 20, 15, 10, 7.5, 5, 2.5, 1.2	25-20,000	30 watts	42.00

United Transformer Co.

150 VARICK STREET NEW YORK 13, N. Y.
EXPORT DIVISION: 13 EAST 40th STREET, NEW YORK 16, N. Y. CABLES: "ARLAB"



July • 1951

TESTING AIRCRAFT FUEL GAGES	COVER
Quality-control inspection of capacitance-type tank units for Simmonds Pacitron electronic fuel gage. Inner electrode profile can be designed to give linear gallon readings for almost any tank contour (see p 138)	
PRODUCTION PLANNING SPEEDS MILITARY ORDERS	82
Details of system that has enabled Sperry Gyroscope Company to double production per man hour since war	
HORIZONTALLY-POLARIZED OMNIDIRECTIONAL ANTENNA , by C. Brasse, Jr. and R. Thomas	86
Simple arrangement gives circular radiation pattern in 10-cm region	
COMMUNITY CIVIL DEFENSE COMMUNICATIONS PLAN , by Neal F. Harmon	88
Details by system now being set up in Onondaga County, N. Y., utilizing available radio facilities	
REMOTE CONTROL OF POSITIONING MOTORS , by George M. Chute	92
General-purpose follow-up circuit changes position of valve or other motor load when remote knob is turned	
AUTO-SEMBLY OF SUBMINIATURE MILITARY EQUIPMENT , by S. Danko and S. Lanzalotti	94
Etched wiring and dip soldering save labor, speed assembly, improve performance and cut cost of ultracompact circuitry	
AUTOMATIC TV SYNC LOCK , by L. M. Leeds	99
Special effects can be added to remote program when local sync generator is synchronized to remote generator	
CROWDED-BAND MOBILE EQUIPMENT , by H. H. Davids and T. J. Foster	102
Transmitter-receiver combination for operation in 148 to 174-mc range	
MILLIMICROSECOND OSCILLOGRAPHY , by Y. P. Yu, H. E. Kallmann and P. S. Christaldi	106
Distributed amplifiers and linear sweep generators permit viewing of millimicrosecond pulses	
SPEED-CONTROLLED SWITCH , by H. W. Kretsch and F. J. Walker	112
Thyratron circuit fed by a-c tachometer operates a relay at a preselected speed	
CONTINUOUS FILM SCANNER FOR TV	114
High-fidelity film picture source with electronic compensation for jitter and flicker	
CORRUGATED-WAVEGUIDE BAND-PASS FILTERS , by J. C. Greene	117
Rapid transition between pass and attenuation bands is provided by a waveguide section and corrugated surface	
BROADCAST TAPE SPEED CONTROL , by D. R. Andrews	120
Cut-off programs are avoided by playback that reproduces same interval as original magnetic-tape recording	
MEASURING VECTOR RELATIONSHIPS , by Y. P. Yu	124
Instrument measures complex components of an unknown voltage over frequency range of 8 cycles to 500 mc	
SQUARE-WAVE GENERATOR USING GATED-BEAM TUBE , by Louis E. Garner, Jr.	128
Pulses from 50 to 500,000 per second from five-tube generator 174-mc range	
TRANSISTOR FREQUENCY MODULATOR CIRCUIT , by L. L. Koros and R. F. Schwartz	130
Provides low-distortion modulation with reduced size, weight, and a-f and d-c power requirements	
BUSINESS BRIEFS	76
CROSSTALK	81
TUBES AT WORK	136
ELECTRON ART	140
NEW PRODUCTS	142
NEWS OF THE INDUSTRY	146
NEW BOOKS	150
BACKTALK	152
INDEX TO ADVERTISERS	(Last Page)

DONALD G. FINK, Editor; **W. W. MacDONALD**, Managing Editor; John Markus, Vin Zeluff, A. A. McKenzie, Associate Editors; William P. O'Brien, James D. Fahnestock, Ronald K. Jurgen, Assistant Editors; John M. Carroll (on Military Leave), Ann Mastropolo, Marilyn Wood, Editorial Assistants; Gladys T. Montgomery, Washington Editor; Harry Phillips, Art Director; Eleanor Luke, Art Assistant

KEITH HENNEY, Consulting Editor

H. W. MATEER, Publisher; **WALLACE B. BLOOD**, Manager; R. S. Quint, Buyers' Guide Manager; D. H. Miller, James Girdwood, New York; Wm. S. Hodgkinson, New England; Warren W. Shew, Philadelphia; C. D. Wardner, Chicago; J. L. Phillips, Cleveland; J. W. Otterson, San Francisco; J. H. Allen, Los Angeles; Ralph C. Maultsby, Atlanta; Bernard H. Butler, London, England



July, 1951

ELECTRONICS

Member AEC and ABP

Vol. 24, No. 7



Published monthly with an additional issue in June by McGraw-Hill Publishing Company, Inc., James H. McGraw (1860-1948), Founder. Publication Office, 99-129 North Broadway, Albany 1, N. Y.

Executive, Editorial and Advertising Offices: McGraw-Hill Building, 330 W. 42nd St., New York 18, N. Y. Curtis W. McGraw, President; Willard Chevalier, Executive Vice-President; Joseph A. Gerardi, Vice-President and Treasurer; John J. Cooke, Secretary; Paul Montgomery, Senior Vice-President, Publications Division; Ralph B. Smith, Editorial Director; Nelson Bond, Vice-President and Director of Advertising; J. E. Blackburn, Jr., Vice-President and Director of Circulation.

Subscriptions: Address correspondence to Electronics—Subscription service, 99-129 N. Broadway, Albany 1, N. Y., or 330 W. 42nd St., New York 18, N. Y. Allow ten days for change of address. Please indicate position and company connection on all subscription orders.

Single copies 75¢ for United States and possessions, and Canada; \$1.50 for Latin America; \$2.00 for all other foreign countries. Buyers' Guide \$2.00. Subscription rates—United States and possessions, \$6.00 a year; \$9.00 for two years; \$12.00 for three years. Canada, \$10.00 a year; \$16.00 for two years; \$20.00 for three years. Pan American countries, \$15.00 a year; \$25.00 for two years; \$30.00 for three years. All other countries \$20.00 a year; \$30.00 for two years; \$40.00 for three years. Entered as second class matter August 29, 1936, at the Post Office at Albany, N. Y., under act of Mar. 3, 1879. Printed in U. S. A. Copyright 1951 by McGraw-Hill Publishing Co., Inc.—All Rights Reserved. BRANCH OFFICES: 520 North Michigan Avenue, Chicago 11, Ill.; 68 Post Street, San Francisco 4; Aldwych House, Aldwych, London, W.C. 2; Washington, D. C. 4; Philadelphia 3; Cleveland 15; Detroit 26; St. Louis 8; Boston 16; Atlanta 3, Ga.; 1111 Wilshire Blvd., Los Angeles 17; 738-9 Oliver Building, Pittsburgh 22. ELECTRONICS is indexed regularly in The Engineering Index.

marion methods

electrify

TWEEZER SOLDERING

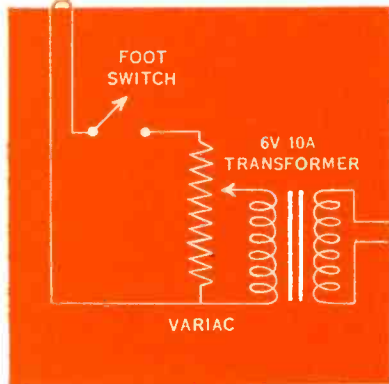
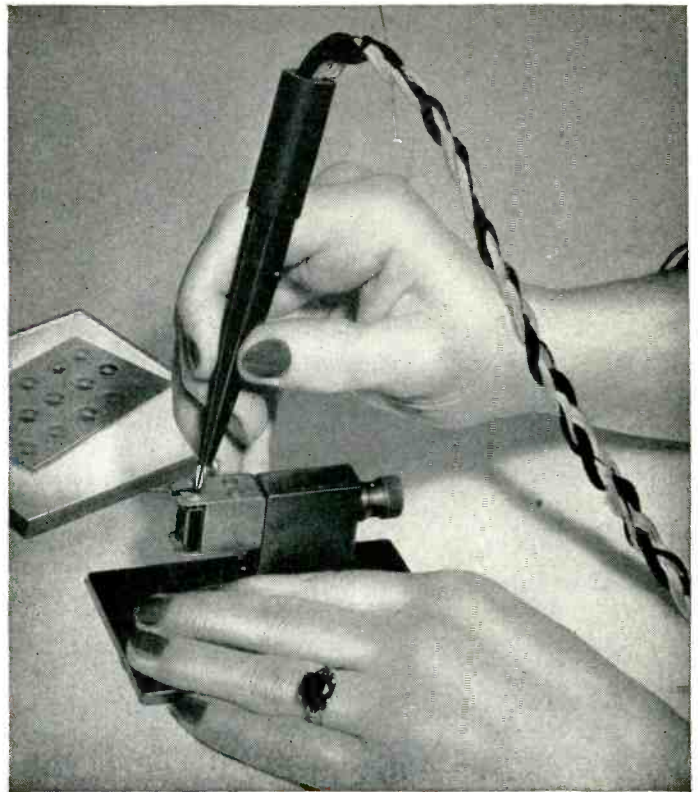

Electrified by Marion, these tweezers now do double duty. They position the work and solder it at the same time. Tripled production and finer fluxless joints result.

Help yourself to marion methods

MARION USES THIS METHOD of Tweezer Soldering for precise hairspring soldering, positioning small metal parts in thermoplastic cements, and in other fine soldering operations. Resistance heating in the work itself and conducted heat from the tips combine to give greatly increased soldering rates on pretinned components. Because the tweezers develop little heat themselves, adjacent component damage is avoided. These tweezers permit an inexperienced worker to rapidly acquire a high degree of skill. Both positioning and soldering are combined with the handling ease of a fountain pen.

NOT FOR SALE — You can make electric soldering tweezers of your own. Those shown here have standard "MM" blades, separated and insulated by bakelite. They are assembled and wired as illustrated. By varying the voltage, the tip cross-section, and the contact area, you can adapt this tool to your specific application.

OTHER MARION METHODS — Current demands on industry by the mobilization program accentuate the importance of production methods. Electric tweezer soldering is only one of a number of methods which Marion proposes to present in the hope that some of them can help you as much as they have helped us. Marion Electrical Instrument Company, 401 Canal Street, Manchester, N. H., U. S. A.

FLEXIBLE BRAIDED CONDUCTORS.
APPROX. EQUIV. #10 B. & S.

SILVER SOLDERED
TANTALUM-TUNGSTEN TIPS
SHAPED FOR OPERATION REQUIREMENTS

STANDARD "MM" TWEezer BLADES

INSULATOR



MANUFACTURERS OF MARION RUGGEDIZED PANEL INSTRUMENTS

marion meters

MUIRHEAD

1951

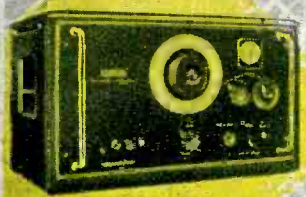
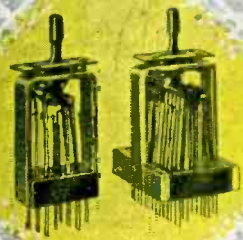
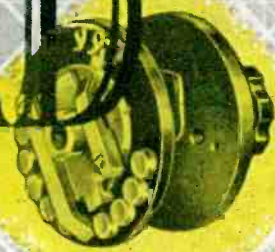
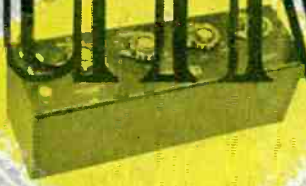

10 ~ 100 ~ 1000 ~ 10k/cf ~ 100k/cf ~ 1Mc/cf ~ 10Mc/cf

MUIRHEAD & CO. LTD.
BECKENHAM · KENT · ENGLAND

NAME _____
COMPANY _____
POSITION _____

MAILING ADDRESS _____

*Please send me, free of charge, your
1951 CATALOGUE.*

Compactness

for
resistors

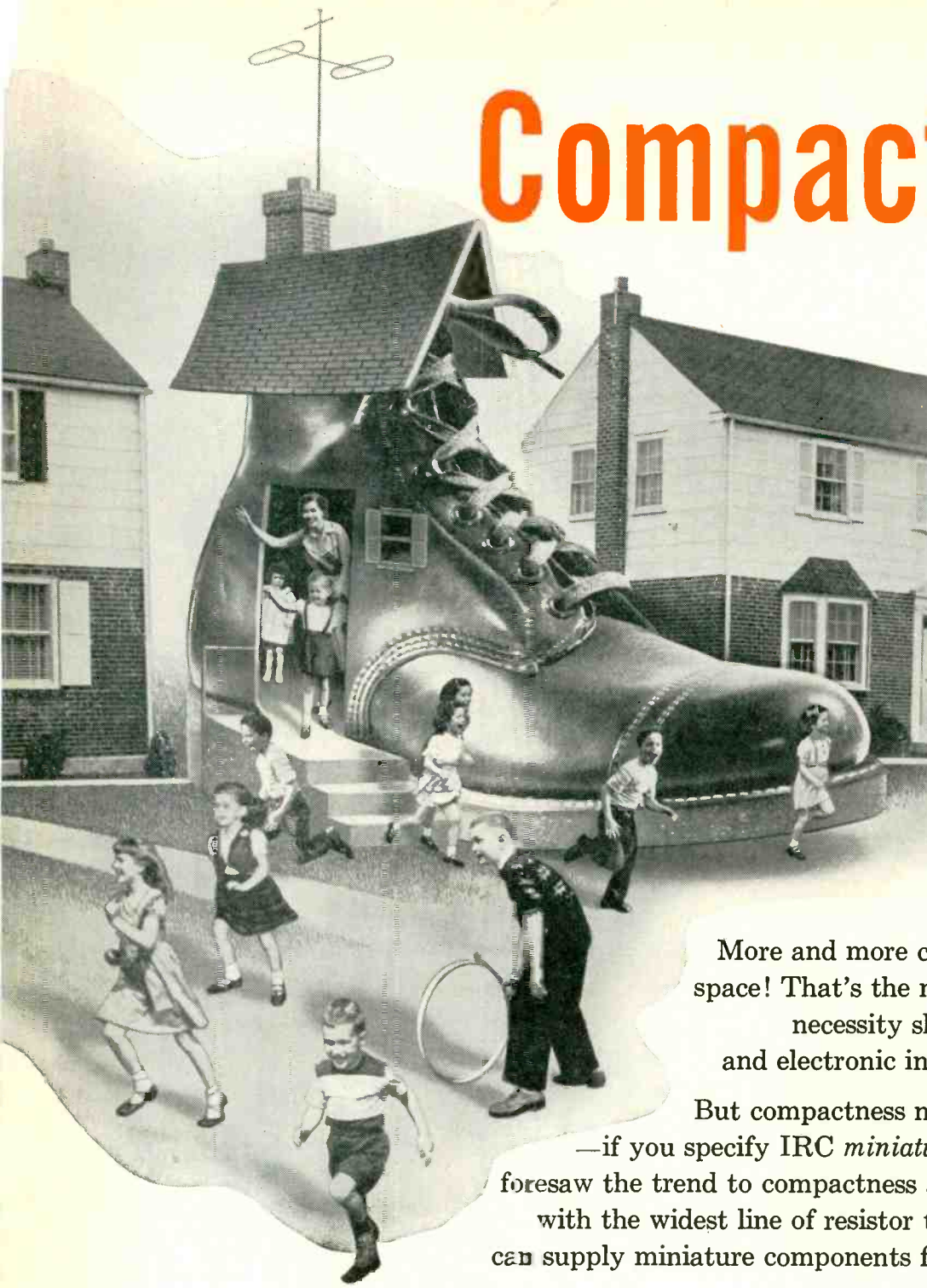

More and more components in less and less space! That's the manufacturer's dilemma as necessity shrinks the size of electrical and electronic instruments and equipment.

But compactness need not create bottlenecks —if you specify IRC *miniature resistors*. Years ago, we foresaw the trend to compactness and got ready for it. Now, with the widest line of resistor types in the industry, IRC can supply miniature components for almost any application.

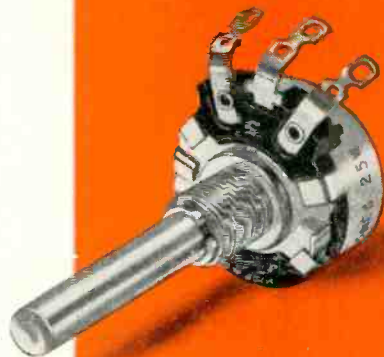

Only $15/16$ " in diameter, compact new IRC Type Q Controls adapt to a wide variety of small-space applications. Rugged construction features one-piece dual contactor of thin, high-stress alloy—simplified single-unit collector ring—molded voltage baffles—special brass element terminals that will not loosen or become noisy when bent or soldered. Salt-spray materials, when specified, protect against humidity; change in resistance is negligible even after long exposure. Noise level is low and Type Q Controls have unusual durability and efficiency. Coupon brings you full details in Catalog A-4.

is essential

too!

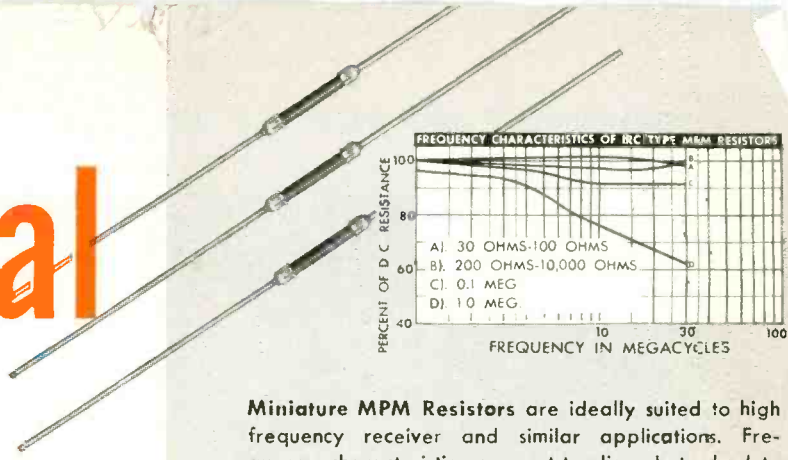

Miniature MPM Resistors are ideally suited to high frequency receiver and similar applications. Frequency characteristics are outstanding, but absolute balance has been maintained with all other significant electrical characteristics. These are the same as in larger IRC Type MP Resistors. MPM's are constructed of solid steatite ceramic rods, to which a thin resistance film is permanently bonded. Changes due to humidity and aging are held to a minimum. Resistor body is 1/16" long, and active resistance section only 3/8" long. Send for complete information in Catalog F-1.

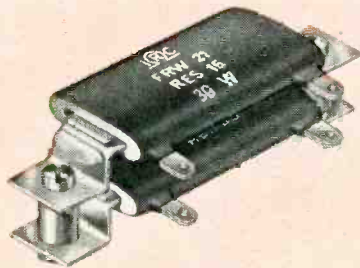

Higher space-power ratio than tubular wire winds suits small, flat Type FRW fixed and adjustable wire winds to voltage dropping applications in limited space. FRW's may be mounted vertically or horizontally, singly or in stacks. Non-magnetic mounting brackets extend through resistors—allow easy and economical mounting—aid in heat distribution along entire length—and transfer internal heat to chassis. Light-weight construction combines with exceptional mechanical strength and ability to withstand severe vibration. Bulletin C-1 gives full performance data.

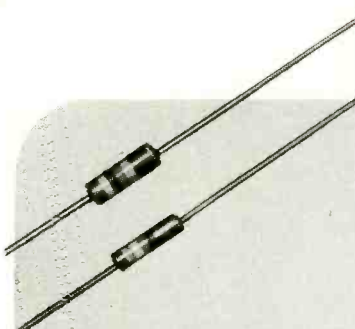

Tiny fixed composition resistors—Types BTR and BTS—are only 1/8" in body length. At 1/8 and 1/4 watts, respectively, these miniature units set new performance standards for fixed composition resistors. Advanced BT's easily meet the rigorous requirements of television—actually exceed JAN-R-11 Specifications! Balanced in every characteristic, BT's are especially well suited to high ambient temperatures. Power dissipation is excellent. Other Advanced Type BT's meet and surpass JAN-R-11 Specifications at 1 and 2 watts. Write for full particulars in Catalog B-1.

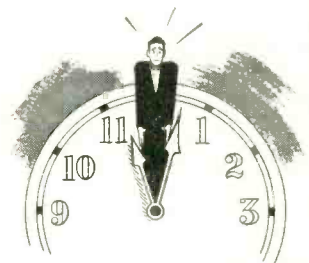

When you're squeezed for "small-orders" of standard resistors in a hurry, simply call your IRC Distributor. IRC's Industrial Service Plan enables him to give you fast, 'round-the-corner delivery of standard resistors for experimental work, pilot runs, maintenance. We'll be glad to send you his name and address.



Wherever the Circuit Says

- Power Resistors • Voltmeter Multipliers
- Insulated Composition Resistors • Low Wattage Wire Wounds • Volume Controls • Voltage Dividers • Precision Wire Wounds • Deposited Carbon Precistors • Ultra-HF and High Voltage Resistors • Insulated Chokes

INTERNATIONAL RESISTANCE COMPANY
 PHILADELPHIA 3, PENNSYLVANIA
 International Resistance Company,
 Toronto, Ontario

INTERNATIONAL RESISTANCE COMPANY A
 403 N. Broad St., Phila. 8, Pa.

Send me additional data on the items checked below:—

Q Controls Flat FRW Resistors

Advanced BT Resistors MPM Resistors

Name and Address of local IRC Distributor

NAME

TITLE

COMPANY

ADDRESS

THOMPSON EXPANDS ITS SERVICE INTO ELECTRONIC PRODUCTION



Model No. 10829 one-pole two-throw coaxial switch.

new!

precision built
coaxial switches

BY

Thompson



Model No. 10567 one-pole four-throw coaxial switch.

TYPICAL PERFORMANCE

- Frequency range, 0 to 10,750 Mc./Sec.
- V. S. W. R., 1.5 maximum
- Insertion loss, .5 decibels or less at 3,000 Mc./Sec.
- Cross-talk, 50 decibels minimum at 3,000 Mc./Sec.
- Characteristic impedance, 50 ohms nominal
- Maximum RF voltage, 500 volts RMS
- Power rating, CW maximum continuous 100 watts at 3,000 Mc./Sec.

THESE SWITCHES are available in several types, including single pole 2-throw, 3-throw, 4-throw and 6-throw, double pole double-throw, and lobing or sensing. Remote actuation is available for all.

The Thompson Products Electronics Division has a competent staff of engineers, electronic and environmental test equipment, model shop facilities, and production facilities ready to work with you on your coaxial switch problems.

WRITE for further technical information and descriptive brochure. Your inquiry will bring a prompt reply.



ELECTRONICS DIVISION, 2196 CLARKWOOD ROAD, CLEVELAND 3,

Thompson  **Products, Inc.**

MANUFACTURERS OF PRECISION AIRCRAFT PARTS AND ACCESSORIES
CLEVELAND • DETROIT • LOS ANGELES • ST. CATHARINES, ONTARIO

INTERNATIONAL
RESISTANCE
PHILADELPHIA
In Canada: International
Ltd.

Plasticon GLASSMIKES

have been solving your
engineering problems since 1943!

We originally designed Glassmikes for the Metallurgical Laboratory at the University of Chicago for use in radiation counter equipment. The Glassmike construction (metal ferrules soldered to silvered bands at each end of a glass tube) proved ideal for small, high voltage filter and coupling capacitors. As the only exclusive producers of plastic film dielectric capacitors, we use many different films and impregnation combinations. Our application experience enables us to recommend the best dielectric combination for your particular application.

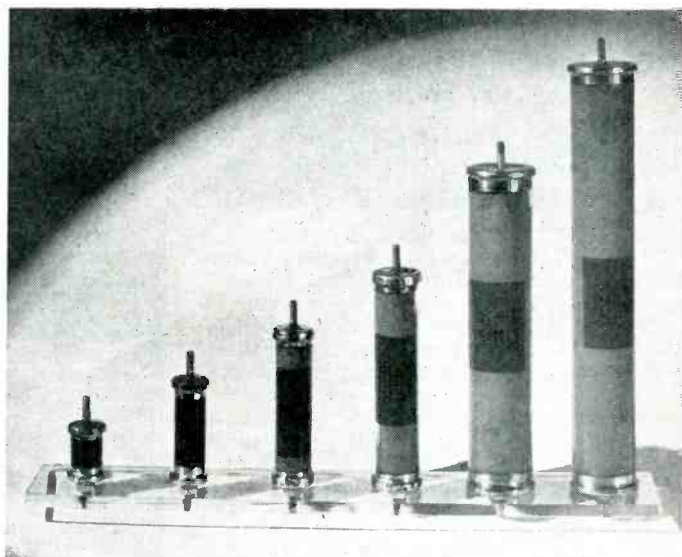

Some of the more common Glassmike types are as follows:

Type ASG—High temperature, high voltage filter coupling and by-pass service.

Type AAG—High resistance, low voltage coupling and storage service.

Type LAG—Very high resistance, extremely low dielectric absorption.

Type LSG—High "Q", high voltage replacement for mica capacitors.

Type TAG—Similar applications to Type LAG, but for higher temperatures.

Type TSG—Similar application to Type LSG, but for higher temperatures.

Type PAG—High DC resistance, low dielectric absorption for temperatures up to 85° C.

Type FAG—Ultra high resistance, high voltage capacitor.

Send us your requirements and we will recommend the proper capacitor.

MANUFACTURERS

Glassmike Capacitors

Plasticon Capacitors

HiVolt Power Supplies

Putse Forming Networks

All Phones: **AMbassador 2-3727**

Condenser Products Company



7517 North Clark Street • Chicago 26, Illinois

features GLASTIC

The fiberglass-polyester laminate that provides greater insulation protection per dollar cost

GLASTIC Laminates are made by combining glass fibers with alkyd base polyester resins . . . the resultant laminate, combining the best electrical and physical features of both, is an insulating material significantly superior in heat, arc and moisture resistance; flexural, impact and tensile strength . . . also it is tough, rigid and dimensionally stable. GLASTIC Laminates are easy to fabricate; they punch and shear without requiring pre-heating.

GLASTIC Laminates are available in six grades to meet all known insulation requirements:		MECHANICAL AND ELECTRICAL PROPERTIES	GRADE MM	GRADE GF	GRADE GW
GLASTIC MM	Distinctly superior to cotton fabric reinforced phenolic laminates and similar materials, yet competitive in price.	Flexural Strength (psi)	23,800	34,000	53,200
GLASTIC GF	Similar to Glastic MM but made with a resin of greater strength and flame resistance; well suited to resist pounding, required in driving slot wedges.	Rigidity (Young's Mod. x 10¹⁰)	1.87	2.84	3.38
		Impact Strength (Izod)	13.5	19.2	25.0
GLASTIC GW	Premium grade, much greater strength than either MM or GF; 45,000 psi at 150°C after 200 hours; requires sharp carbide tools in fabricating.	Tensile Strength (psi)	11,100	17,300	44,500
		Compressive Strength (psi)	33,500	53,100	57,500
GLASTIC GU	Similar to GW but uses unidirectional glass cloth for maximum tensile strength in one direction (70,000 psi).	Hardness (Rockwell M)	90	90	90
		Specific Gravity	1.59	1.51	1.75
GLASTIC MP	Tough, semi-rigid sheet stock available in .038" nominal thickness only; well suited to cold shearing and punching.	Water Absorption (% ASTM)	.54	.36	.61
		Arc Resistance (ASTM)	150	60	120
GLASTIC A FLEXIBLE	Tough and thin; will crease without serious loss in dielectric (500-700 V/M); shearing and handling qualities far superior to mica glass materials; will not puff or distort regardless of long storage under heat or humidity; standard thicknesses .015" and .020"	Dielectric Strength (V/M)	300	280	210
		Dielectric Constant (at 60 cy.)	4.3	4.1	5.4
		Power Factor (% at 60 cy.)	3.1	2.4	11.2
		AFTER 200 HRS. Exposure at 150°C.			
		Flexural Strength (psi)	25,200	32,200	45,000
		Impact Strength (Izod)	15.7	25.2	22.0
		Dielectric Strength (V/M)	325	315	200
		Water Absorption (% ASTM)	1.32	.61	2.15

GRADE B INSULATION FOR THE PRICE OF GRADE A

GREATER

**IMPACT STRENGTH
ARC RESISTANCE
HEAT RESISTANCE
DIMENSIONAL STABILITY
MOISTURE RESISTANCE**

- MOLDED GLASTIC parts, Grade MG, are available to specification.
- Special GLASTIC for particular requirements will be developed on request.
- Information detailing the superiority of GLASTIC with grade C phenolics and melamine G5 laminates is available . . . Write for GLASTIC bulletin MR; also for free test samples—they'll be sent upon written request.

Write for GLASTIC bulletin MR; also for free test samples



MITCHELL-RAND INSULATION CO.,

51 MURRAY STREET

COrtlandt 7-9264

NEW YORK

A PARTIAL LIST OF M-R PRODUCTS: FIBERGLAS VARNISHED TUBING, TAPE AND CLOTH • IN AND TWINES • CABLE FILLING AND POTHEAD COMPOUNDS • FRICTION TAPE AND SPLICE • T POUNDS • FIBERGLAS SATURATED SLEEVING • ASBESTOS SLEEVING AND TAPE • VARNISHED C TAPE • MICA PLATE, TAPE, PAPER, CLOTH, TUBING • FIBERGLAS BRAIDED SLEEVING • COTTON T SLEEVINGS • IMPREGNATED VARNISH TUBING • INSULATING VARNISHES OF ALL TYPES • EXTR

Noise Suppression?

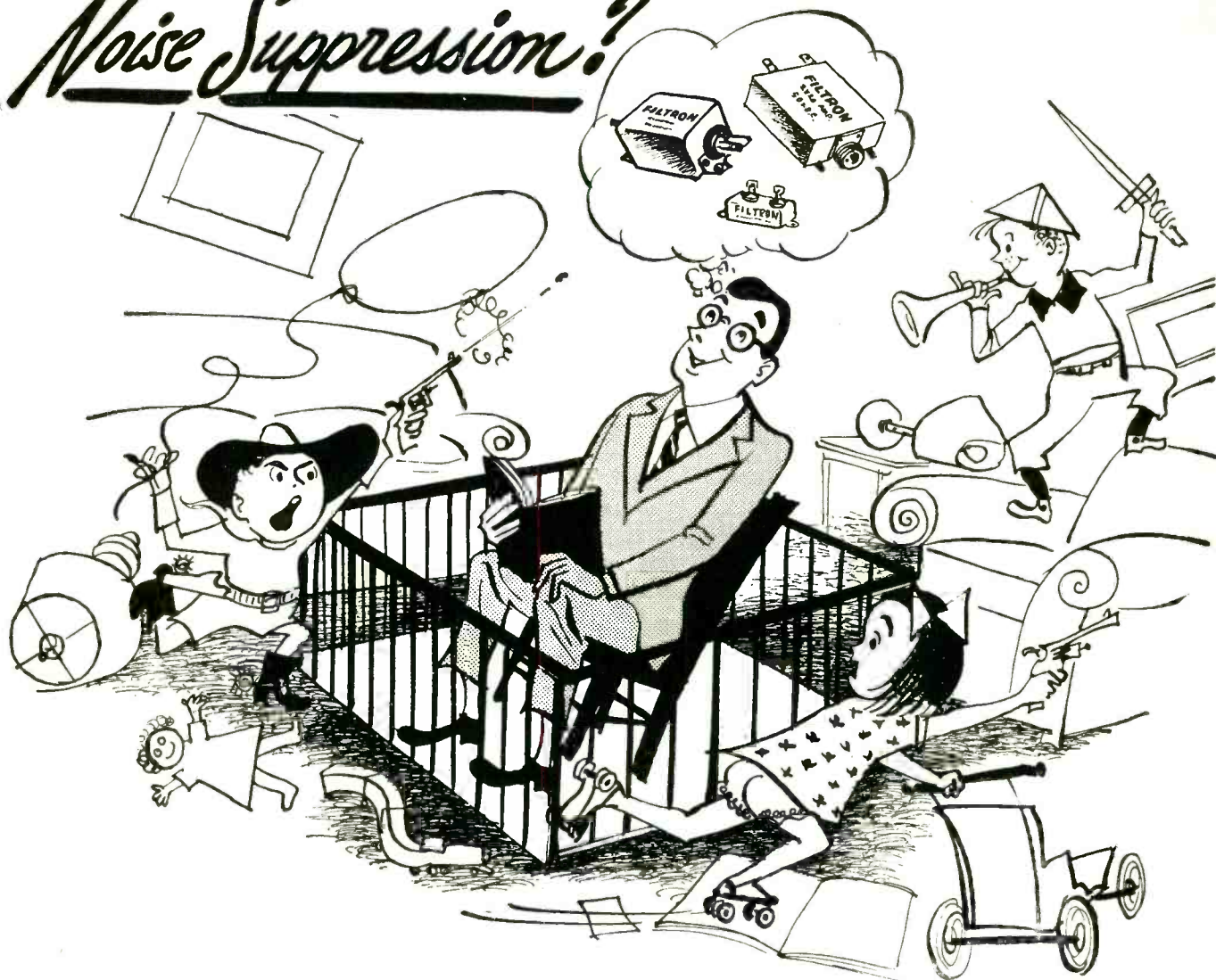

Engineers think of FILTRON for noise suppression!

FILTRON might not be able to lick the problem shown above, but we can solve all of your problems of RF Interference Suppression on electronic equipment.

FILTRON will design the right filter for your circuit conditions to meet size, weight and electrical characteristics — and meet RF Interference Sup-

pression Specifications wherever RF Interference must be eliminated.

FILTRON's advanced engineering, due to constant research and development, together with FILTRON's production know-how, insures quality components to meet your delivery requirements.

RF INTERFERENCE SUPPRESSION FILTERS FOR:

Motors	Dynamotors
Generators	Power Plants
Inverters	Actuators
Electronic Controls	Gasoline Engines

And other RF Interference producing equipment

filtered by **FILTRON**



LOCKHEED XF-90

Send for your copy of our NEW CATALOG on your company letterhead.

THE FILTRON CO., INC.
FLUSHING, LONG ISLAND, N. Y.

LARGEST EXCLUSIVE MANUFACTURERS OF RF INTERFERENCE FILTERS

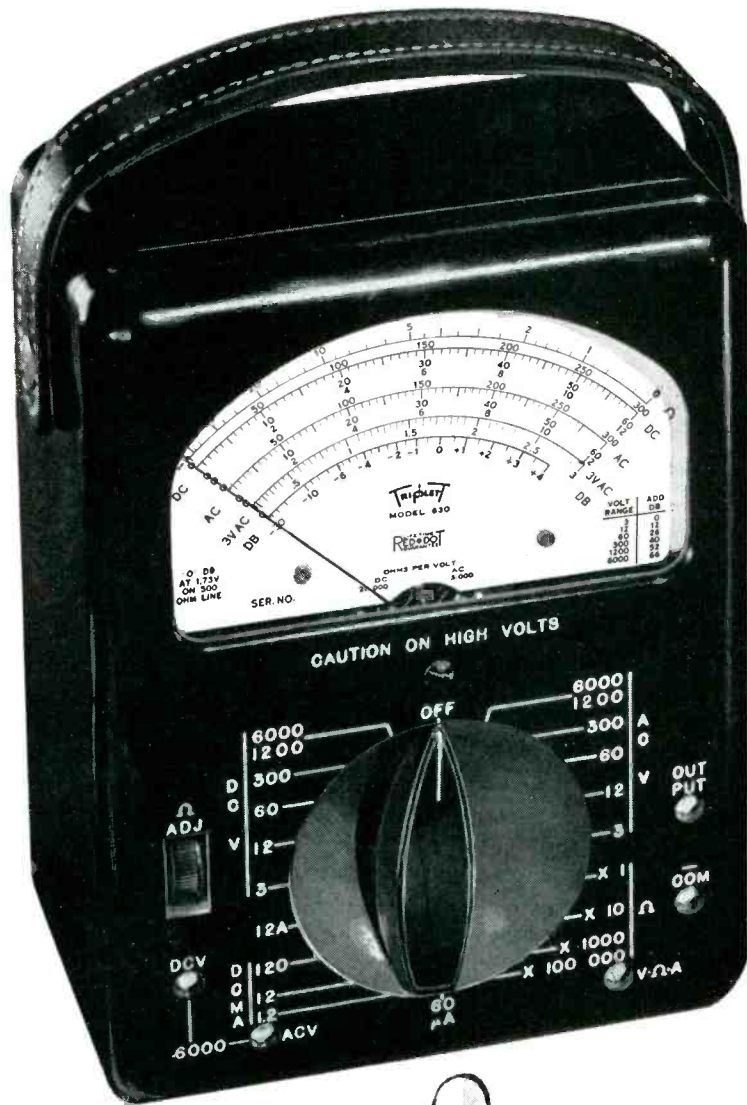

ALL RANGES WITH THIS ONE CONTROL

Just *one* knob—extra large—easy to turn—flush with the panel, controls all ranges. This one knob saves your time—minimizes the chances of “burn-outs” because you don’t have to remember to set another control. You can work fast with Model 630 with your eyes as well as your hands. Look at that scale—wide open—easy to read, accurately. Yes, this is a *smooth TV* tester. Fast, safe, no projecting knobs, or jacks, or meter case. Get your hand on that single control and you’ll see why thousands of “Model 630’s” are already in use in almost every kind of electrical testing

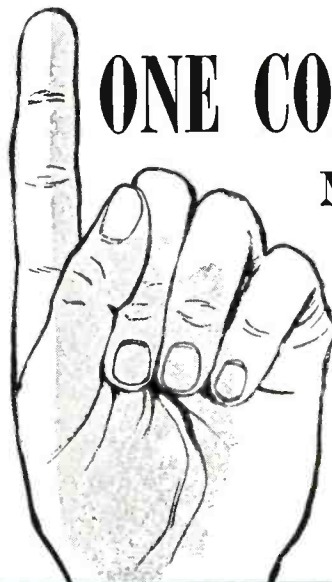

**Model
630**

FOR THE MAN WHO TAKES PRIDE IN HIS WORK

Triplet

TRIPLET ELECTRICAL INSTRUMENT COMPANY • BLUFFTON, OHIO, U. S. A.

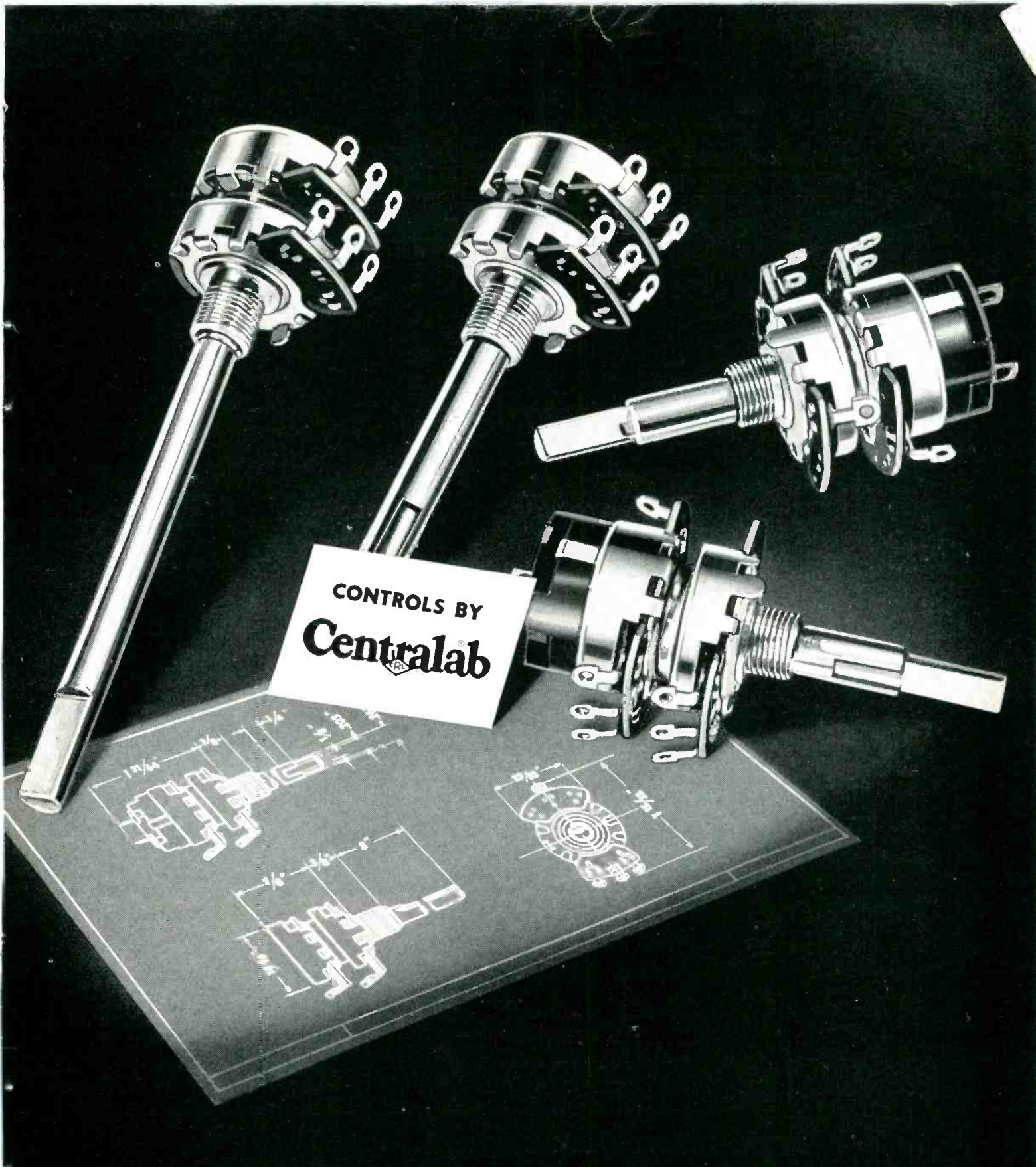

CONTROLS BY
Centralab

Nowhere can you obtain a broader variety of finer quality controls than those made by Centralab—the Company which introduced carbon controls to the electronic industry more than 25 years ago!

For more information see next two pages →

SPECIFY CENTRALAB CONTROLS FOR

CENTRALAB OFFERS A VARIETY OF STANDARD AND CUSTOM

Centralab's New Model 2 Radiohm

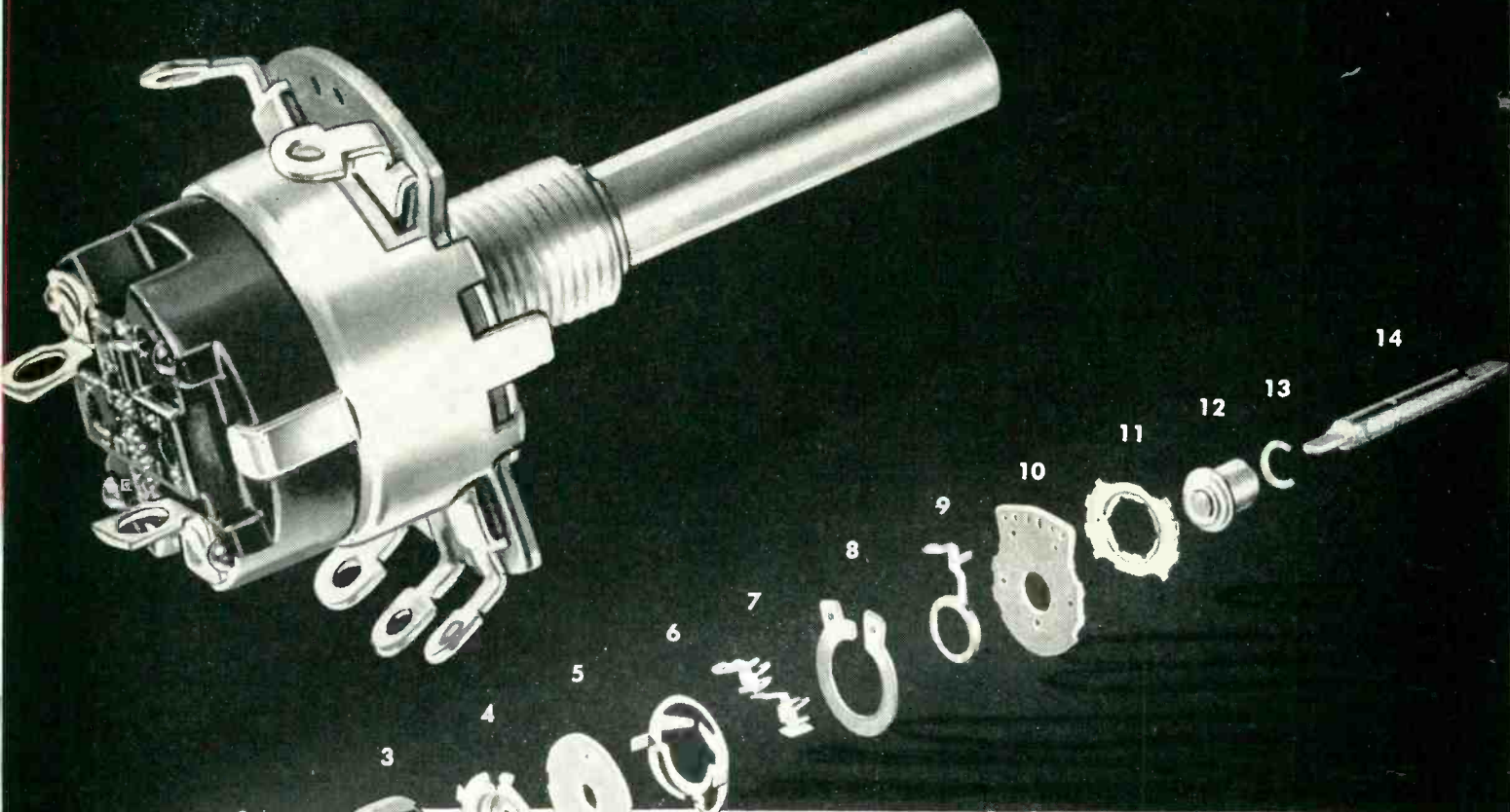

14 Good Reasons Why CRL'S Model 2 Radiohm is the Control for You!

- 1. Resistor:** Velvet smooth, low noise level operation with CRL's *exclusive*, chemically developed resistance material. Thirteen standard tapers.
- 2. Resistor base:** Resistance material bonded to laminated, phenolic base. Base maintains high insulation resistance in high humidity.
- 3. Contact spring:** Phosphor-bronze. Double wiping. Uniform mechanical pressure and positive electrical contact on resistor element and contact ring assures noiseless action.
- 4. Shoe:** High grade, laminated phenolic. High insulation resistance in humidity.
- 5. Center terminal:** Cadmium tipped, non-oxidizing. Easily soldered.
- 6. Terminals:** Clinch type, tightly crimped to resistor element for mechanical rigidity and electrical continuity when soldered or in humidity.
- 7. Ground plate:** Cadmium plated steel.
- 8. Bushing:** Cadmium plated steel. Accurately machined for minimum shaft-bushing clearance, smooth rotation.
- 9. Shaft:** Many variations meet diversified application. Round, Flatted, Slotted, Split knurl, Finger tip knurl. Also nylon for high voltage application.
- 10. Cover:** Cadmium plated steel, completely shields resistor element.
- 11. Switch:** Directly operated from shaft. Positive on and off action. Standard, high and low current ratings in varied combinations.
- 12. Switch terminals:** Ends shaped for wrap-around leads. Hot tin-dipped for easy soldering. Mechanically anchored — will not loosen during soldering operations. Surfaces elevated; cannot short to cover legs.
- 13. Insulator:** High dielectric strength permits breakdown rating of 1,000 volts, R.M.S.
- 14. Variety of unit types:** Single or twin, concentric shaft twins, plain or switch type, any of these tapped or untapped. Simple design permits wide variation at minimum cost.

YOUR AM—FM—TV APPLICATIONS

SPECIFICATIONS TO MEET COMMERCIAL AND GOVERNMENT REQUIREMENTS

Famous new Centralab Model 2 Radiohms now available in plain or switch types—standard or custom designs—with plain or dual concentric shafts. $15/16$ " control diameter meets today's demand for smaller size.

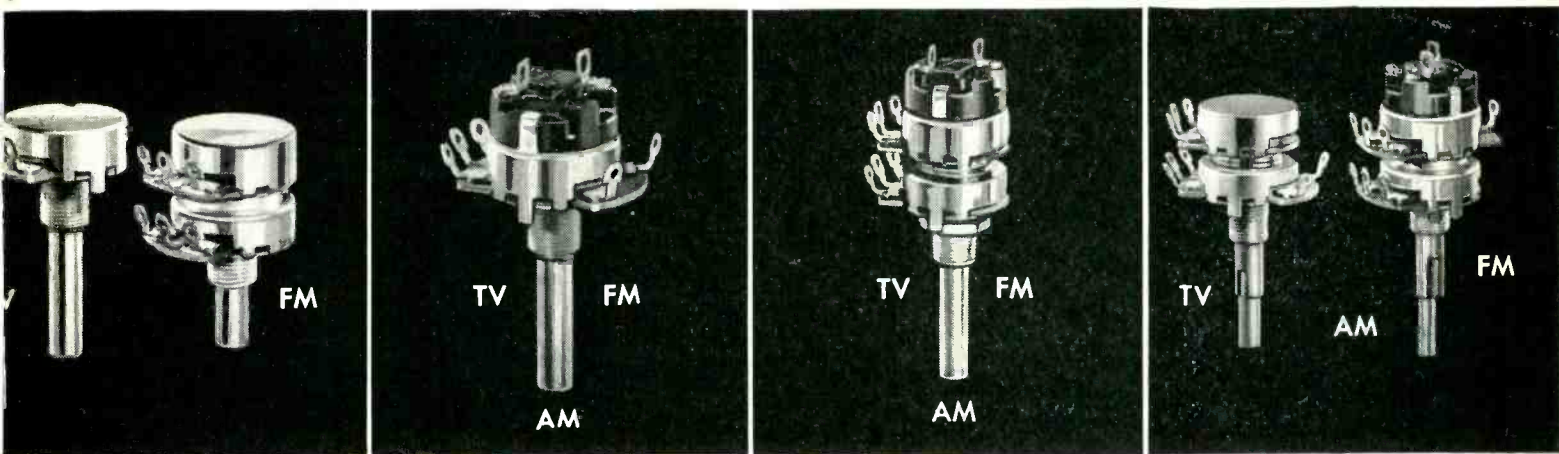

New Centralab Model 2 Radiohm Control — Left, single unit plain type, untapped; right, twin unit plain type, untapped. Both with single shafts.

New Centralab Model 2 Radiohm Control—control shown is a single unit switch type, tapped. Control has single shaft.

New Centralab Model 2 Radiohm Control — this control is a twin unit switch type, untapped. It has a single shaft.

New Centralab Model 2 Radiohm Control — Left, twin unit plain type, front section tapped; right, twin unit switch type, rear section tapped. Both units have concentric shafts.

OF SPECIAL INTEREST.....

The World's Smallest Volume Control — Centralab's Model 1



Smaller than a dime! Less than $1/4$ " thick.
Available in plain or switch type.
Ideal for miniature electronic gear.

FOR COMPLETE SPECIFICATIONS AND SAMPLES

If you want further information — taper curves, physical dimensions, engineering specifications on Centralab's Model 2 Radiohms or Model 1's, mail in coupon below. *Manufacturer's samples on request.*

Centralab

Division of GLOBE-UNION INC. • Milwaukee

Centralab Div. Globe-Union Inc.
914 E. Keefe Ave., Milwaukee 1, Wis.

Please send me Control bulletin No. 42-85 on Centralab Model 2 Radiohms. Also include Control bulletin No. 42-19 on Centralab's Model 1 miniature control.

Name.....Title.....

Company.....Address.....

City.....Zone.....State.....

For Negative Resistance-Voltage Characteristics

GLOBAR

TRADE MARK

TYPE BNR RESISTORS

Typical applications where these resistors operate successfully include:

- 1 Small motors to prevent arcing of governor contact points.
- 2 Stabilizing rectifier circuits by limiting peak voltages.
- 3 Voltage control circuits in electronic devices.
- 4 Protection of solenoids in direct current circuits.

Responding instantly to voltage changes, GLOBAR type BNR Silicon Carbide Resistors provide increased resistance as a potential is decreased. Conversely, as a potential is applied, resistance decreases. These resistors are what is commonly referred to as voltage sensitive. They are used to dampen the effect of transient voltages and provide instant protection for electrical circuits.



Bulletin GR2 contains useful engineering data on GLOBAR BNR Ceramic Resistors. Copies will be supplied immediately upon request. Write Dept. V-71, The Carborundum Company, GLOBAR Division, Niagara Falls, N. Y.

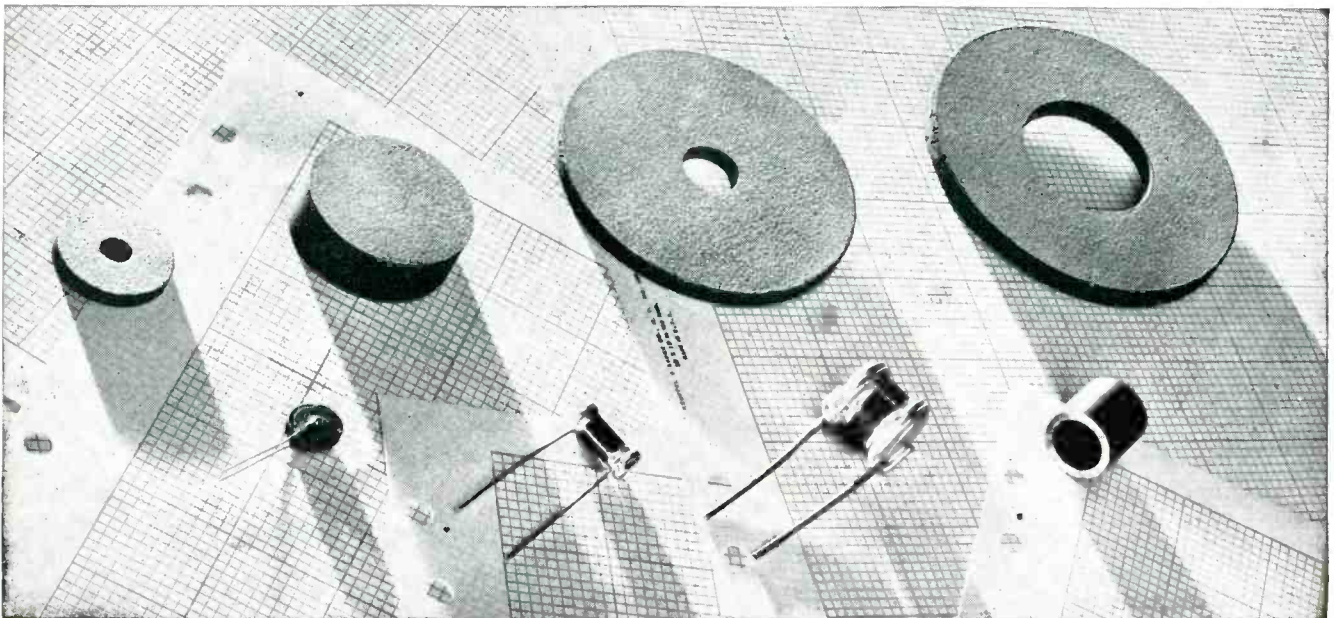

Resistors of this type are readily made to meet exact specifications. Working samples are available when necessary. To be sure of receiving resistors made to correct specifications, the following information should be furnished:

- a. Type of apparatus in which resistors are to be used.
- b. Method of mounting and space limitations.
- c. Normal operating voltage and peak voltage if available.
- d. Resistance and inductance of the circuit if available.
- e. Ohmic resistance of the resistor and allowable plus or minus tolerance.
- f. Maximum voltage applied continuously or intermittently.
- g. Duration of load and elapse of time between applications.

Furnishing these data will also avoid unnecessary delay and confusion.

GLOBAR Ceramic Resistors

BY CARBORUNDUM

TRADE MARK



"Carborundum" and "Globar" are registered trademarks which indicate manufacture by The Carborundum Company, Niagara, Falls, N. Y.

hp OFFERS

COMPLETE COVERAGE

1. ..in electronic test instrumentation..

Today, *-hp-* offers complete instrumentation for virtually every type of electronic measuring. For audio work, *-hp-* oscillators and generators, 1/2 to 10,000,000 cps. For voltage measurements, vacuum tube voltmeters (ac and battery) 2 to 700,000,000 cps. For VHF, UHF and SHF, signal generators 10 to 7,600 mc. For microwave, a broad-band line covering all coaxial and 6 most-used waveguide frequencies. For microwave impedance and power measurements, complete new instrumentation, 10 to 12,400 mc. For frequency measurement, standards, monitors and cycle counters, .01 to 200 mc. These and more—over 200 fast, accurate, easy-to-use instruments—the world's most complete coverage of electronic measuring needs.

2. ..in convenient, "next-door" service..

-hp- has selected the best independent organizations in America to give you person-to-person help with your measuring problems. You are served by electronic specialists—men trained by Hewlett-Packard, fully informed about all *-hp-* instruments. These men save your time by helping select exact instrumentation you require. They can offer expert counsel on your measuring problems. They are located in major business centers, as near to you as your telephone. Call them whenever, *wherever* you need personal help, in your plant, *today!*

The *-hp-* field service program saves time!

The *-hp-* direct-to-you sales policy saves money!

HEWLETT-PACKARD COMPANY

2309A PAGE MILL ROAD • PALO ALTO, CALIFORNIA, U.S.A.

Export: Frazar & Hansen, Ltd., San Francisco, Los Angeles, New York

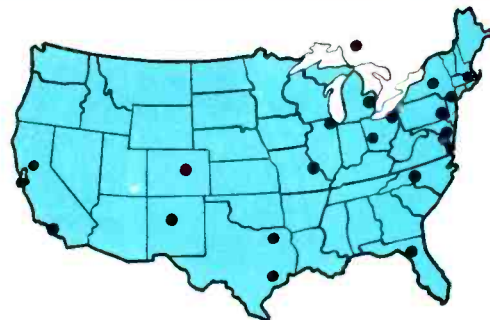

**There is a trained
-hp- representative near you!**

Albuquerque, New Mexico

Neely Enterprises
107 S. Washington St.
Albuquerque 5-8731

Boston 16, Massachusetts

Burlingame Associates
270 Commonwealth Ave.
KENmore—6-8100

Chicago 40, Illinois

Alfred Crossley & Associates
4501 N. Ravenswood Ave.
UPTown 8-1141

Cleveland 15, Ohio

M. P. Odell Co.
2536 Euclid Ave.
PRespect 1-6171

Dallas 5, Texas

Earl Lipscomb Associates
3561 Marquette St.
P. O. Box 8042
EMerson 6-7989

Dayton 2, Ohio

Alfred Crossley & Associates
410 W. First St.
Michigan 8721

Denver 3, Colorado

Ronald G. Bowen
852 Broadway
AComa 5211

Detroit 5, Michigan

S. Sterling Company
13331 Linwood Ave.
TOWnsend 8-3130

Fort Myers, Florida

Arthur Lynch & Associates
P. O. Box 466
Fort Myers 5-6762

High Point, North Carolina

Bivins & Caldwell
Room 807, Security Bank Bldg.
High Point 3672

Houston 5, Texas

Earl Lipscomb Associates
2420-B Rice Blvd.
P. O. Box 6573
LInden 9303

Los Angeles 46, California

Neely Enterprises
7422 Melrose Ave.
WHITney 1147

New York 13, New York

Burlingame Associates
103 Lafayette St.
Digby 9-1240

Philadelphia 44, Penn.

Burlingame Associates
422 West Coulter St.
TEnnessee 9-2006

Sacramento, California

Neely Enterprises
309 Ochsner Bldg.
GI lbert 3-7461

San Francisco 18, California

Neely Enterprises
2830 Geary Blvd.
WAlnut 1-3960

St. Louis 3, Missouri

Harris-Hanson Company
208 North 22nd Street
MAIn 5464

Syracuse 2, New York

Burlingame Associates
712 State Tower Bldg.
SYRacuse 2-0194

Toronto 2-B Ontario, Canada

Atlas Radio Corporation, Ltd.
560 King St., West
WAVerley 4761

Washington 9, D. C.

Burlingame Associates
2017 S Street N. W.
DEcatur 8000

HEWLETT-PACKARD  INSTRUMENTS

WORKING WITH VIDEO?

Crystal-positioned
pulse type
frequency marks

Excellent amplitude
linearity —
less than .1 db/mc.

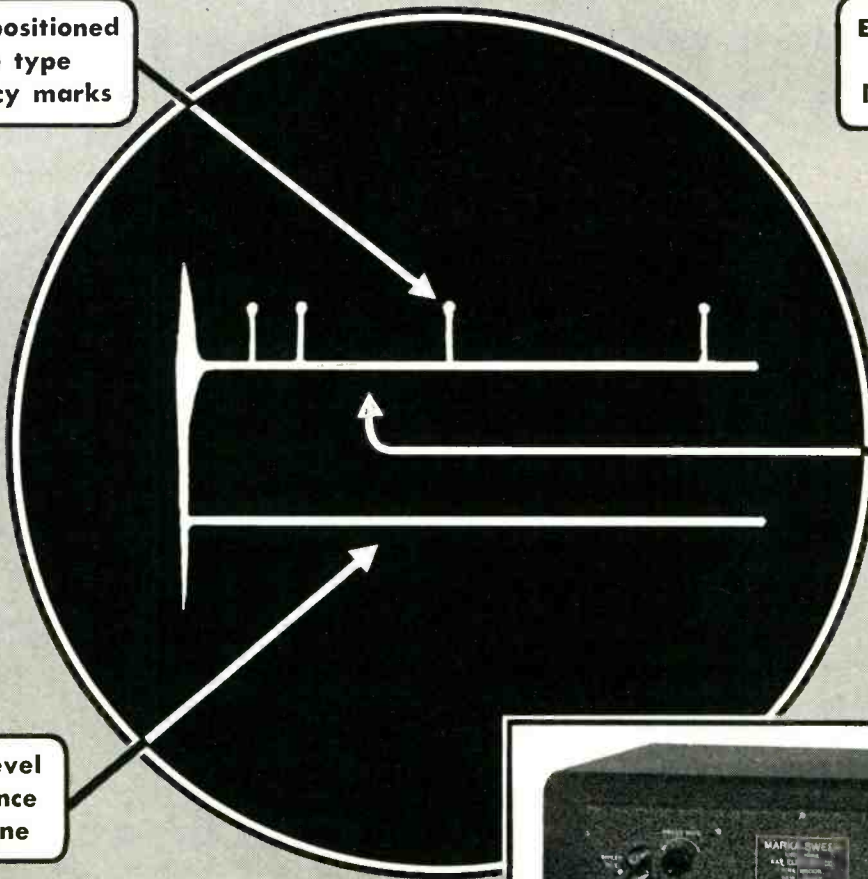

Zero level
reference
baseline



A New **SWEEPING OSCILLATOR DESIGNED FOR YOUR VIDEO NEEDS!**

The new Marka-Sweep Model Video extends to video circuit design and testing the speed, accuracy and convenience that has attended the use of sweep generators at higher frequencies. The oscilloscope pattern shown above is an exact reproduction of the detected output of the Model Video.

FEATURES:

Sweep Method: All Electronic

Sweep Ranges: 50 kc to 10 mc,
50 kc to 20 mcs.

Frequency marks of the pip type: Crystal positioned at 1, 2, 5, 10, 15, 20 mcs. Other frequencies to special order.

Variable frequency pip mark formed by injecting CW from auxiliary signal generator (Kay Accessory Oscillator now available.)

Separate attenuators on markers and video.

Price: \$495 f.o.b. Factory. 10% higher outside U.S.A. and Canada.

Write for Complete Specifications and 1951 Catalog



KAY ELECTRIC COMPANY

25 Maple Avenue

Phone CAldwell 6-4000

Pine Brook, New Jersey

GILBERT

...**FIRST** to investigate the
Phenomenon of Magnetism

Dr. William Gilbert

1544-1603

This great English physicist and physician to Queen Elizabeth is universally recognized as the "father of electricity." He first advanced the hypothesis that the earth itself is a great magnet, and confirmed his ideas by various magnetic experiments. The gilbert, C.G.S. unit of magnetomotive force, is named for him.

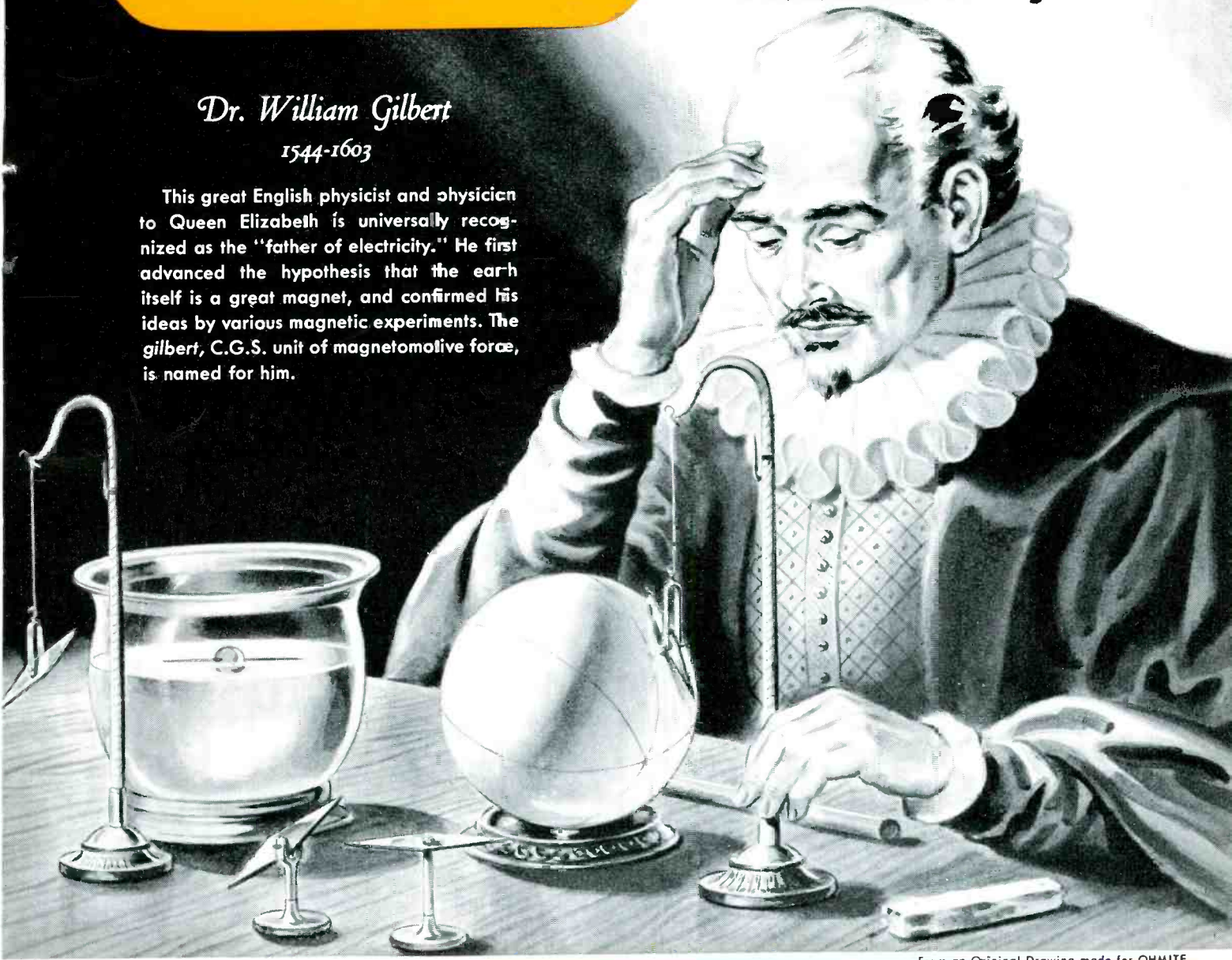

From an Original Drawing made for OHMITE

OHMITE

...**FIRST** in Rheostats

...Today

Be Right with

OHMITE
RHEOSTATS
RESISTORS
TAP SWITCHES



More manufacturers have standardized on Ohmite rheostats for their products . . . more companies are buying Ohmite rheostats for their own use . . . than any other make of rheostat on the market, today. The primary reason for this industry-wide preference for Ohmite rheostats is their proven dependability . . . their ability to give *extra* years of unflinching, trouble-free service.

OHMITE Rheostats...

Dependable

*because they're
built that way!*

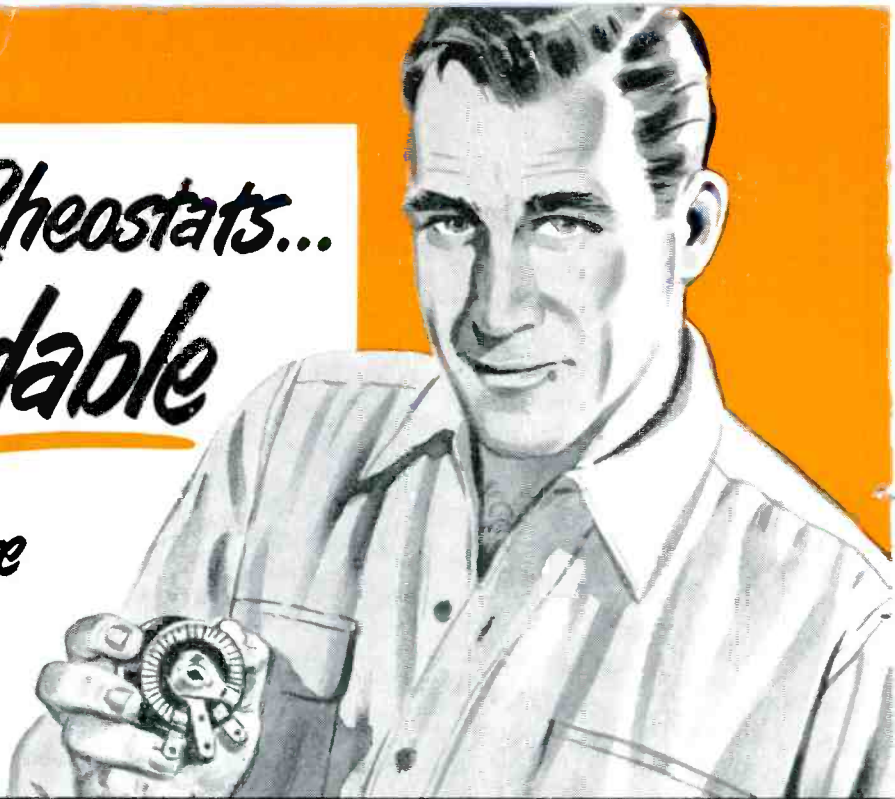

METAL-GRAPHITE BRUSH

Perfect contact with negligible wear on the wire is insured by the metal-graphite contact brush (varied to fit the current and resistance) and the large, flat contact surface.

LARGE PIGTAIL SHUNT

Current is carried directly to the slip-ring by a pigtail shunt of ample size, assuring an uninterrupted connection at all times. Large slip-ring minimizes mechanical wear.

INSULATED SHAFT

High strength ceramic hub insulates the shaft and bushing from all live parts. Underwriters' Laboratories listed models are available.

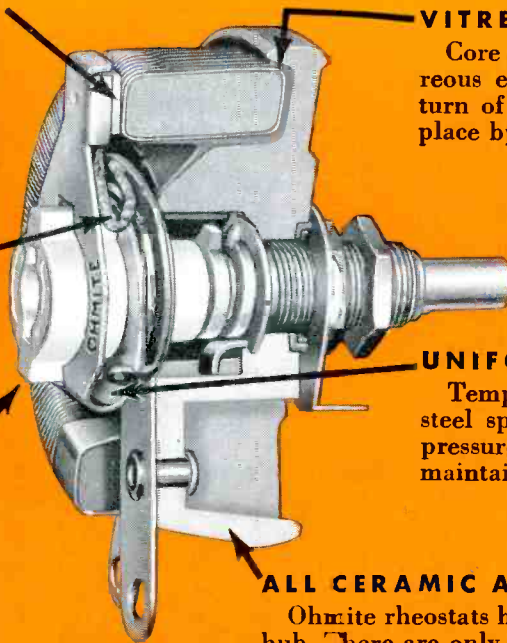

VITREOUS ENAMEL BOND

Core and base are bonded together by vitreous enamel into one integral unit. Each turn of wire is also permanently locked in place by vitreous enamel.

UNIFORM CONTACT PRESSURE

Tempered steel contact arm forms a long steel spring which assures uniform contact pressure. Universal joint action of the brush maintains "flush-floating" contact.

ALL CERAMIC AND METAL CONSTRUCTION

Ohmite rheostats have a ceramic core, base, and driving hub. There are only ceramic and metal in their construction—nothing to char, burn, shrink, or deteriorate. They are designed for long, trouble-free life.

OHMITE MANUFACTURING COMPANY

4816 Flournoy Street, Chicago 44, Illinois



WRITE on company letter-head for Catalog and Engineering Manual No. 40.



Be Right with...

OHMITE®

RHEOSTATS • RESISTORS

TAP SWITCHES



Instrument NEWS



Spoilage Costs Cut 90% With G-E Roughness Scales

Air Maze Company, Cleveland, Ohio, manufacturers of filters for all purposes say that their G-E surface roughness scales and specimens cut spoilage costs 90% which otherwise would have increased manufacturing expenses. "They have provided us with real savings in both time and money," says H. W. Matlock, chief draftsman for Air Maze.

Daily use is made of the roughness specimens in preparing the specifications and blueprints for component filter parts. Then, with the handy lightweight scales, Air Maze makes certain that the finishes on parts received from their vendors are correct. When there is a question as to the suitability of a standard part, they end the argument.

G-E surface roughness scales and specimens are particularly adaptable when any parts, manufactured by several sub-contractors or by different departments in one manufacturing plant, must have uniform surfaces roughness. The scales and specimens provide a common basis for the engineer, draftsman, machinist, and inspector in determining, supplying, and approving the correct surface finish.

Jet Engine Opposite-Polarity Ignition Coils are shown below being tested with a General Electric crest voltmeter. The crest voltmeter measures either positive or negative crest voltages. Portable—it does not need an external power supply.

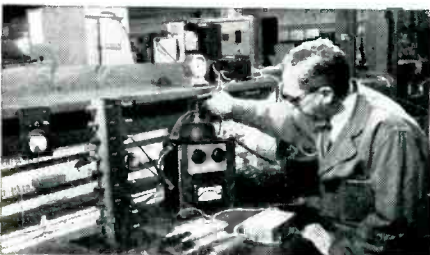

DINGS MAGNETIC SEPARATOR COMPANY RECOMMENDS USE OF G-E GAUSS METER



Dings Magnetic Separator Co., Milwaukee, Wis., manufacturer of magnetic separators, recommends the G-E gauss meter for determining the strength of the horseshoe magnets used in their separators. Reports Mr. Karl A. Blind, Chief Engineer at Dings, "We are recommending the G-E gauss meter to operating personnel in plants where magnetic separators are an essential part of production machinery. We believe operators should acquire and use the gauss meter for purposes of effectively and rapidly checking the full operating efficiency of the magnet."

Magnetic separators consist of either one or a series of permanent or electromagnets. Materials which contain mag-

netic foreign particles are passed in a steady flow near the magnets—which remove these foreign particles. This process sometimes requires much repetition, with the strength of the magnets varied each time. In order to do this, the exact strength of each magnet has to be controlled to within narrow limits. The General Electric gauss meter enables operators to maintain these limits.

Designed for unidirectional fluxes, the gauss meter can be used for checking flux densities and flux gradients in air gaps, and for measuring flux density in iron structures.

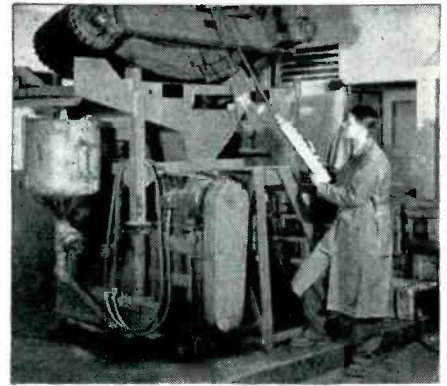

Ten Photoelectric Recorders Used at Battelle Institute



Battelle Institute, Columbus, Ohio, is now using ten General Electric photoelectric recorders in its industrial-research laboratory.

Some of the recent applications for which photoelectric recorders have been used at Battelle are: differential thermal analysis, and recording short-time high-temperature creep qualities of various

metallic and plastic substances. It is also used as a sensitive recording instrument for use in measurement and non-destructive testing where it responds to and signals from devices such as: ionization gages, photoelectric cells, thermocouples, transducers, and strain gages.

The Type CE photoelectric recorder measures d-c volts or amperes directly, and will record almost any quantity that can produce a d-c signal which varies in proportion to the quantity being measured. Chart speeds range from 1/2 inch per hour to 72 inches per minute; sensitivities are as high as 1.0 microampere full scale; response periods as fast as 1/5 second for full-scale deflection.

SECTION A 602-213, GENERAL ELECTRIC SCHENECTADY 5, N. Y.

Please send me the following bulletins:

Indicate:

- for reference only
- for planning an immediate project
- Gauss Meter (GEC-238A)
- Surface Specimens & Roughness Scales (GEC-774)
- Type CE Photoelectric Recorder (GEC-254)
- Crest Voltmeter (GEC-380)

NAME
 COMPANY
 STREET
 CITY ZONE STATE

GENERAL ELECTRIC

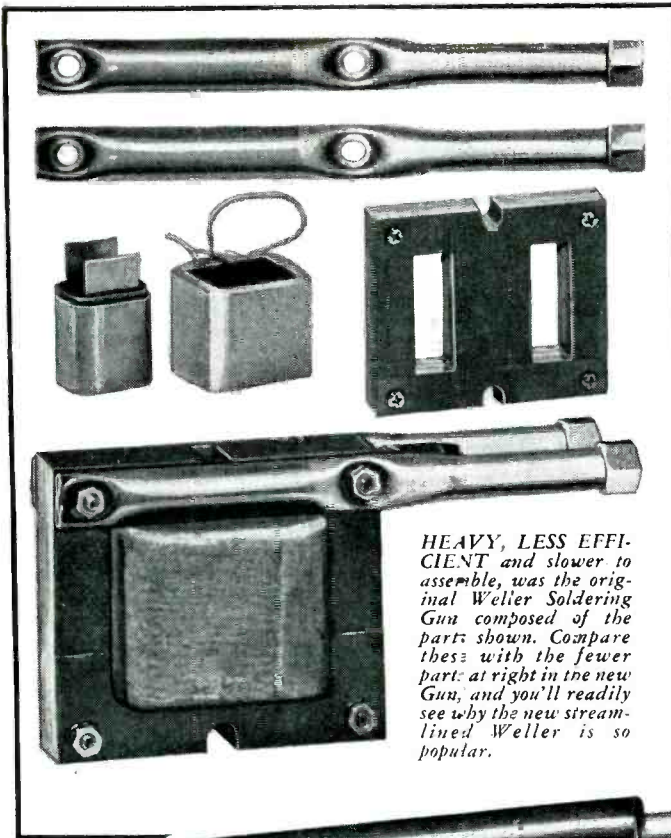

HEAVY, LESS EFFICIENT and slower to assemble, was the original Weller Soldering Gun composed of the parts shown. Compare these with the fewer parts at right in the new Gun, and you'll readily see why the new streamlined Weller is so popular.



THE NEW WELLER SOLDERING GUN handles 250 watts; heats, ready for use, in five seconds; has longer range to get into the tight spots, and is equipped with spot light. Uses current only when trigger is operated. It is assembled faster. Requires no bolts or nuts. The 3/8" Revere Copper Rod that replaces the secondary coil in the transformer is sheared, flattened, and bent at right angles in a 200-ton press in a single operation.



COPPER TREATS YOUR PRODUCT BETTER WHEN YOU

Control Your Temper

Revere Copper Rod replaces Secondary Coil in Soldering Gun Transformer . . . reduces number of parts, makes for a speedier, more efficient assembly . . . also makes possible a lighter, more compact unit of increased capacity.

WHEN the Weller Manufacturing Company, Easton, Pa., was completing the development of its new electric soldering gun, they were confronted with this problem: The 3/8" Revere Copper Rod used to replace the secondary coil in the transformer had to maintain its rigidity yet be sufficiently soft so that during the shearing, coining, and bending operations there would be no breaking or splitting of the rod.

Revere's Technical Advisory Service recommended a certain temper copper rod. It was discovered that Weller was getting a twist in the rod when it was installed in the assembled gun. Other tempers were tried

and tested. Then a copper rod of a slightly harder temper than the first was recommended. That was it! Proper temper was the key. Proper temper was also the key to the .291 dia. copper rod used for the Soldering tip itself. For this, too, had to retain its rigidity and yet remain soft enough to be coined, punched, and formed without fracture.

"In addition to being extremely helpful in arriving at the proper tempers, Revere also recommended that we specify our rod in multiple lengths, and thus save considerably on scrap. They were also helpful in solving the problem of attaching the brass sleeve to the secondary rod in

our Soldering Gun," the Weller Manufacturing Company tells us.

So you see, Revere's interest in your problem does not stop with the recommendation of its products. Perhaps Revere can help you. Why not take your current problem to the nearest Revere Sales Office and see?

REVERE

COPPER AND BRASS INCORPORATED

Founded by Paul Revere in 1801

230 Park Avenue, New York 17, New York

Mills: Baltimore, Md.; Chicago, Ill.; Detroit, Mich.; Los Angeles and Riverside, Calif.; New Bedford, Mass.; Rome, N. Y.

Sales Offices in Principal Cities, Distributors Everywhere.

The NEW Bogue Portable

400 CYCLE POWER SUPPLY

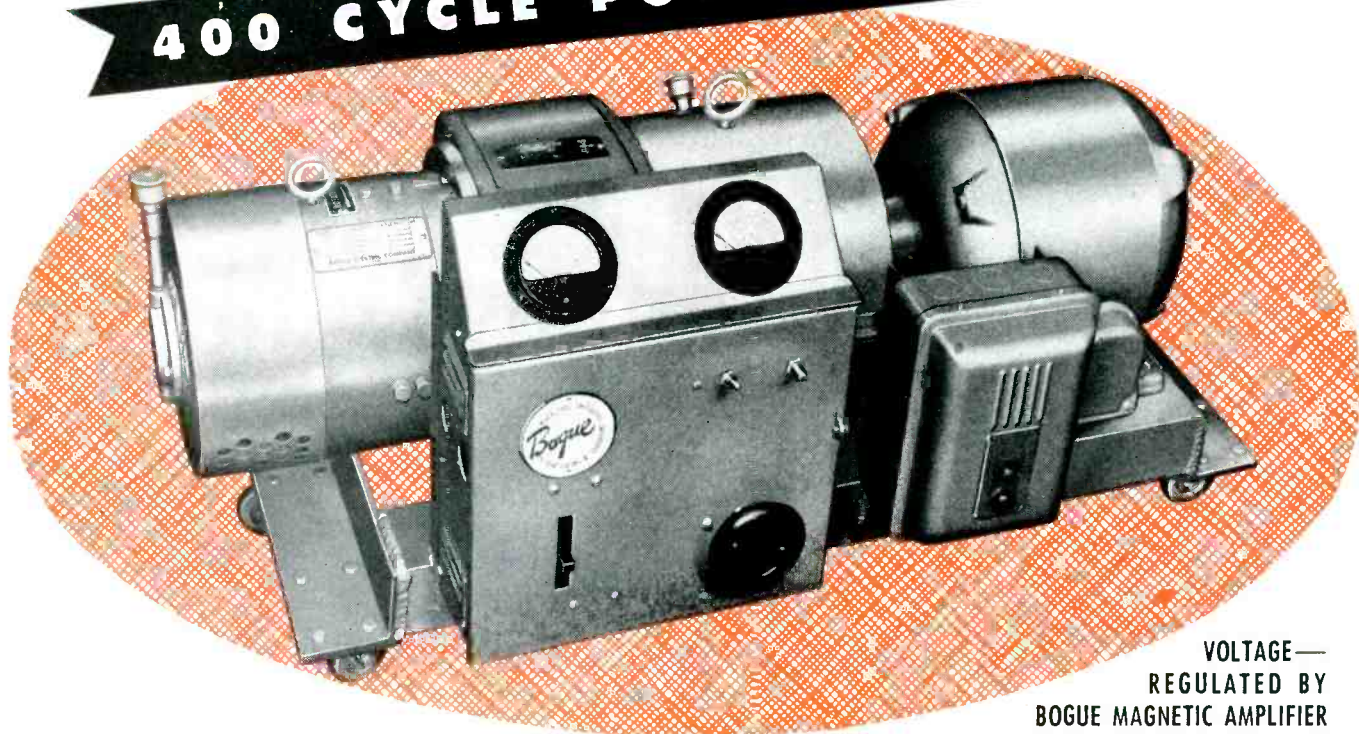

VOLTAGE—
REGULATED BY
BOGUE MAGNETIC AMPLIFIER

This compact completely self-contained motor generator set operates from commercial 60 cycle power to furnish up to 5 KW of 400 cycle power for use in testing 400 cycle radio and aircraft equipment as well as operation of high speed machine tools, etc. The unit is complete with starting equipment and automatic voltage regulator to maintain the output voltage constant

over varying loads. It can be supplied with either single phase or three phase 60 cycle motor and either single or three phase 400 cycle generator. The output wave form is extremely pure, the total harmonic content of the three phase design being approximately 1%. In order to move the unit from one location to another casters are supplied as standard equipment.

HOW BOGUE SERVES INDUSTRY

Bogue Electric specializes in producing electrical equipment required for special applications such as pure 400 cycle power . . . less than 1% harmonics; low ripple dc generators for precision testing of electronic equipment; magnetic amplifiers for reliable, constant speed and voltage control. Bogue electronic engineers have solved hundreds of confidential problems. They are always available to talk over your specialized control or power problems, too!

BOGUE ELECTRIC MANUFACTURING COMPANY

Where Precision Coordinated Design... Counts!

50 IOWA AVENUE

PATERSON 3, NEW JERSEY

MAGNETIC AMPLIFIERS • MAGNETIC CONTROLLERS • AC & DC MOTORS
AC & DC GENERATORS • VOLTAGE & SPEED REGULATORS • SWITCHBOARDS

SINCE 1892 SPECIALISTS IN
Bogue
FINE MOTORS & GENERATORS

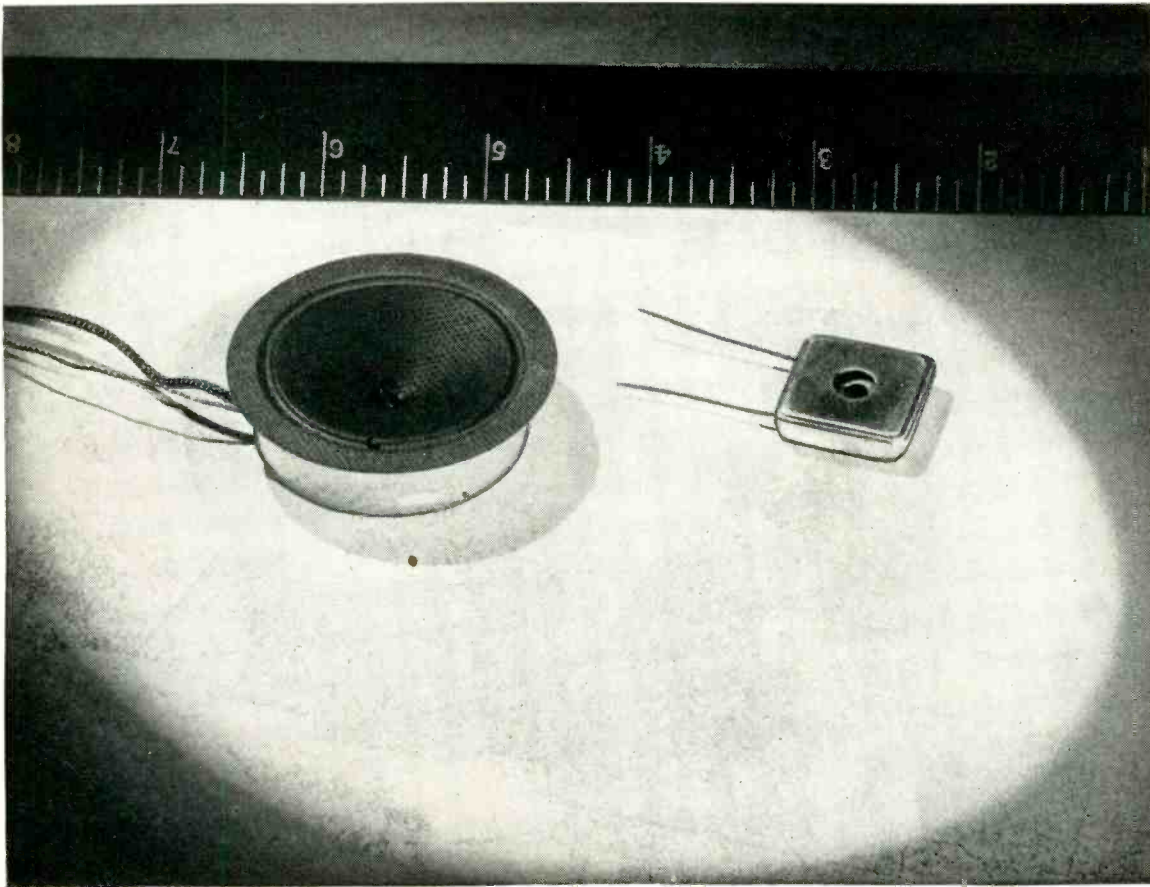

A *Brush* DEVELOPMENT

hearing aids have shrunk to half their size

• Brush has been the leader in cutting the size of hearing-aid microphones. Now hearing aids are small, almost unobservable and, most important of all, do their job better. Deaf people no longer have to wear bulky, unsightly and hard-to-operate hearing aids.

The Brush Development Company for more than 21 years has studied the intricate, though powerful, piezoelectric effects of crystals. The

principle of this smaller, more powerful microphone, as pioneered and developed by Brush, is that a tiny, jewel-like crystal converts sound waves into powerful electric signals. This is an example of continued engineering effort by Brush to make available to industry the many benefits and uses of piezoelectric materials, whether in hearing aids, measuring instruments or recording devices.

Manufacturers of

ACOUSTICAL EQUIPMENT

Microphones—General
Purpose and Specialized
Hearing Aid Microphones
Earphones—Of Many Types

MAGNETIC

RECORDING DEVICES

Tape
Plated Wire, Disc and Drum
Multichannel Recorders

Recording and Erase Heads
Memory Storage Units
Computer Components

RESEARCH AND INDUSTRIAL INSTRUMENTS

Universal Strain Analyzers
Surface Analyzers
Multichannel Direct Writing
Oscillographs

AC, DC and Carrier-type
Amplifiers
Uniformity Analyzers
Transient Recorders

PIEZOELECTRIC CRYSTALS

ULTRASONIC EQUIPMENT

Generators and Analyzers
Laboratory Equipment

OUR BUSINESS IS THE FUTURE

THE BRUSH DEVELOPMENT COMPANY

3405 Perkins Avenue • Cleveland 14, Ohio



SIGMA

Sensitive Relays

AVAILABLE SERVICE

1. Selection from six basic designs, each with many enclosure and mounting styles. Each such selection may be ordered with a coil resistance and adjustment chosen from a list of standard codes. The classification chart below, from the new catalog, calls attention to the most obvious points of comparison between design series.

2. Specification by our application engineers of the relay they would use if faced with your problem.* This includes selection of type and enclosure as well as design of special adjustment and electrical characteristics, all subject to your approval and test. The resulting specification is your property and will be disclosed only at your request.

*Don't fail to describe all of it, so as to reduce to a minimum our guesswork!

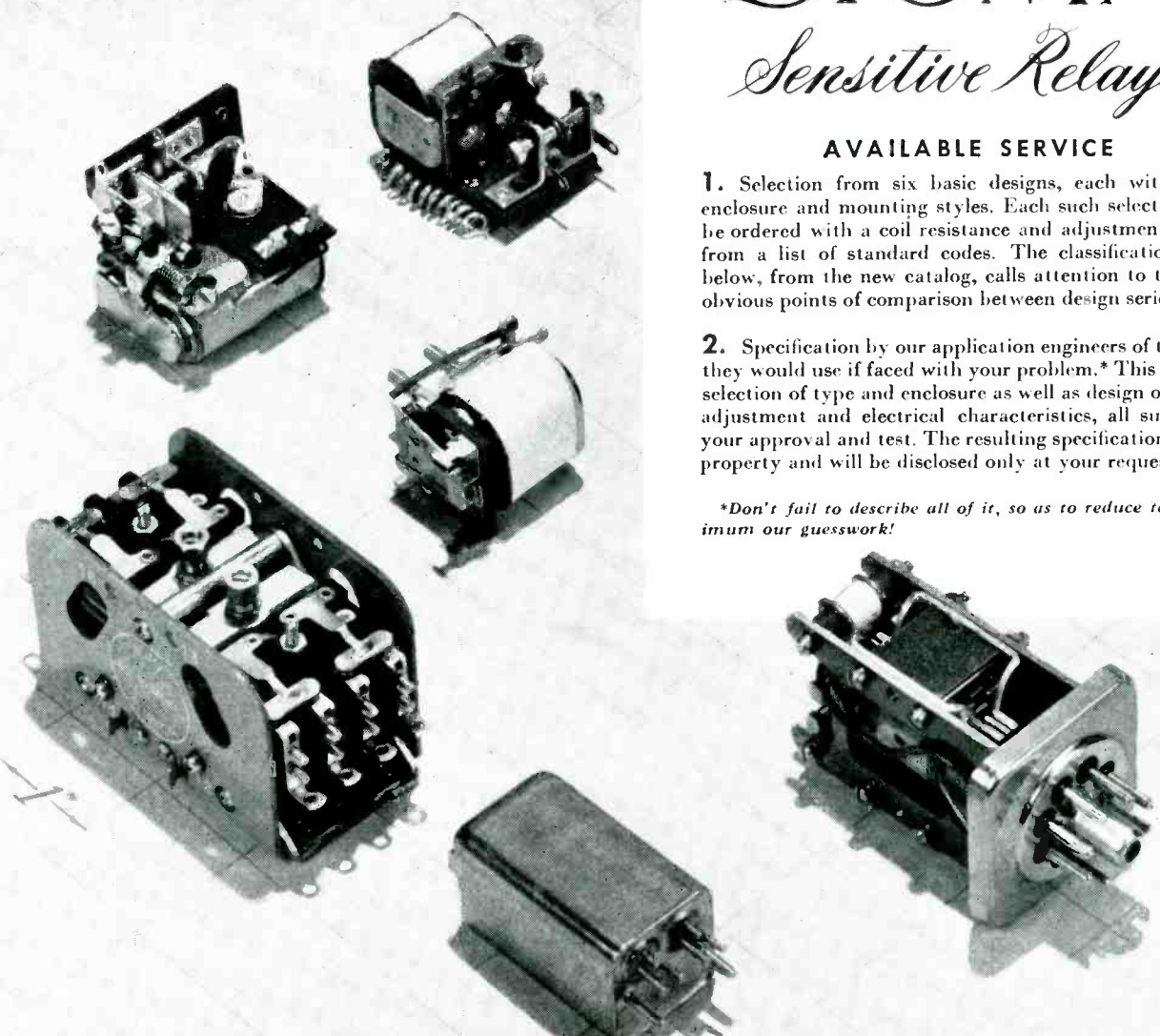

RELAY SERIES	SWITCH TYPE (MAX. CONTACT ARRANGEMENT)	SWITCH RATING*	SENSITIVITY		MAXIMUM COIL RESISTANCE OR IMPEDANCE	MAXIMUM COIL DISSIPATION (40° C rise)†	SPEED RANGE**	MOUNTINGS, ENCLOSURES, AND DESIGNATIONS			PARTICULAR FEATURES
			Maximum (Standard)	"Aircraft"‡				Open Frame	Dust Cover	Hermetic Seal	
4	SPDT (1-C)	2 amp.	.02 watt DC	.04 watt DC	12,000 ohms	1.5 watts 85° C	.002-.015 sec.	4F —	4A — 4R —	4RJ —	Medium price, sensitivity, and precision.
5	SPDT (1-C)	2 amp.	.001 watt DC	.010 watt DC	16,000 ohms	2.0 watts 100° C	.004-.090 sec. Slow release, with slug, available	5F —	5AH —	5RJ —	High sensitivity, shock resistance, stability, and vibration resistance.
			.007 watt AC, internal rectifier	.015 watt AC, internal rectifier					5R —	5JO —	
41	SPDT (1-C)	2 amp. (some styles 5 amp.)	.04 watt DC	Not generally recommended	12,000 ohms	1.5 watts 100° C	.002-.015 sec. Operates in 1st half cycle.	41F — (other open mountings available)	41R —	41RJ —	High AC sensitivity, long mechanical life; fast—good for pulsing; high load ratings; possible low price.
			0.1 VA AC 60 cps.	Not generally recommended	190,000 ohms	2.5 VA 100° C			41RO —	41JO —	
6	4PDT (4C)	2 amp. 5 amp. with SPDT DPDT	.05 watt — 4C contacts .012 watt — 1C contacts DC POLARIZED		25,000 ohms (12000/12000 in dual coils)	3.0 watts 85° C	.007-.05 sec.	6FX — 6FZ —	—	6HX — 6HY — 6HZ —	Polarized; biased, latching or 3-position (null-seeking). For relay-type and latching or pulsing, also switching and control functions.
7	SPDT (1-C)	2 amp.	.001 watt, switching, gen'l. .0001 watt, keying setting DC POLARIZED		12,000 ohms (3200/3200 in dual coils)	1.5 watts 85° C	.001-.007 sec.	—	7AOX — 7AOY — 7AOZ —	7JOX — 7JOY — 7JOZ —	Polarized; biased, latching, or 3-position (null-seeking). For relay-type and latching or pulsing, also switching and control functions.
22	DPDT (2-C)	2 amp.	.04 watt DC — 2C contacts .02 watt DC — 1C contacts		12,000 ohms	1.0 watts 100° C	.004-.090 sec.	—	—	22RJ —	Miniature double-pole; maximum shock resistance and precision.

* Nominal, 24VDC or 115VAC resistive; medium-duty life, eg. 100,000 operations.

** Approximate, as governed by normal variations in driving circuit.

† Any duty involving vibration up to 10g while in use.

‡ At operate voltage, operated. Unoperated, approx. 1/2 this value. Varies inversely with applied voltage.

§ Sum of ambient plus temperature rise not to exceed temperature given for each relay. Thermal time constant varies from 10 to 30 minutes. For higher temperatures, inquire of factory.



Write for fully descriptive catalog

SIGMA INSTRUMENTS, INC., 62 PEARL STREET, SOUTH BRAINTREE 85, MASS.

For low-level d-c measurements use these new, L&N triple-purpose Amplifiers

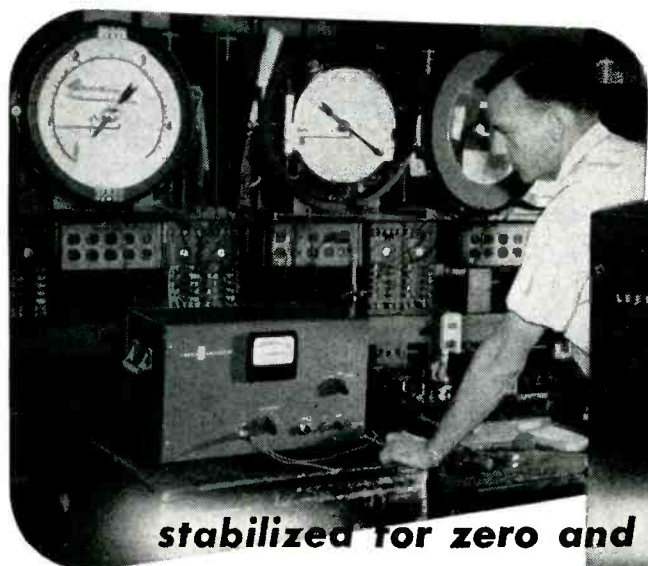

stabilized for zero and gain



High precision checking and calibrating under factory conditions using D-C Indicating Amplifier as null detector for accurate bridge and potentiometer circuits. Through combination of a-c amplification and balanced feedback network, zero and gain stability are designed right into instrument. Trimmer controls are eliminated.

can be used as . . .

- ✓ **DIRECT-READING MICROVOLT METER OR MICRO-MICROAMMETER**
- ✓ **RECORDER PREAMPLIFIER**
- ✓ **NULL DETECTOR**

SPECIFICATIONS

MICROVOLT UNIT
No. 9835

MICRO-MICRO-AMPERE UNIT
No. 9836

FULL SCALE RANGES WITH BUILT-IN 4" METERS

0 to 50 or -25 to +25 Microvolts; scale multipliers: 1, 2, 4, 10, 20, 40

0 to 1000 or -500 to +500 Micro - Microamps; scale multipliers: 1, 2, 5, 10, 20, 50, 100, 200, 500, 1000, 2000

ACCURACY

Of amplifier: $\pm 0.4\%$
Of reading; Of meter: $\pm 1\%$

Of amplifier: ± 0.5 to 0.8% * of reading;
Of meter: $\pm 1\%$

ZERO OFFSET

Max. offset: ± 0.5 Microvolt

Max. offset: $\pm 2\%$ of scale

*SOURCE RESISTANCE

Up to 10,000 ohms.

0.1 megohm or more.

REPOSE TIME

2 to 3* sec.

2 to 3* sec.

OUTPUT

For full scale input on any range: 10 millivolts at output impedance of 500 ohms for null recorder; 1 volt for 20,000-ohm external meter.

Front panel fits standard 19" relay rack.

*Accuracy and Response Time depend on Source Resistance.

THESE new D-C Indicating Amplifiers are the answer for all your low-level measurements with thermocouples, strain gages, bolometers—bridge and potentiometer circuits—ionization, leakage, and phototube currents—almost any measurement of extremely small direct current or voltage.

Actually 3 instruments in 1, Amplifiers can be used as:

✓ Direct-reading instruments—Scale multiplier knob lets you select the range in which you want to work.

✓ Recorder preamplifiers—with broad flexibility. One or two degrees temperature difference can be spread right across a 10" Speedomax recorder chart.

✓ Null detectors—more sensitive than most reflecting galvanometers, yet with full scale response time of only 2 to 3 seconds. Leveling is unnecessary; the instrument is not affected by vibration. At the turn of a range knob, you have available a wide choice of sensitivities. And when using non-linear response, not only does the instrument stay on scale at extreme unbalance; sensitivity increases automatically as the null point is approached.

For details, send for Folder EM9-51(1). Write our nearest office, or 4979 Stenton Ave., Phila. 44, Pa.



MEASURING INSTRUMENTS · TELEMETERS · AUTOMATIC CONTROLS · HEAT-TREATING FURNACES

LEEDS & NORTHROP CO.

Burnell *NOW* BIGGER THAN EVER IN THE PRODUCTION OF TOROIDS AND FILTERS

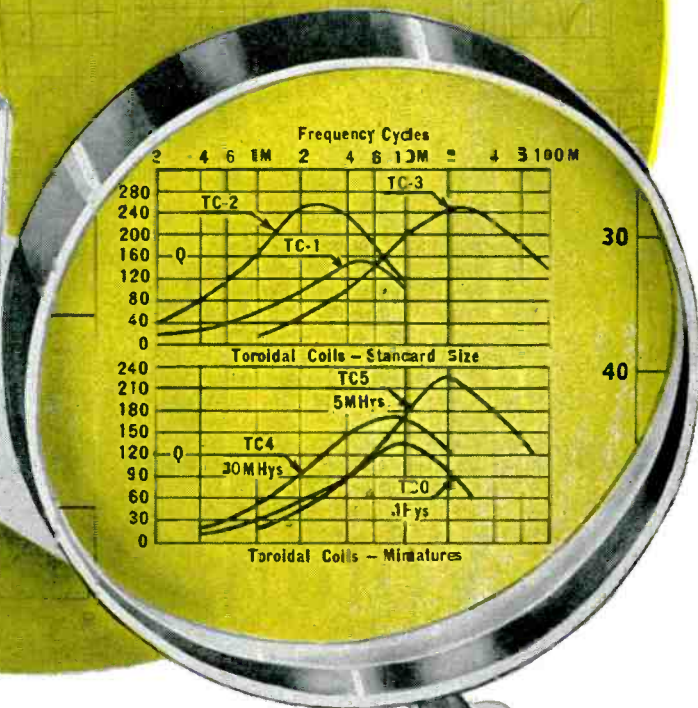
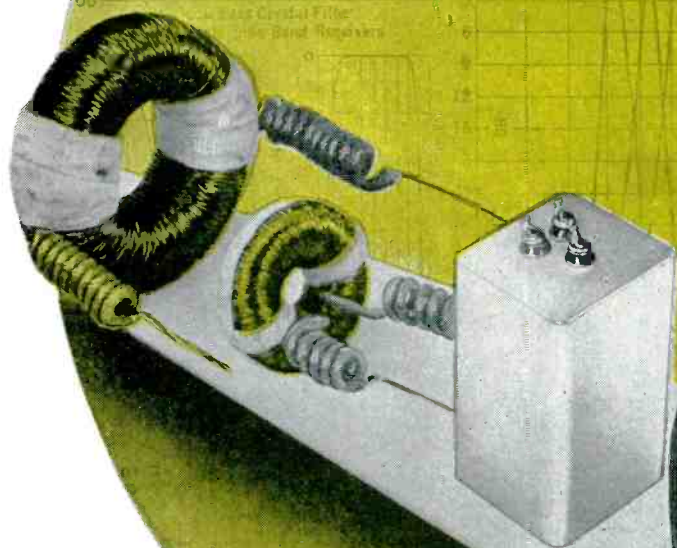

TYPICAL "Q" CHARACTERISTICS OF BURNELL TOROIDS WOUND ON MOLYBDENUM PERMALLOY CORES

Several years ago we began to specialize in the design and manufacture of toroidal coils and audio filter networks. At that time too few electronic engineers were aware of the full value of toroids (particularly those wound on molybdenum permalloy dust cores) as very little publicity had ever been devoted to a product that was fast becoming one of the most vital in the development of modern communications and control equipment.

We believe that since then through our technical service and advertising methods we have helped thousands of engineers to understand and appreciate the toroid as an essential in network applications.

The resulting popularity and industry acceptance of our toroidal coils and filters have necessitated an expansion of our production facilities to ten times what they were five years ago and we are proud to point to this growth as an expression from our customers of their satisfaction in the quality of our product and our service.

STANDARD SIZES	
TC-1	= 1 5/8" O.D. x 3/8"
TC-2	= 2 1/4" O.D. x 3/8"
TC-3	= 1 1/2" O.D. x 9/16"
MINIATURE SIZES	
TC-0	= 3/8" O.D. x 3/8"
TC-4	= 1-3/16" O.D. x 9/16"
TC-5	= 1-3/16" O.D. x 9/16"
MAXIMUM INDUCTANCE	
TC-1	— Ind. Up to 10 Hys.
TC-2	— Ind. Up to 100 Hys.
TC-3	— Ind. MHY-Up to 750
TC-0	— Ind. Up to 2 Hys.
TC-4	— Ind. Up to 10 Hys.
TC-5	— Ind. MHY-Up to 750

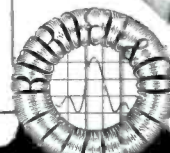

Burnell & Company
YONKERS 2, NEW YORK

CABLE ADDRESS "BURNELL"

EXCLUSIVE MANUFACTURERS OF COMMUNICATIONS NETWORK COMPONENTS

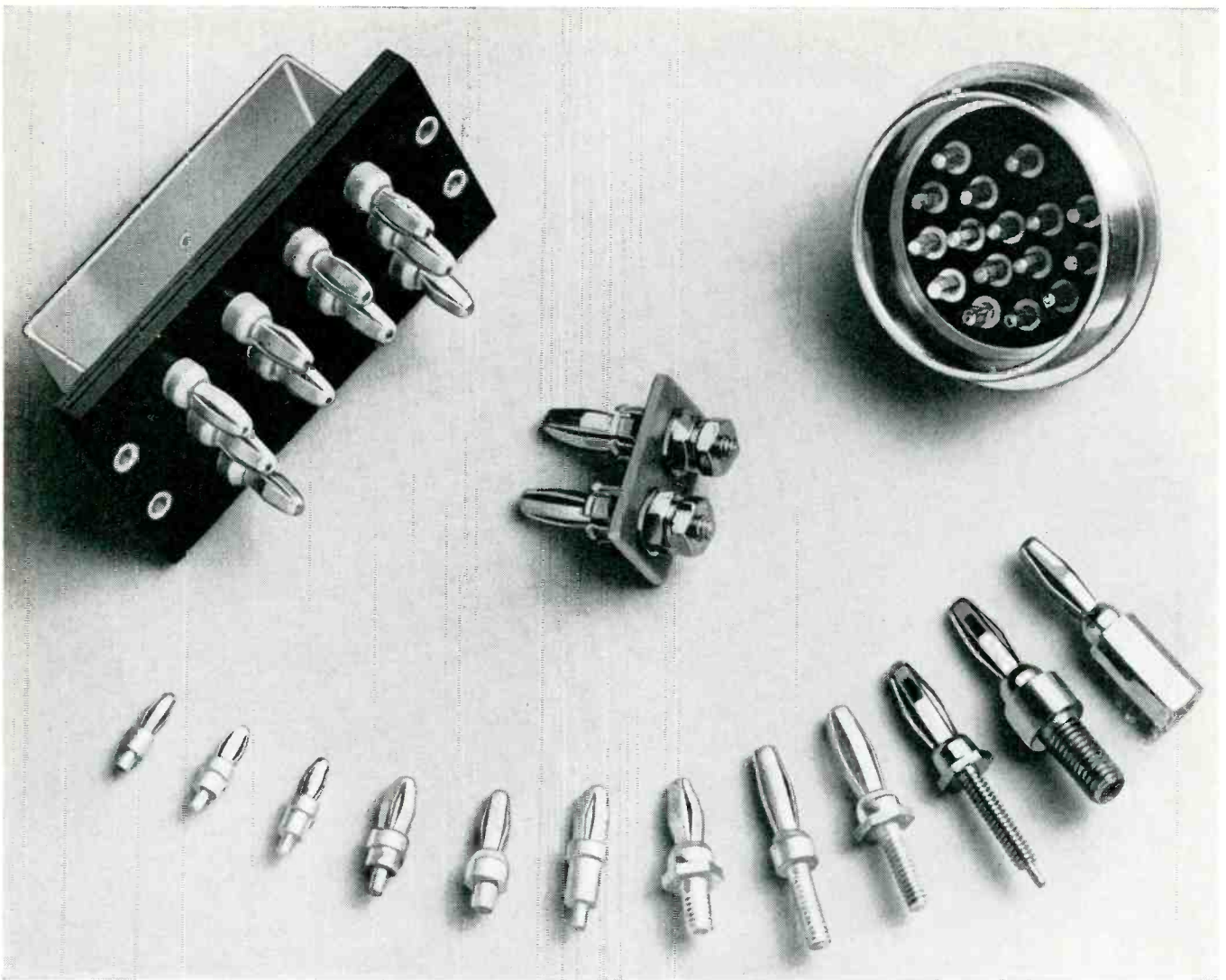

Volume and Variety

You can count on Banana Pins to keep contact in mobile connections, even under conditions of extreme vibration. They come in a wide range of shapes and sizes, and are easily adapted to special assemblies. Here at Ucinite, we have the plant capacity to manufacture standard types in volume and are capable of engineering special types as required. We are also set up to turn out complete banana pin assemblies to your specifications.

Ucinite, with a wealth of experience in the development and production of electric components and assemblies, stands ready as before to supply parts promptly to manufacturers engaged in the present expanding defense production program.

The UCINITE CO.

Newtonville 60, Mass.

Divisior. of United-Carr Fastener Corp.

Specialists in
ELECTRICAL ASSEMBLIES,
RADIO AND AUTOMOTIVE

*R*adios are different now—



...and in this era of engineering progress
MODERN ELECTRONICS LOOK TO HI-Q*
 Capacitors • Trimmers • Choke Coils • Wire Wound Resistors

● No science has grown faster or gone farther than electronics since those first amazing crystal receivers picked words and music out of the air. And in the development of modern radio, TV, communications and other electronic equipment, one of the prime contributions to dependability, long life and compactness has come from the use of ceramic components as perfected by **Hi-Q**.

Though **Hi-Q** output in four plants is now at the rate of several million units a month, there is no variation in the quality or high performance characteristics of its capacitors, trimmers, choke coils and wire wound resistors. Engineering watchfulness and rigid production control insure the maintenance of uniform precision standards well within the limits of minute tolerances. And it has become an industry maxim that in the development of special components to meet unusual requirements, **Hi-Q** engineers are the most competent and resourceful in their field. Their services are available to your organization in helping solve any problems you may have.

JOBBERS — ADDRESS: 740 Belleville Ave., New Bedford, Mass.

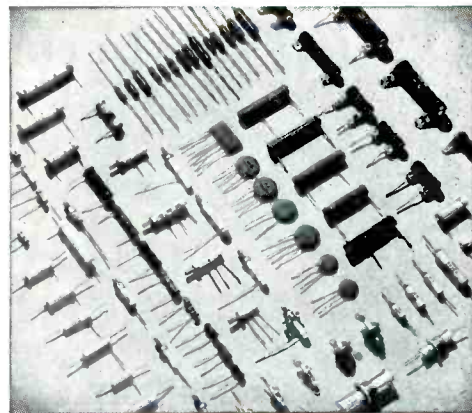

BETTER 4 WAYS

- ✓ **PRECISION**
- ✓ **UNIFORMITY**
- ✓ **DEPENDABILITY**
- ✓ **MINIATURIZATION**

* Trade Mark Registered, U. S. Patent Office



Electrical Reactance Corp.
 OLEAN, N. Y.

SALES OFFICES: New York, Philadelphia, Detroit, Chicago, Los Angeles

PLANTS: Olean, N. Y., Franklinville, N. Y. Jessup, Pa., Myrtle Beach, S. C.

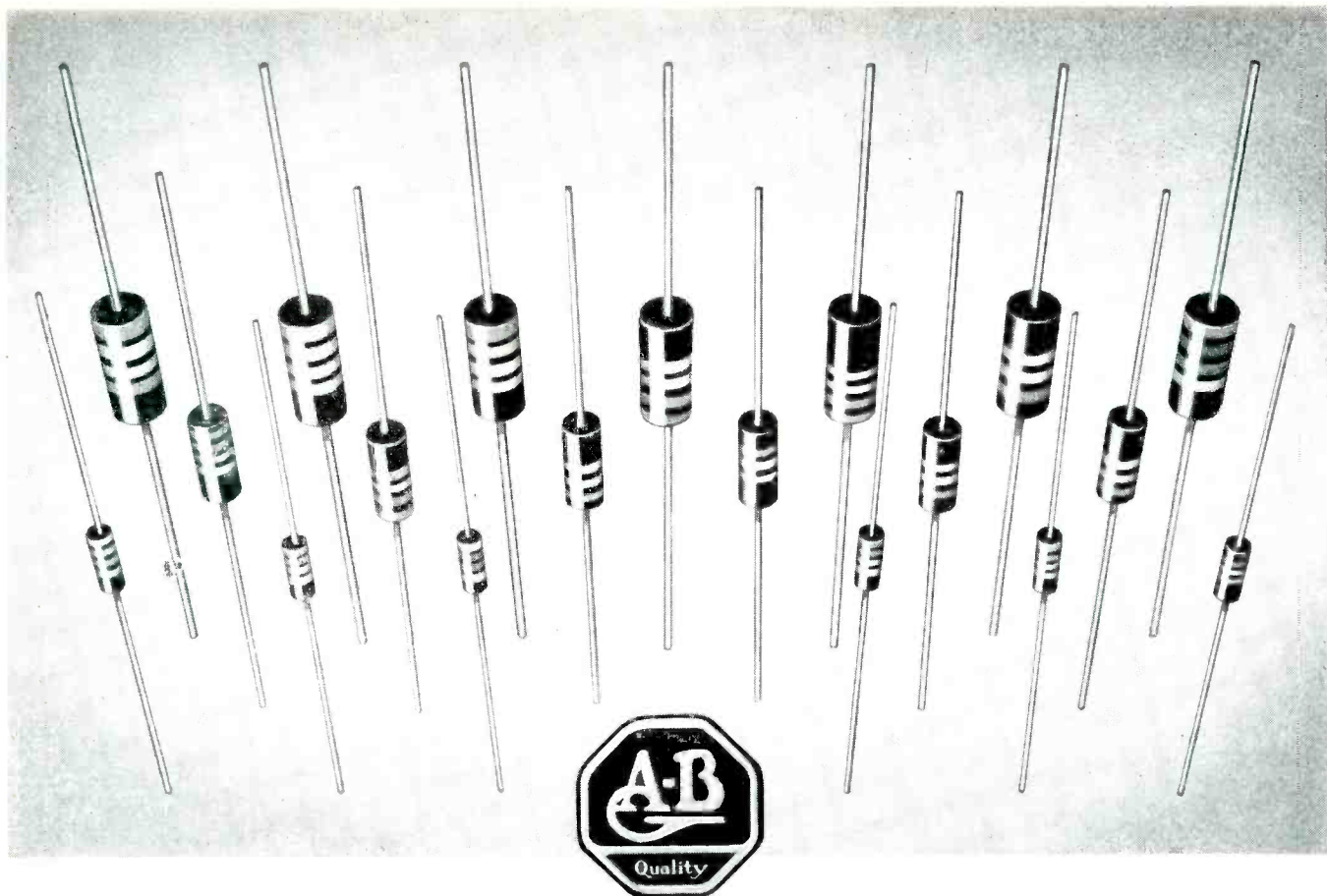

FIXED RESISTORS THAT STAY FIXED . . . because they are rated at 70C



Differentially tempered leads

The leads of all Bradleyunits are differentially tempered. This graduated softness of leads near the body of the resistor prevents sharp bends and avoids damage to resistor.

SIZES OF UNITS

Rating	L	D
$\frac{1}{2}$ -w	3, 8"	9/64"
1-w	9, 16"	7/32"
2-w	11/16"	5/16"

Bradleyunits have a wide safety factor. They are not crowded for performance because they are rated at 70C . . . not at the usual 40C.

Another thing . . . under continuous full load for 1000 hours, the resistance change is less than 5 per cent. They withstand all extremes of temperature, pressure, and humidity. And, don't forget that Bradleyunits require no wax impregnation to pass salt water immersion tests.

Bradleyunits are packed in honeycomb cartons to keep the leads straight and to avoid tangling during assembly operations. They are available in $\frac{1}{2}$, 1, and 2-watt ratings in standard R.T.M.A. values up to 22 megohms.

Allen-Bradley Co.

110 W. Greenfield Ave., Milwaukee 4, Wis.



ALLEN-BRADLEY

FIXED & ADJUSTABLE RADIO RESISTORS

Sold exclusively to manufacturers  **QUALITY**  of radio and electronic equipment

FOR EXTRA FAST STOPS

STARTS

REVERSES



**New TYPE R-24
process control motor**

Holtzer-Cabot Type R-24 motors are designed especially to provide the rapid starts, stops and reverses required by modern, high-speed process control equipment. Extremely low rotor inertia, *plus* high accelerating and decelerating torques, provide extremely quick response. Tests show that, with the dynamic braking connection, the unloaded rotor will *always stop within three-quarters of one revolution!* On geared motors, of course, this means that the output shaft stops in a very small fraction of a revolution.

These motors are 2-phase, squirrel-cage, nonsynchronous induction type. For operation on a single-phase circuit, a capacitor is used in series with one phase. Special high impedance windings are available, suitable for matching standard power tubes.

Available speeds, 1300 RPM (1800 synchronous speed) to $\frac{3}{4}$ RPM (geared), with torque ratings from 0.5 to 75 oz. in. Can be provided for odd voltages and frequencies, with ball or sleeve bearings. These motors are ideal for Servo-Mechanisms.



INVESTIGATE NOW . . . Holtzer-Cabot welcomes inquiries involving special motors

HOLTZER-CABOT

DIVISION OF NATIONAL PNEUMATIC CO., INC.

BOSTON 19, MASSACHUSETTS

"Manufacturers of fine electrical apparatus since 1875"

from

Quality Production

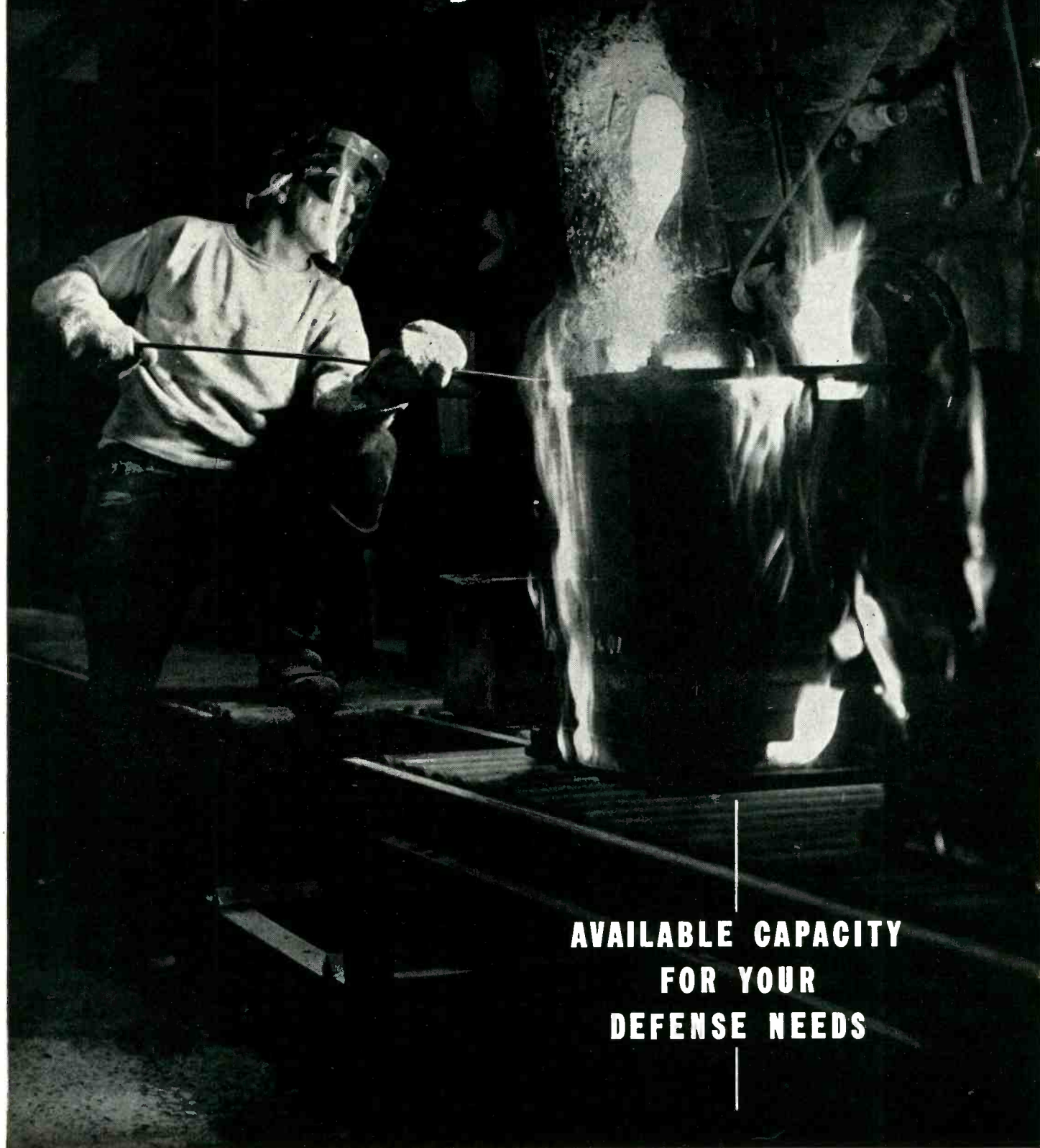

AVAILABLE CAPACITY
FOR YOUR
DEFENSE NEEDS

to Delivery on Schedule

Dependable

is
the
word
for



For over 22 years the Carboloy organization has led in *quality* and *uniformity* of man-made metals.

Carboloy Alnico Permanent Magnets are no exception. From the raw materials to finished permanent magnets, each stage of manufacture is subject to a rigid system of continuous quality control.

Quality checks and recordings, tests and retests are run to strict specifications by highly skilled personnel working with the latest equipment.

More, the same dependable control applies to *shipments*, too. Once your defense order is accepted and scheduled, delivery is made as promised.

Result: Carboloy Alnico Permanent Magnets of the *highest uniform quality* roll into your plant on the dot.

For information on the availability of Alnico Permanent Magnets, write today. Carboloy's engineering consultants and technicians will give immediate attention to your magnet problems.

CARBOLOY

DEPARTMENT OF GENERAL ELECTRIC COMPANY

11139 E. 8 Mile Road, Detroit 32, Michigan

CARBOLOY®

"Carboloy" is the trademark for the products of Carboloy Department of General Electric Company

ALNICO PERMANENT MAGNETS



WIRING KNOW-HOW



CONTINUING PROOF . . .

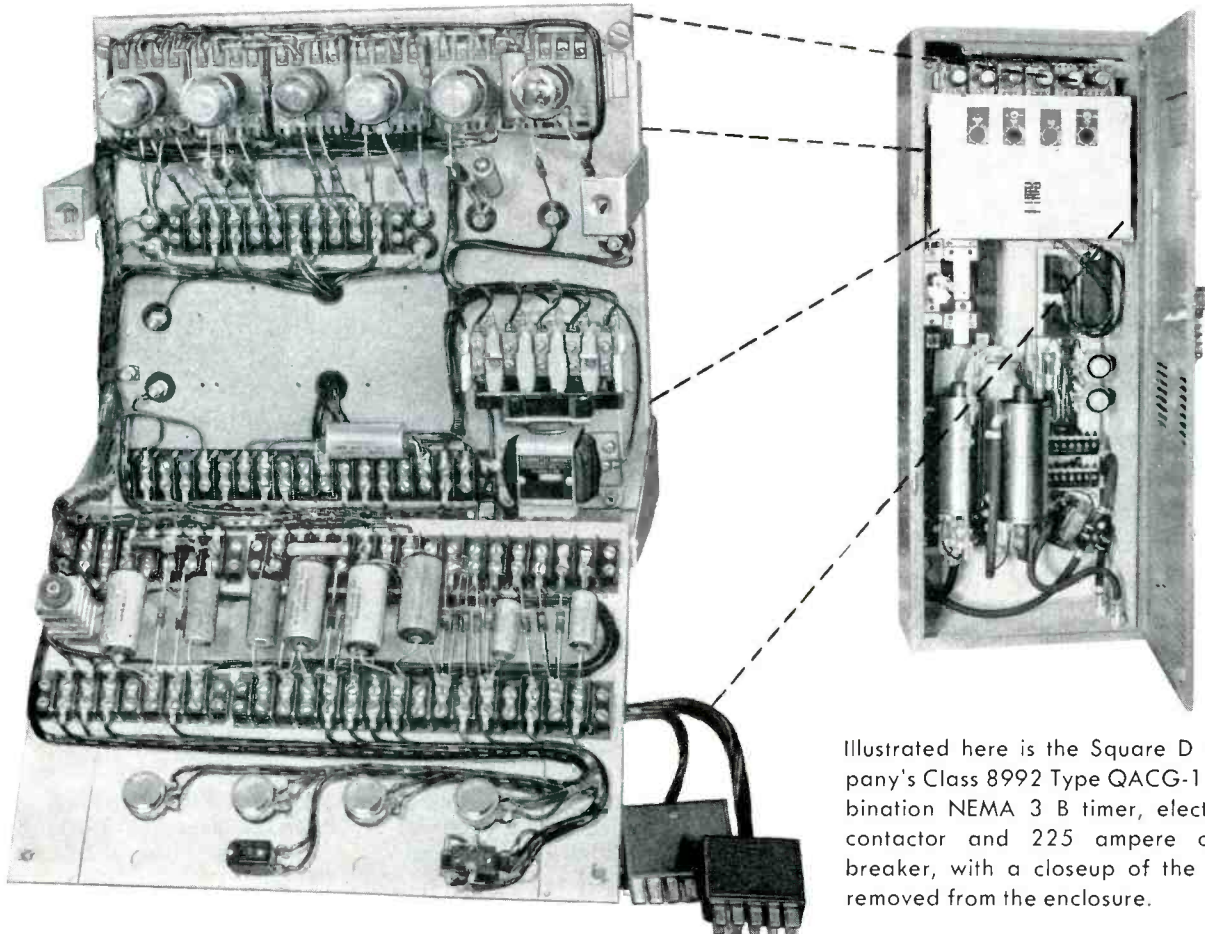

Illustrated here is the Square D Company's Class 8992 Type QACG-1 combination NEMA 3 B timer, electronic contactor and 225 ampere circuit breaker, with a closeup of the timer removed from the enclosure.

UNILECTRIC WIRING REDUCES COST ON SQUARE D COMPANY ELECTRONIC WELDER CONTROLS

Meticulous workmanship is vital in the UNILECTRIC Wiring System installed in this timer for the Square D Company's Electronic Welder Control. In addition, this application has resulted in reported savings up to 20% for the Square D Company, plus savings in installation time and inspection.

UNILECTRIC'S eight years of experience in producing intricate electronic and electric wiring systems — harnesses, cable assemblies, leads and cords — assures both electrical integrity and cost reduction in the wiring of Defense and Civilian electrical equipment.

UNILECTRIC Wiring Systems have

served RADAR, RADIO, FIRE CONTROL INSTRUMENTS, TANKS, TRUCKS, MOTORCYCLES, and many other vital wartime products, as well as millions of electrical appliances and industrial applications. More than 200 manufacturers — like SQUARE D COMPANY — depend on UNILECTRIC for reliable product wiring at lower cost. UNILECTRIC can help YOU. It costs you nothing to prove it. Write or wire.



Manufactured by
UNITED MANUFACTURING & SERVICE COMPANY
415 SOUTH 6th STREET • MILWAUKEE 4, WISCONSIN

this is it!



UP

The TL-10 in raised position allows discs to be played



DOWN

The TL-10 mounted and ready for perfect tape reproduction

new PRESTO Turntable Tape Reproducer

When we introduced the PRESTO TL-10 at the IRE, NARTB and Parts Show this spring we knew it was good—and we knew that there was a place for it in the nation's stations, recording studios and schools.

But we never realized just *how* popular it would be. This inexpensive turntable tape reproducer has turned into the sensation of the industry—and here are a few of the reasons why!

- Easy to attach to and remove from any standard 16" turntable.
- No motor—turntable acts as motor.
- Can be plugged into any standard speech input equipment.
- Speeds of 7½" and 15" per second, response up to 15,000 cps.
- Low cost—but has reproduction quality and fidelity of a high priced machine.
- Easy to operate—and maintain.

If you haven't ordered your TL-10 already, do it today. Its addition to your studio will save you time ... space ... and money!

**PRESTO**
RECORDING CORPORATION
PARAMUS, NEW JERSEY

Export Division: 25 Warren Street, New York 7, N. Y.

Canadian Division: Walter P. Downs, Ltd., Dominion Square Bldg., Montreal

www.americanradiohistory.com

GREATER VALUE

WITH

BENDIX SCINFLEX ELECTRICAL CONNECTORS

PRESSURE TIGHT SOCKET CONTACTS

PLUS

- Moisture-proof
- Radio Quiet
- Single-piece Inserts
- Vibration-proof
- Light Weight
- High Insulation Resistance
- Easy Assembly and Disassembly
- Fewer Parts than any other Connector
- No additional solder required

Outstanding design and precision workmanship assure completely pressurized electrical connectors for all sizes of contacts. A truly important feature, but only one of the many exclusive advantages that contribute toward making Bendix outstanding in the electrical connector field. Increased resistance to flash over and creepage is made possible by the use of Scinflex dielectric material—an exclusive development of Bendix. In temperature extremes, from -67°F. to $+275^{\circ}\text{F.}$ performance is remarkable. Dielectric strength is never less than 300 volts per mil. Remember, for the greatest value in electrical connectors, it pays to specify Bendix. Our sales department will gladly furnish complete information on request.

PLUS

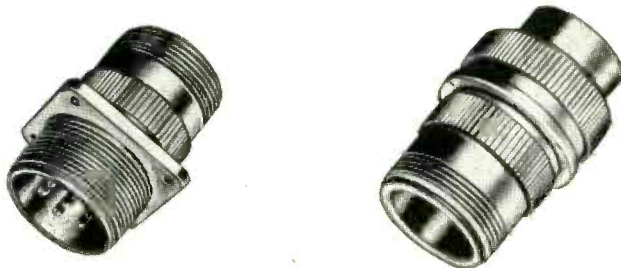
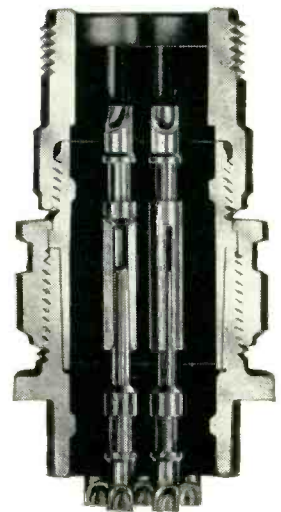

SHELL
High strength aluminum alloy
... High resistance to corrosion ... with surface finish.

CONTACTS
High current capacity ... Low voltage drop.

SCINFLEX ONE-PIECE INSERT
High dielectric strength ... High insulation resistance.

**SCINTILLA MAGNETO DIVISION of
SIDNEY, NEW YORK**

Export Sales: Bendix International Division, 72 Fifth Avenue, New York 11, N.Y.

FACTORY BRANCH OFFICES:

117 E. Providence Avenue, Burbank, California • Stephenson Building, 6560 Cass Avenue, Detroit 2, Michigan
Brower Building, 176 W. Wisconsin Avenue, Milwaukee, Wisconsin • 5282 Market Street, San Francisco 4, California



We Mobilize for Freedom

CONTROLS . . .

A Two-Edged Sword

It may seem dangerously premature to talk about getting rid of emergency government controls while all-out war is still an imminent possibility.

But success in this strange struggle for our freedom into which the Russian Communists have plunged us requires that we:

1. Maintain a whole battery of controls designed to speed defense production and curb inflation, and at the same time
2. Work to end the controls at the earliest possible moment.

Here is the reason why this editorial—fourth in a special series on mobilization for defense—is devoted to the need for a speedy release from controls.

If the Russian Communists can force us to maintain indefinitely the present system of government controls, they will have won a tremendous victory. They will have saddled us with a system of collectivism which, over a period of years, would be fairly certain death to freedom of business enterprise.

Make no mistake about it. This is not an argument against emergency controls. We need controls now to break a right of way for

our mobilization program through the business boom. Indeed, the third editorial in this special series was titled “Why Controls Are Necessary.” It stressed both the need for controls and the need for positive cooperation to make them work.

Controls Can Undermine Our Economy

But these controls surely chisel at the foundation of our normal economic system. So long as we have them, many if not most key business decisions will be made in Washington bureaus rather than in the free market place. For example, the *National Production Authority* administers a *Controlled Materials Plan* (italics ours) which directs the flow of basic metals, and decides who can use them for what purposes.

Happily, the people who operate these controls are not using the methods of a secret police state.

Even more happily, most of the leaders who have been drafted to manage the controls are not in love with their jobs. They are doing their best in the thankless task of making controls work. They recognize the danger of chronic controls.

But the fact remains that our economy is

operating under arrangements which carry it a long way toward the pattern of centralized control the Russians would inflict on the world.

The Wilson Plan

A plan for getting rid of these controls has already been developed. It was put together by our Director of Mobilization, Charles E. Wilson — while he was working day and night to set up the necessary emergency controls.

The Wilson Plan — if we escape all-out war — will strengthen our defenses and our economy. By 1953, it calls for:

1. Providing the weapons to equip an armed force of 3½ to 4 million, together with a supply of weapons for our allies.

2. Building a stockpile of weapons which, with current production, would be sufficient to carry on an all-out war for a year.

3. Building the manufacturing capacity by which we could rapidly expand our production of weapons if all-out war should come.

4. Increasing the productive capacity of industry enough to resume the expansion of our civilian economy.

With these jobs done our economy would be big enough and strong enough to meet both civilian and military requirements. And the government controls needed for mobilization could be speedily dropped.

Call for Sacrifice

The Wilson Plan requires a major effort — it means spending more than \$50 billion a year for mobilization. That is almost 20 percent of our total production. And this cannot be done without sacrifice. For a time, particularly in the next year, living standards will drop.

But the sacrifice required is amazingly small. At the peak of the defense effort, civilians will still have available to meet their needs about as much as they did in any year before 1948.

To make the Wilson Plan succeed we must curb inflation. A second year of inflation such as that which we have had since the Korean war started would multiply disastrously the costs of our defense program. One key part of a successful program to curb inflationary pressure, which soon will be building up again, is a pay-as-we-go tax program. The second editorial in this series urged that we do our utmost to pay as we go.

We Cannot Out-Control the Communists

But, above all, to make the Wilson Plan work we must keep our sights set on the crucial importance of increased production. Our problem is to increase our capacity to produce so that we can carry both a major military program and an expanding civilian economy for as many years — General Bradley thinks it might be fifteen or twenty — as the menace of Russian Communist aggression persists.

If we do not produce enough to do this double job, we shall be confronted with the prospect of having to live indefinitely under government controls of the sort that have been set up since the start of the Korean war. That would be delightful to the Russian Communists. It would go far toward making over our economy on the Moscow model.

Even if we wanted to, we never could hope to out-control the Russians. They are miles ahead of us in that line. But we can out-produce them, by a tremendous margin. By doing that we shall travel the surest road to victory.

McGraw-Hill Publishing Company, Inc.

It's a fact that

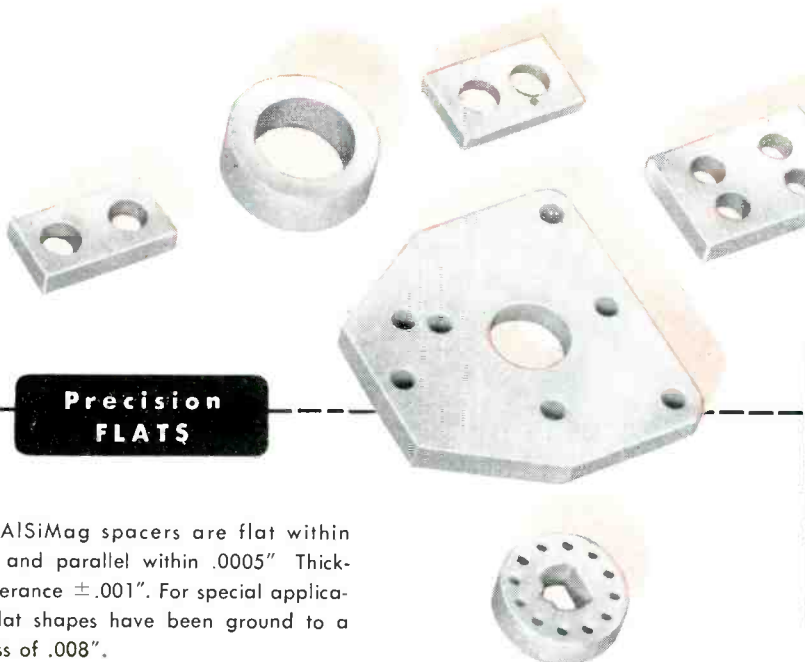

Precision FLATS

These AlSiMag spacers are flat within .0002" and parallel within .0005" Thickness tolerance $\pm .001$ ". For special applications, flat shapes have been ground to a thickness of .008".

Precision ROUNDS

These centerless ground AlSiMag shafts are held to diameter tolerances of $\pm .0002$ " and straight within .010, total indicator reading (.005 Camber), in lengths up to 9".

Our advanced grinding and lapping methods now permit dimensional accuracy formerly considered impossible in technical ceramics.

- ✓ We have advanced the technique of grinding AlSiMag ceramics so that we can obtain, on critical dimensions which lend themselves to grinding, the accuracy of comparable precision metal parts.
- ✓ Moreover, AlSiMag ceramics are more wear resistant than steel and, in many designs, can be manufactured to close tolerances at lower cost.
- ✓ Grinding is most practical on flat and round surfaces. We are equipped to grind flats up to 50 sq. in., rods up to 10" diameter and holes as small as 3/16"

ALSiMAG
TRADE MARK REG. U.S. PAT. OFF.

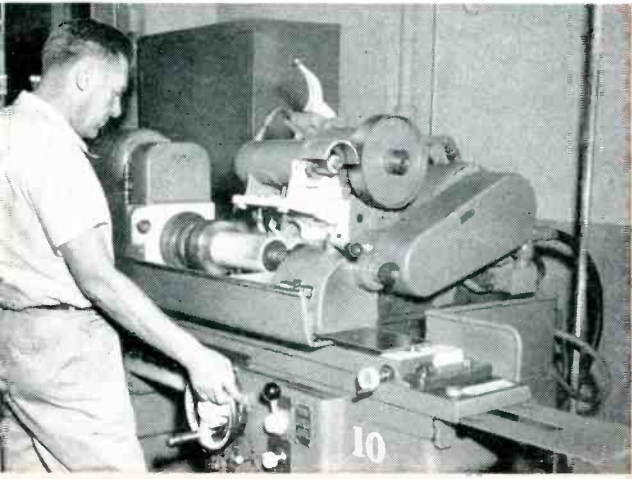

• If you have a design problem which might be solved by an AlSiMag technical ceramic made to close tolerances, send us your blue print and an outline of your requirements. Our comments and recommendations will be furnished promptly.

AMERICAN LAVA CORPORATION
50TH YEAR OF CERAMIC LEADERSHIP
CHATTANOOGA 5, TENNESSEE

OFFICES: METROPOLITAN AREA: 671 Broad St., Newark, N. J., Mitchell 2-8159 • CHICAGO, 228 North LaSalle St., Central 6-1721
PHILADELPHIA, 1649 North Broad St., Stevenson 4-2823 • LOS ANGELES, 232 South Hill St., Mutual 9076
NEW ENGLAND, 38-B Brattle St., Cambridge, Mass. Kirkland 7-4498 • ST. LOUIS, 1123 Washington Ave., Garfield 4959

for
design
engineer

AMP
MEETS ALL 3
REQUIREMENTS

production
engineer

government
and
industrial
approval

NOISE LEVEL TESTS

AMP

AIRCRAFT-MARINE PRODUCTS INC.
ELECTRONICS DIVISION
2100 PAXTON STREET, HARRISBURG, PA.

Canadian Representative: R. M. HUTCHESON, 10 Nordale Crescent, Hardington P. O., Toronto, Ont., Canada



New plus values—new designs
—new uses! AMP solderless pins,
plugs, hooks, contacts, and specially
shaped terminals do more than give
sound electrical contact—they can
be incorporated into the design of
the product itself! Keep AMP in
mind to simplify wiring, eliminate
unnecessary parts, speed
production, and reduce cost.

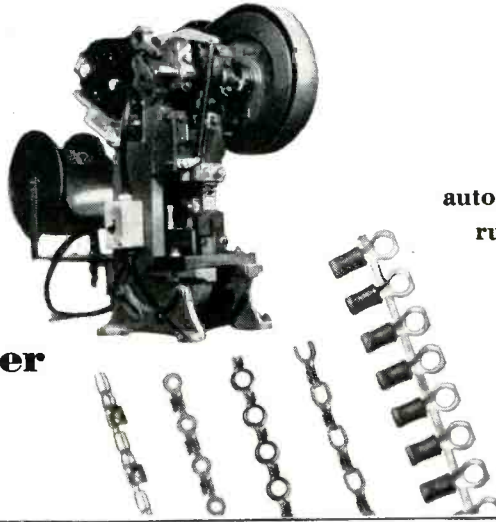

With wire termination it's
installed cost that counts. Set
up fast, efficient AMP
automatic machines for production
runs of 2,000 to 4,000 complete
terminations per hour!
Terminals feed in strip form
from spools. Each connection
is strong, neat, uniform.



AMP's superior design,
production, and performance
tolerances have yielded
approval for critical applications
by U. S. Army, Navy,
Air Force, and various civilian
agencies. List on request.

Recent tests on 14,000 AMP
solderless connections prove
that AMP terminals **WILL NOT**
PRODUCE NOISE even after
more than 2 years in
unfavorable atmospheres!

*AMP Trade-Mark Reg. U.S. Pat. Off.

a complete line of

Rectifiers

Small, lightweight a-c to d-c power supply units for use with cathode-ray tubes, television camera tubes and radar indicator scopes, electron microscopes, and similar jobs. Typical outputs are 7, 9 and 13 kv. Low regulation—the 7-kv unit illustrated does not exceed 3.5% regulation per 0.1 milliampere load, holds ripple on output voltage to less than 1%. Size, only 6" x 6" x 7", weight 8 lb.

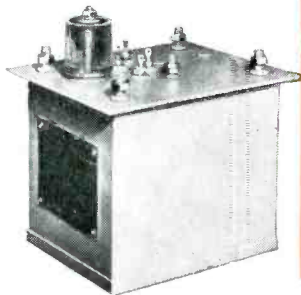

hermetically sealed oil-filled

HIGH-VOLTAGE COMPONENTS

Pulse Transformers

Pulse transformers for use with either hard-tube or line-type modulators. Available in voltage ratings of 10 kv or above. These units are ideal for radar applications, stepping up or down, impedance matching, phase reversing and plate-current measurements. Also suitable for nuclear physics research work, television and numerous special applications in and out of the communications fields.

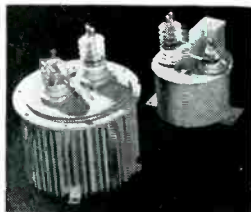

Resonant Reactors

Resonant-charging reactors, accurately designed and constructed for radar service. Usually required in ratings of 40 kv and below, 1 ampere and below and 300 henries and below. Higher ratings are being built, and can be considered. When required, small- and medium-size designs can be provided with 3 to 1 range of inductance adjustment.

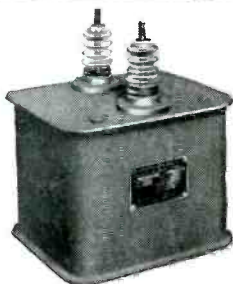

Filament Transformers

Filament transformers available with or without tube socket mounted integral with the high-voltage terminal. Low capacitance. Ratings to match any tubes; insulated to practically any required level.



Illustrated here are typical high-voltage components manufactured by General Electric. They can be built to meet Armed Services requirements. All are oil-filled and hermetically sealed—with excellent ability to withstand mechanical shocks and to operate continuously for long periods in widely varying temperatures. Apparatus Dept., General Electric Company, Schenectady, N. Y.

Your inquiries will receive prompt attention. Since these components are usually tailored to individual jobs, please include with your inquiry, functional requirements and any physical limitations. Write to Apparatus Dept., 42-328A, General Electric Co., Pittsfield, Mass.

GENERAL  ELECTRIC

401-63

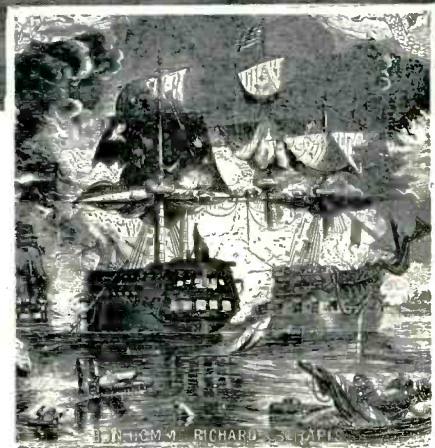
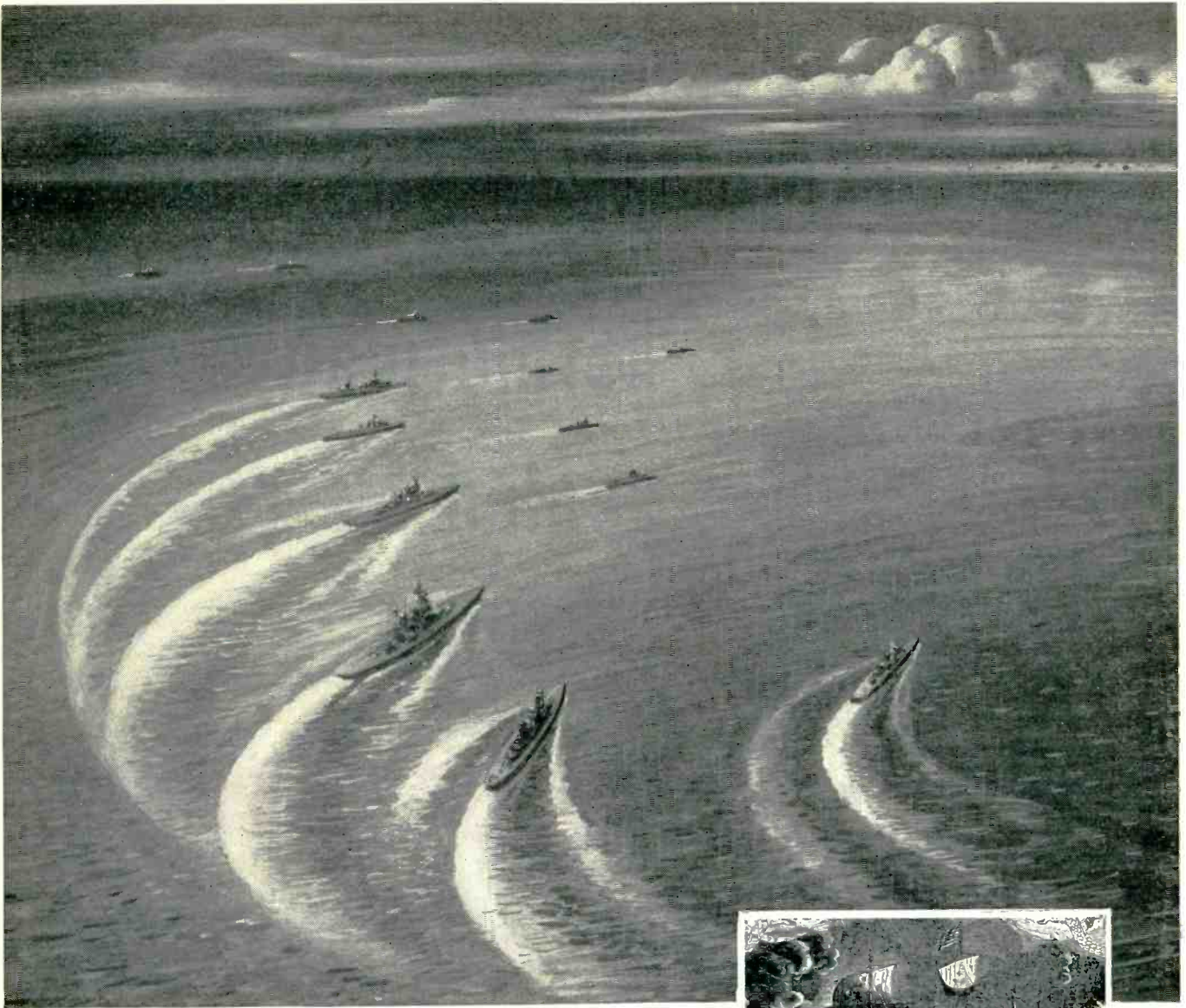

Bettmann Archive

“ON TARGET” TODAY

demands split-second mathematics

Today’s gunnery problems are a far cry from the days of slugging it out at close range. They demand instantaneous solutions to ever-increasing complex factors. Only continuing advance in elec-

tronic instrumentation can accomplish this feat. Through years of outstanding engineering design and precision manufacture, Arma leads in this vital supply link to our nation’s *Armed Forces*.



A R M A C O R P O R A T I O N
 254 36th STREET, BROOKLYN 32, N.Y.
 SUBSIDIARY OF AMERICAN BOSCH CORPORATION

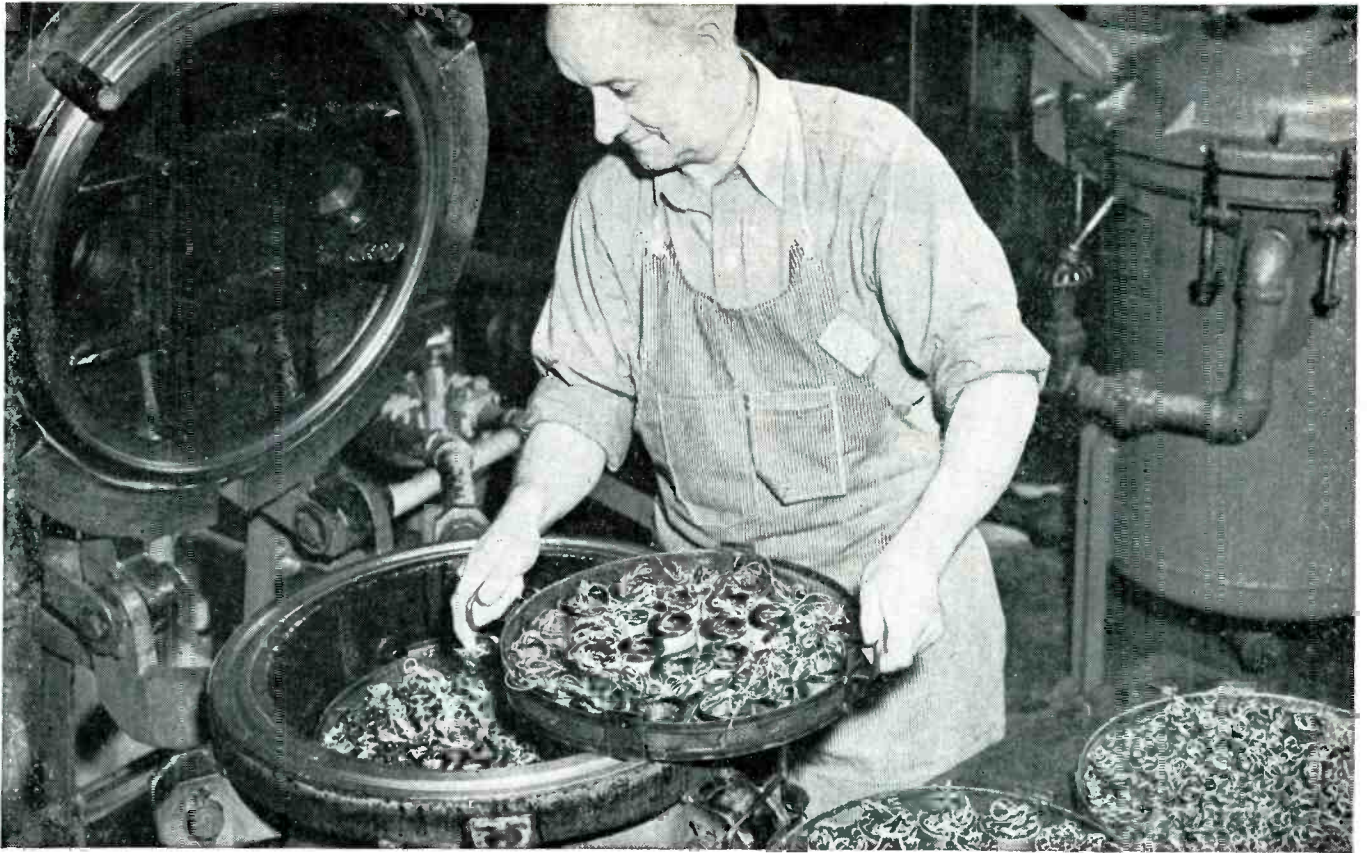

For *lasting* insulation strength, Sperry counts on **HARVEL 912-C**

For more than 10 years, Sperry Gyroscope Company has been insulating coils and other components with Harvel Internal Curing Varnishes, because of their excellent mechanical and electrical properties. Sperry . . . world famous for the quality and performance of its instruments . . . reports these specific advantages from the use of Harvel 912-C, electrical insulating varnish:

1. **High mechanical strength.** Conductors rigidly bonded into a compact mass. No soft, tacky varnish interiors to allow movement of conductors.
2. **High dielectric strength . . .** 2200 vpm. Electrical properties retained at high temperatures—unaffected by oil.
3. **Fast baking time.** 912-C cuts baking schedules as much as 50%—materially reduces production costs.

Sperry also turns to Irvington for Class "H" flexible insulations when space and weight are at a premium. Running safely at temperatures as high as 500°F, these insulations permit using smaller conductors, and thus open the way to lighter, more compact designs. It will pay you to investigate these Irvington products—mail coupon today for the full story.

Look to

IRVINGTON

for insulation leadership

INSULATING VARNISHES

VARNISHED LAMERIC

VARNISHED PAPER

VARNISHED FIBERGLAS

INSULATING TUBING

CLASS "H" INSULATION



Send this convenient coupon now

Irvington

VARNISH & INSULATOR COMPANY

Irvington 11, New Jersey

Irvington Varnish & Insulator Co.
6E Argyle Terrace, Irvington 11, N. J.

Gentlemen:

Please send me technical literature on:

Harvel 912-C Varnish Class "H" Insulation

Name.....

Company.....

Street.....

City..... Zone..... State.....

YOU CAN BE **SURE**.. IF IT'S
Westinghouse

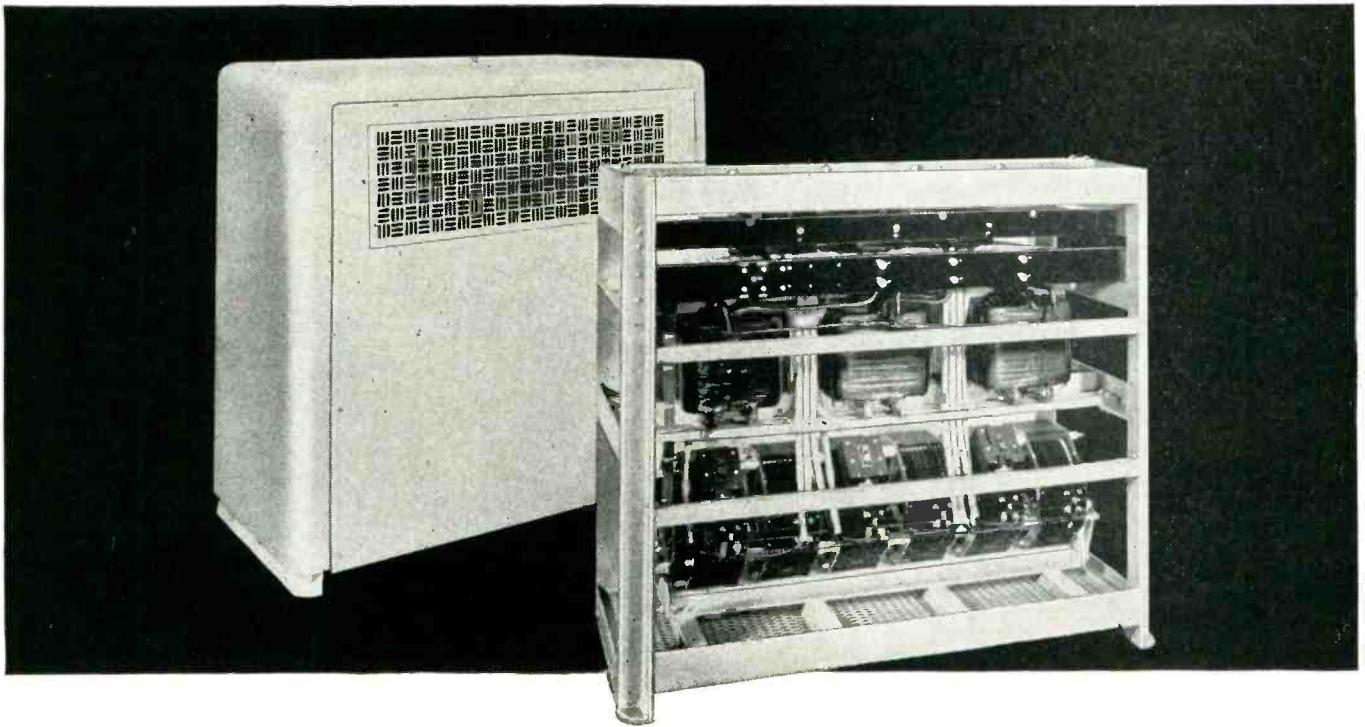

A Tough Transformer Problem Solved with **STEPLESS VOLTAGE CONTROL**

Here's a unique problem . . . but the solution illustrates the modern engineering available at Westinghouse to tackle all types of transformer problems.

The application: A transmitter required a d-c power supply of 4,000 volts, variable under full load . . . from plus 10% to minus 40%.

The Westinghouse solution: A combination of a three-phase, dry-type transformer to produce the required 4,000 volts, with a three-phase, buck-boost transformer, and a three-phase, motor-driven powerstat, serving a d-c rectifier. Quality-proven class B insulation and HIPERSIL® cores result in compact, lightweight installation that completely eliminates the need for bulky, oil-immersed, tap-changing equipment.

The main transformer is rated 73 kva, 230 volts delta on the primary, 4,240 volts wye on the secondary. The secondary of the buck-boost is in series with the output of the main transformer, and the powerstat acts to adjust the primary voltage on the buck-boost, so that stepless control of the entire assembly can be achieved under full load of the d-c rectifier. The operator stands in front of the transmitter itself, and raises or lowers the voltage by means of pushbuttons, while he watches the d-c plate voltmeter of the rectifier.

If you have a tough transformer problem, take advantage of the facilities of Westinghouse for quick, practical solutions. Transformers specially designed for all types of electrical and electronic circuits, as well as a wide selection of standardized designs . . . produced in quantity . . . with quality. Call your nearby Westinghouse representative, or write Westinghouse Electric Corp., P. O. Box 868, Pittsburgh 30, Pa. J-70565



Westinghouse

**SPECIALTY
TRANSFORMERS**



Master Pieces of Hermetic Sealing — Proven to Eliminate Rejects!

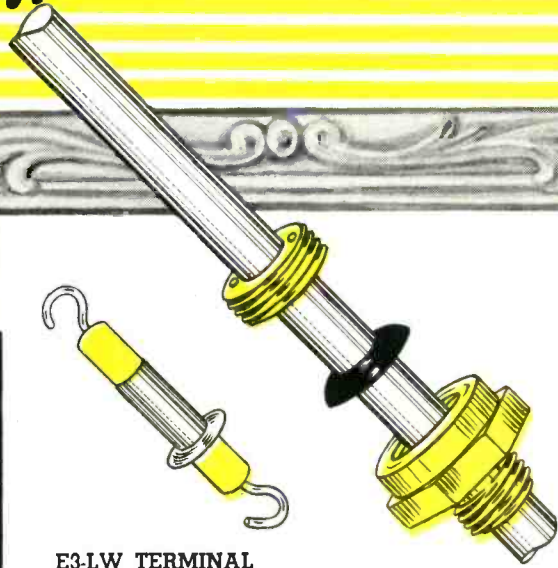

E3-LW TERMINAL

"E-Series terminals are applicable on MIL requirements and will withstand thermal shock, vibrations, mechanical strains, and excessive pressures with no impairment of the seal or other functional characteristics. E-3LW terminals are now being used at 1000 psi static oil pressure and undergo 5000 psi tests."

1/4" SHAFT WATERSEAL BUSHING

"Rotary Waterseal Panel Assemblies, with GRAF-SIL Packing Glands, have an excellent five year customer history on gas filled pressurized components. They are available for 1/4" shafts and for potentiometers and switch bushings."

PLUG IN TYPE HEADERS

OC-8
16 CHARACTERS
0.930 PIN
0.50 I.D.
0.40
FLASH OVER VOLTAGE
6000 V PIN TO RIM

OC-12
16 CHARACTERS
0.930 PIN
0.50 I.D.
0.40
6500 V PIN TO RIM

MULTIPLE TYPE HEADERS

1000 SERIES AVAILABLE WITH 2 TO 10 TERMINALS

2000 SERIES AVAILABLE WITH 2 TO 6 TERMINALS

**NEO-SIL HERMETIC SEALS
INDIVIDUAL TYPE TERMINALS**

E-1
FLASH OVER VOLTAGE
2500V

E-3
FLASH OVER VOLTAGE
5500V

E-4
FLASH OVER VOLTAGE
5500V

TEST DATA

The result of the Electrical Testing Laboratories Inc., Report #330655, dated March 18, 1949, on this material shows the following:

Volume Resistivity at 800 Volts d-c
Room Temperature 25°C R.H. 30 percent
Megohm-inches ohm-centimeters
 1.4×10^6 3.5×10^{12}

Dielectric Constant and Dissipation Factor

Dielectric Constant	Dissipation Factor	Loss Factor
9.22	@ 60 cycles per second .058	5.32
6.17	@ 1 megacycle per second .0455	.28
5.35	@ 50 megacycles per second 0.20	1.1

Dielectric Strength at 60 cycles
Volts per mil — 370

Durometer Average — 80 ± 5
Temperature — Rated as a Class A material conservatively $+105^\circ$ to -70° centigrade.

The Flashover Voltages indicated were taken at a temperature of 68° Fahrenheit, and 47% Relative Humidity.

"NEO-SIL's proven Hermetic sealing components will eliminate rejects resulting from breakage, strains, cracks, etc. Each NEO-SIL component is pressure checked at 25 psi — to meet military requirements and as applied to our units, NEO-SIL rubber will resist abusive temperature cycling, salt water, most acids and alkalis, and withstand high pressures and vacuums."

"In addition to the items illustrated above, NEO-SIL offers many other components, such as Hermetically Sealed Fuse Holders, Octal Type Plug In Headers, Multiple Pin Headers, Hermetically Sealed Cables, Hermetically Sealed Line Cords With Plugs For European use, Meter Gaskets, Panel Gaskets, Adapters (U.S. to Continental), Coil Forms, Crystal Contacts and other molded bakelite and NEO-SIL rubber units."

"Hermetically Sealed Fuse Holders are available for 3-AG and 4-AG fuses. These units are completely sealed from moisture with or without the cap or fuse inserted and are applicable for use on vacuum or gas filled units."

Your special problems are solicited.



26 CORNELISON AVE., JERSEY CITY 4, N. J.



QUALITY CONTROL



DESIGN ENGINEERING



PRODUCT ENGINEERING



GLASS TECHNOLOGY

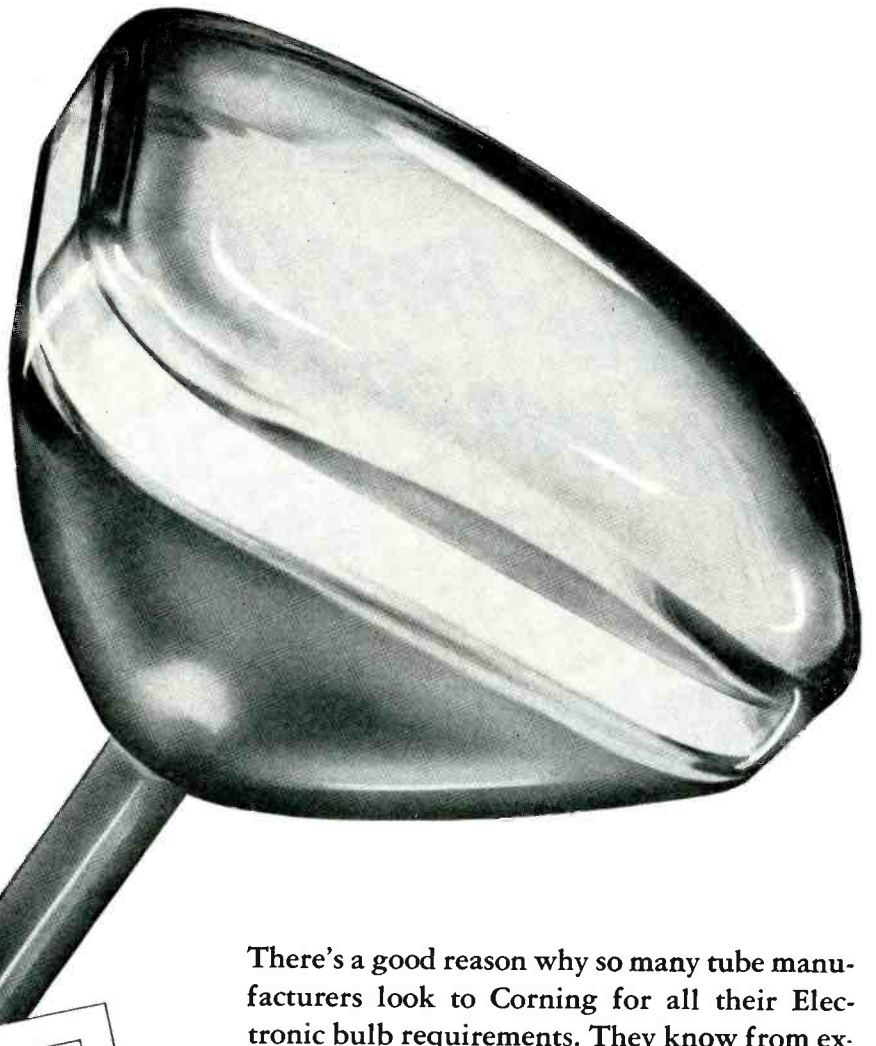

CORNING
is at Your Service

There's a good reason why so many tube manufacturers look to Corning for all their Electronic bulb requirements. They know from experience that Corning's technical services will help them maintain maximum production efficiency—that Corning is "at your service" in many ways.

Corning's staff of highly trained and experienced specialists in glass working techniques, quality control, product engineering and design are ready to help solve your tube processing problems. They will work with your production personnel on any problem concerning the use of glass, from detecting operating variables which cause shrinkage to the properties of glass itself.

Complete technical service is but one reason why it pays to do business with Corning—the one source for *all* your bulb requirements.



CORNING GLASS WORKS, CORNING, N. Y.

Corning means research in Glass

ELECTRONIC SALES DEPARTMENT—ELECTRICAL PRODUCTS DIVISION

1851 • 100 YEARS OF MAKING GLASS BETTER AND MORE USEFUL • 1951

MODEL VH-91



FOR HIGH EFFICIENCY SOUND REPRODUCTION

MODEL VH-15



MODEL VH-20



Jensen Hypex Projectors for indoor and outdoor PA and sound reinforcement are highly efficient, sturdy, weather-proof, corrosion resistant loudspeakers with many exclusive advanced features. For example, the Hypex (hyperbolic exponential) flare formula—patent 2,338,262—provides the most effective acoustic loading right down to l. f. cut-off. Special plastic diaphragm driver unit gives powerful reproduction with a “punch”—yet free from unpleasant harshness. And soundly engineered adjustable mounting facilities make installation a pleasure.

MODEL VH-24



JENSEN MANUFACTURING COMPANY

Division of The Muter Company

6601 S. Laramie Ave., Chicago 38, Illinois
Phone; POrtsmouth 7-7600.

PROBLEM:

How to Get "Aluminum-to-Aluminum" Connections in the Termination of Aluminum Conductors

GENERAL PLATE:

Provided the Solution with the Composite Metal **ALCUPLATE***

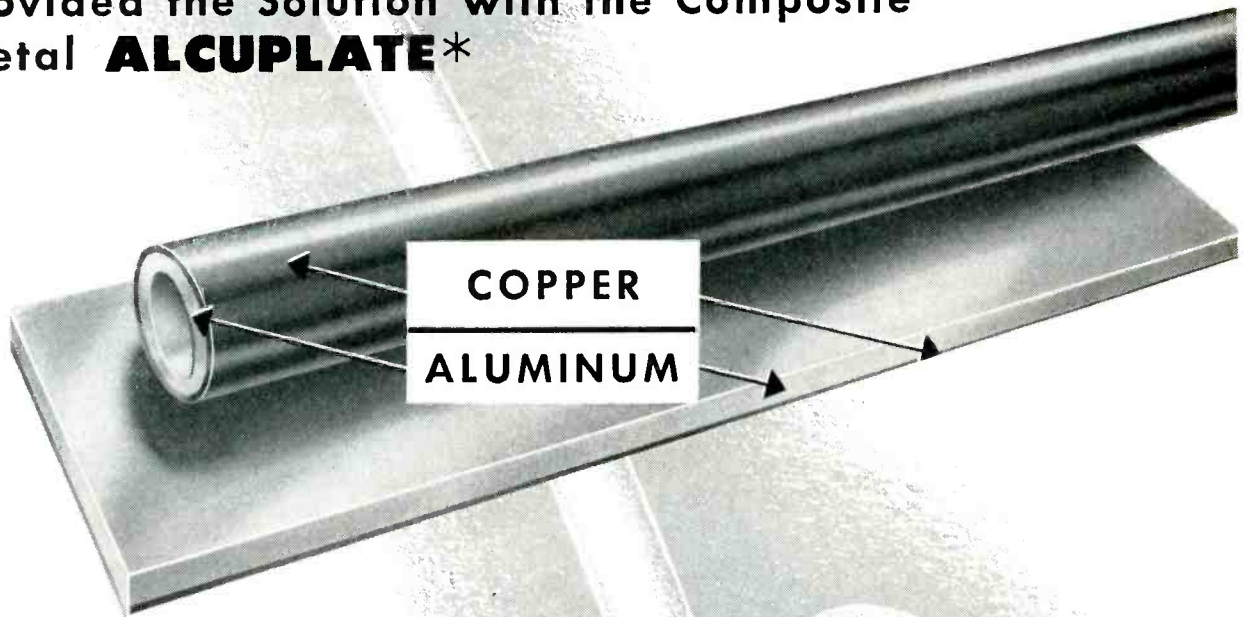

Aircraft manufacturers and power companies were troubled with the electrolytic action which took place when aluminum main line cables were joined to copper branch lines. To overcome this problem it was necessary to have aluminum-to-aluminum or copper-to-copper connections.

General Plate engineers solved the problem with *Alcuplate* (aluminum clad to copper) which gives like metal connections, thus overcoming the corrosion objections. *Alcuplate* is widely used in the electrical field for clips, shims, bushings, terminals, etc. Enclosures for sealed devices can be spun or drawn from *Alcuplate* and the copper surface makes soft soldering easy.

Alcuplate is available in sheet, strip or seamless tubing.

No matter what your metal problem, it will pay you to consult with General Plate. Their vast experience in cladding precious to base metals or base to base metals can overcome your problems . . . often reduce costs.

General Plate Products include . . . Precious metals clad to base metals, Base metals clad to base metals, Silver Solders, Composite contacts, buttons and rivets, Platinum fabrication and refining, Age-hardenable #720 Manganese Alloy. Write for information. *Reg. U. S. Pat. Off.

Have You a Composite Metal Problem?
General Plate can solve it for you

GENERAL PLATE
Division of Metals & Controls Corporation
307 FOREST STREET, ATTLEBORO, MASS.

Rauland Now Offers The First **LOW FOCUS VOLTAGE ELECTROSTATIC TUBE**

Rauland's new low potential electrostatic-focus picture tube is not just a "defense period" substitute but a permanent and major advance in television cathode ray tube development

FOCUSES with D.C. voltage already available from the receiver's power supply.

ELIMINATES focusing coils and magnets—saves critically scarce copper and cobalt.

REQUIRES NO re-engineering of present television chassis . . . **NO** added high voltage focus circuit . . . **NO** added receiver tubes—**NO** additional components except an inexpensive potentiometer.

BETTER in all ways! Not only saves materials but also gives an actual improvement in picture quality because the over-all focus is better . . . and because it is completely stable in focus under considerable variations in voltage.

This new Rauland development is now available in substantial quantities in 17 and 20 inch rectangular tubes. For further information, address . . .

THE RAULAND CORPORATION



Perfection Through Research

4245 N. KNOX AVENUE • CHICAGO 41, ILLINOIS



Never Before!

STABLE DURING EXTREME TEMPERATURE AND HUMIDITY CHANGES—*for MILITARY USE*

Delivers top performance in an unprecedented temperature range from the bitterest cold in arctic regions or extreme altitudes to fiery hot tropical battlefields . . . and in an unparalleled humidity range from complete aridity to the saturation point.

Highly recommended for use in airplanes, tanks, ships, portable or mobile equipment and

all other military communications.

Manufactured from specially developed materials, this absolutely unique variable resistor is available in miniaturized size (Type 65) or in conventional size (Type 95) in resistance ranges from 250 ohms to 10 megohms.

Exceptionally good delivery cycle due to tremendous precision mass production facilities.

Please give complete details on your requirements when writing or phoning for further information.

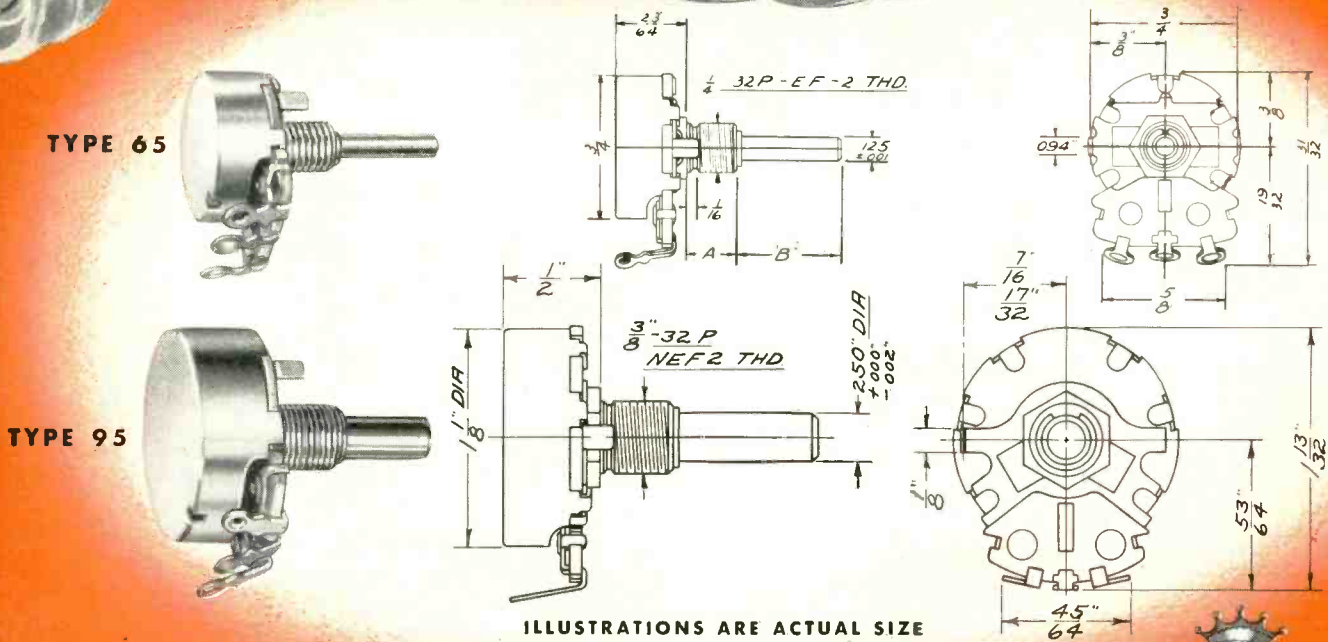

ILLUSTRATIONS ARE ACTUAL SIZE

A COMPLETE LINE OF VARIABLE RESISTORS (COMPOSITION AND WIRE WOUND) WITH OR WITHOUT ASSOCIATED SWITCH COMBINATIONS



CHICAGO TELEPHONE SUPPLY Corporation

ELKHART • INDIANA

Specialists in Precision Mass Production of Variable Resistors

FOUNDED 1896

REPRESENTATIVES

S. J. Hutchinson, Jr.
401 North Broad Street
Philadelphia 8, Pennsylvania
Phone: Walnut 2-5369
W. S. Harmon Company
1638 South La Cienega Blvd.
Los Angeles, California
Phone: Axminister 3-6219

SOUTH AMERICA

Jose Luis Pontet
Buenos Aires, Argentina
Montevideo, Uruguay
Rio de Janeiro, Brazil
Sao Paulo, Brazil

IN CANADA

C. C. Meredith & Co.
Streetsville, Ontario

OTHER EXPORT

Sylvan Ginsbury
8 West 40th Street
New York 18, N. Y.

meets JAN-R-19

**VARIABLE WIRE WOUND
RESISTORS TO ALL SPEC-
IFICATIONS IN JAN-R-19**

TYPES NOW AVAILABLE

JAN TYPE	CTS TYPE	WATT RATING
RA 20A	252 (without switch)	2
RA 20B	GC-252 (with switch)	2
RA 25A	25 (without switch)	3
RA 25B	GC-25 (with switch)	3
RA 30A	25 (without switch)	4
RA 30B	GC-25 (with switch)	4

Exceptionally good delivery cycle due to tremendous precision mass production facilities.

Please give complete details on your requirements when writing or phoning for further information.

ILLUSTRATIONS ARE ACTUAL SIZE.

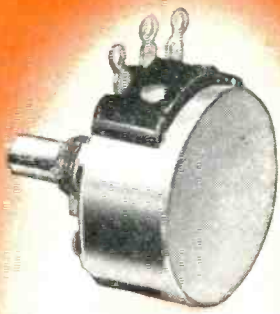

JAN Type RA 20A
2 Watt (CTS Type 252)

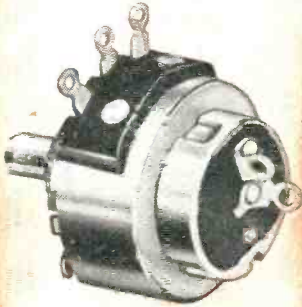

JAN Type RA 20B
2 Watt (CTS Type GC-252)

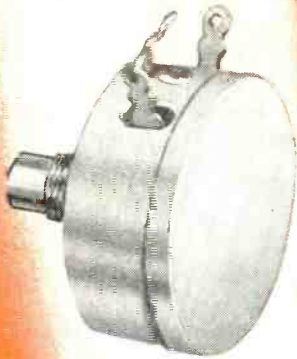

JAN TYPE RA 25A
3 Watt (CTS Type 25)

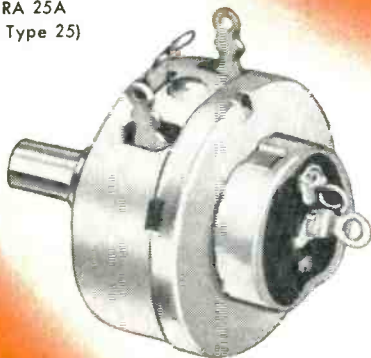

JAN Type RA 25B
3 Watt (CTS Type GC-25)

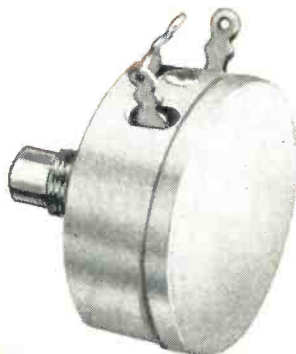

JAN Type RA 30A
4 Watt (CTS Type 25)

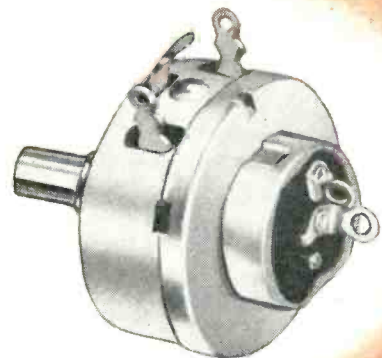

JAN Type RA 30B
4 Watt (CTS Type GC-25)



**CHICAGO TELEPHONE SUPPLY
Corporation**

ELKHART * INDIANA

REPRESENTATIVES

S. J. Hutchinson, Jr.
401 North Broad Street
Philadelphia 8, Pennsylvania
Phone: Walnut 2-5369

W. S. Harman Company
1638 South La Cienega Blvd.
Los Angeles, California
Phone: Administer 3-6219

IN CANADA

C. C. Meredith & Co.
Streetville Ontario

SOUTH AMERICA

Jose Luis Pontet
Buenos Aires, Argentina
Montevideo, Uruguay
Rio de Janeiro, Brazil
Sao Paulo, Brazil

OTHER EXPORT

Sylvan G. Embury
8 West 47th Street
New York 8, N. Y.

A COMPLETE LINE OF VARIABLE RESISTORS (COMPOSITION AND WIRE WOUND) FOR MILITARY APPLICATIONS:

*Specialists in Precision Mass Production
of Variable Resistors*

FOUNDED 1896

Watch  *Master*

Frequency Standards



**GUARANTEED
ACCURACY**
1 part in 100,000
(.001%)

Type 212

TERMINATION

Front and Rear

CONSTRUCTION

Standard 8 $\frac{3}{4}$ " x 19" Panel

HOUSING

8 $\frac{3}{4}$ " x 19" x 8" Metal Cabinet

WEIGHT

25 pounds

Uses

Time bases, rate indicators, clock systems, chronographs, geo-physical prospecting, control devices and for running small synchronous motors.

Features

1. Bimetallic, temperature-compensated fork, no heating or heat-up time is required.
2. Fork is hermetically sealed, no barometric effects on frequency.
3. Precision type, non-ageing, low coefficient resistors used where advantageous.
4. Non-linear negative feedback for constant amplitude control.
5. No multi-vibrators used.
6. Synchronous clock simplifies checking with time signal.

Specifications

Accuracy—1 part in 100,000 (.001%).

Temperature coefficient—1 part in 1,000,000 per degree centigrade (or better).

Outputs—

1. 60 cycles, sine wave, 0-110 volts at 0 to 10 watts (adjustable).
2. 120 cycle pulses, 30 volts negative.
3. 240 cycle pulses, 30 volts positive and negative. Pulse duration, 100 micro-seconds.

product of

**AMERICAN TIME PRODUCTS
INC.** New York 19, N. Y.

580 Fifth Avenue
Operating under patents of the Western Electric Company

American Time Products, Inc.,
580 Fifth Ave., New York 19, N. Y.

Gentlemen:

Please send descriptive folder, No. 212

Name.....

Company.....

Address.....

City..... State.....

Why tap?

SAVE TIME AND MONEY WITH

SHAKEPROOF

T. M. Reg. U. S. Pat. Off.

THREAD-CUTTING SCREWS

AND GET STRONGER, TIGHTER FASTENINGS, TOO!

separate tapping is completely eliminated—no tapping time or tool costs!

each screw fits tight in its own self-cut, mating thread—powerfully resists loosening!

greater strength permits use of smaller or fewer fastenings—saving space and weight.

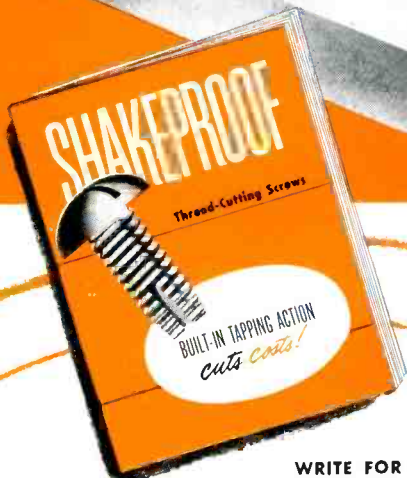

WRITE FOR YOUR FREE COPY OF THIS BOOKLET TODAY . . . and see how SHAKEPROOF Thread-Cutting Screws will speed urgent production in your plant.



TYPE 23
standard threads
with extra wide
thread-cutting slot.

TYPE 1
standard
threads, ideal for
steel.

TYPE 25
for plastics
with spaced threads
to minimize stripping.



SHAKEPROOF inc.

"Fastening Headquarters"
Trade Mark

A DIVISION OF ILLINOIS TOOL WORKS

2501 North Keeler Avenue • Chicago 39, Illinois

In Canada: Canada Illinois Tools Ltd., Toronto, Ontario

THE OFFNER DYNOGRAPH RECORDER

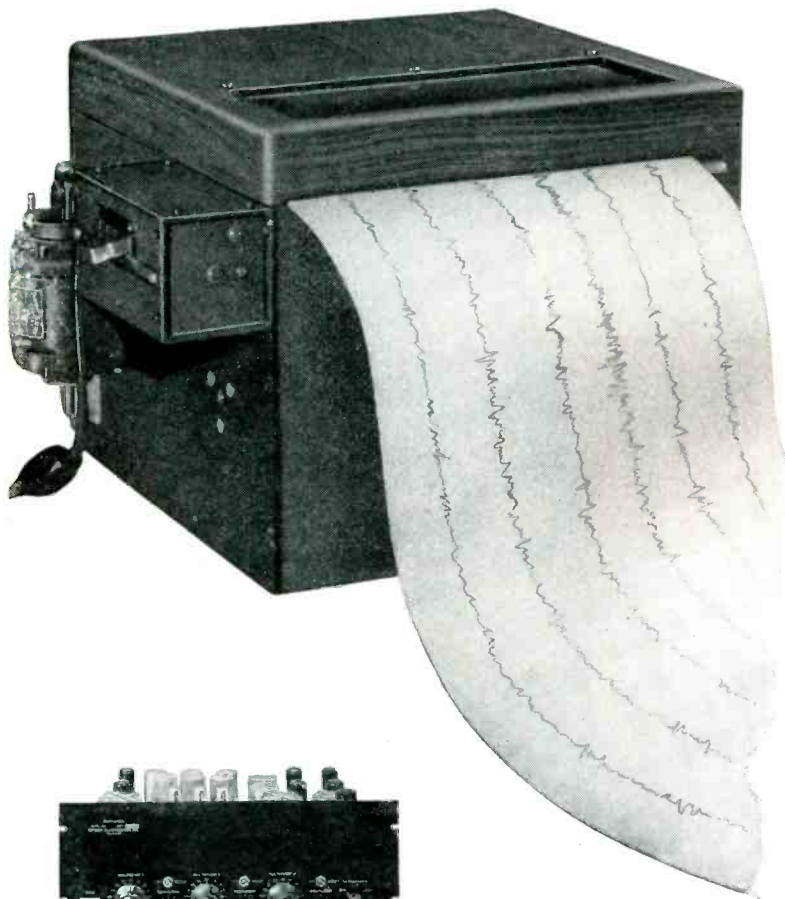

Type 133 Amplifier

**drift-free
d-c recording**

SPEED

TEMPERATURE

PRESSURE

VIBRATIONS

POSITION

OTHER VARIABLES

check these exclusive Dynograph features

Pen Deflection Linearity of 1% with pen response of 1/120th of a second.

Sensitivity of 150 microvolts d-c per centimeter of pen deflection.

Stability and drift-free operation through a special chopper type amplifier.

No extra equipment needed with reluctance type pick-ups.

True Differential input obtained through special transformer coupling.

Offner Electronics Inc., the original manufacturer of precision, direct writing oscillographs, now offers to industry the Dynograph Recorder—a direct writing, high speed oscillograph with microvolt d-c sensitivity.

Operating at approximately 100 times the speed of other industrial recorders with comparative sensitivity, the Dynograph simultaneously records many variables formerly recorded only by photographic means.

Now you can obtain a precise record of transients in the operation of various equipment through a ruggedly built, easy to maintain, versatile d-c recorder—the Dynograph.

Write Today for Bulletin L-311—Complete
Specifications and Construction Details of the Dynograph

OFFNER ELECTRONICS INC.

5320 N. KEDZIE AVENUE

CHICAGO, 25

3 TRUARC RETAINING RINGS LOWER COST... IMPROVE PERFORMANCE OF REVOLUTIONARY NEW TEXTILE SPINDLE!

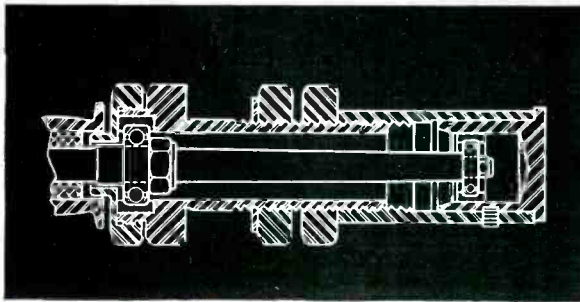
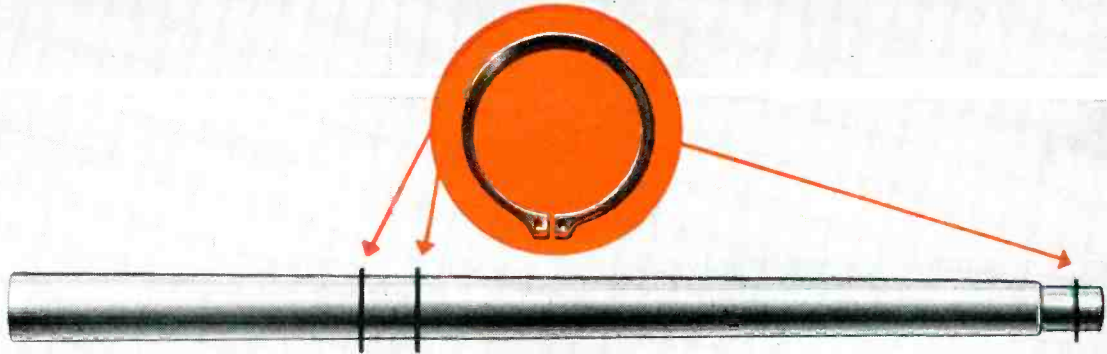

OLD CONSTRUCTION. To position 2 ball bearings, an oversize diameter rod had to be turned on a lathe to provide 3 shoulders. In addition, blade required 2 threading operations... 2 lock nuts... separate tapering operation. Proper pressure of nuts against ball bearings required skilled labor adjustment.

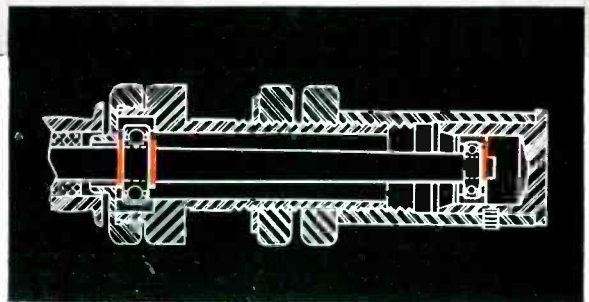

NEW CONSTRUCTION. Standard rod, equal in diameter to finished blade is used. Three grooves for Truarc Rings and shoulder are made quickly and easily on screw machine. Blade is economically tapered by centerless grinding. Truarc Rings maintain correct pressure on ball bearings for life of unit!

The H & B American Machine Company's new anti-friction CENTURY spindle is probably the most mechanically advanced spindle on the market today. Waldes Truarc Retaining Rings have eliminated many of the material, tooling and assembly costs... have kept its price competitive. Truarc Rings not only simplify spindle assembly, they position ball bearings accurately... simplify maintenance... eliminate skilled labor... improve performance! And there are Truarc Rings to solve any design or re-design problem!

Redesign with Truarc Rings and you too will cut costs.

Wherever you use machined shoulders, bolts, snap rings, cotter pins, there's a Waldes Truarc Retaining Ring designed to do a better job of holding parts together.

Truarc Rings are precision-engineered... quick and easy to assemble and disassemble. Always circular to give a never-failing grip. They can be used over and over again.

Find out what Truarc Rings can do for you. Send your blueprints to Waldes Truarc engineers for individual attention, without obligation.

Waldes Truarc Retaining Rings are available for immediate delivery from stock, from leading ball bearing distributors throughout the country.

SEND FOR NEW BULLETINS →

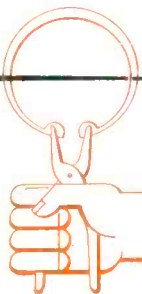

WALDES

TRUARC

REG. U. S. PAT. OFF.

RETAINING RINGS

WALDES KOHINOOR, INC., LONG ISLAND CITY 1, NEW YORK

WALDES TRUARC RETAINING RINGS ARE PROTECTED BY THE FOLLOWING PATENT NUMBERS: 2,382,947; 2,382,948; 2,416,852; 2,420,921; 2,428,361; 2,487,802; 2,487,803; 2,491,306; 2,491,310; 2,509,081; AND OTHER PATS. PEND.



Waldes Kohinoor, Inc., 47-16 Austel Place
Long Island City 1, N. Y.

E073

Please send Bulletins 6, 7 and 8—giving engineering specifications for all types of Waldes Truarc Rings.

Name _____

Title _____

Company _____

Business Address _____

City _____ Zone _____ State _____

678



*Messages or Missiles...
...the men who
dispatch them count
on Veeder-Root...
...in fact...*

Everyone Can Count on **VEEDER-ROOT**



Radar, communications, gunfire Control... and many other military "musts"...count on Veeder-Root Counters for dependable, continuous Facts-in-Figures. Never mind how. Just count on it that the job is being done... right up "to the nines."

If *anything* is worth keeping track of,

then you can count on Veeder-Root to do the job as it needs to be done...within the limitations of defense production, of course.

VEEDER-ROOT INC.

HARTFORD 2, CONN. • GREENVILLE, S. C.
Montreal, Canada Dundee, Scotland

Offices and agents in principal cities

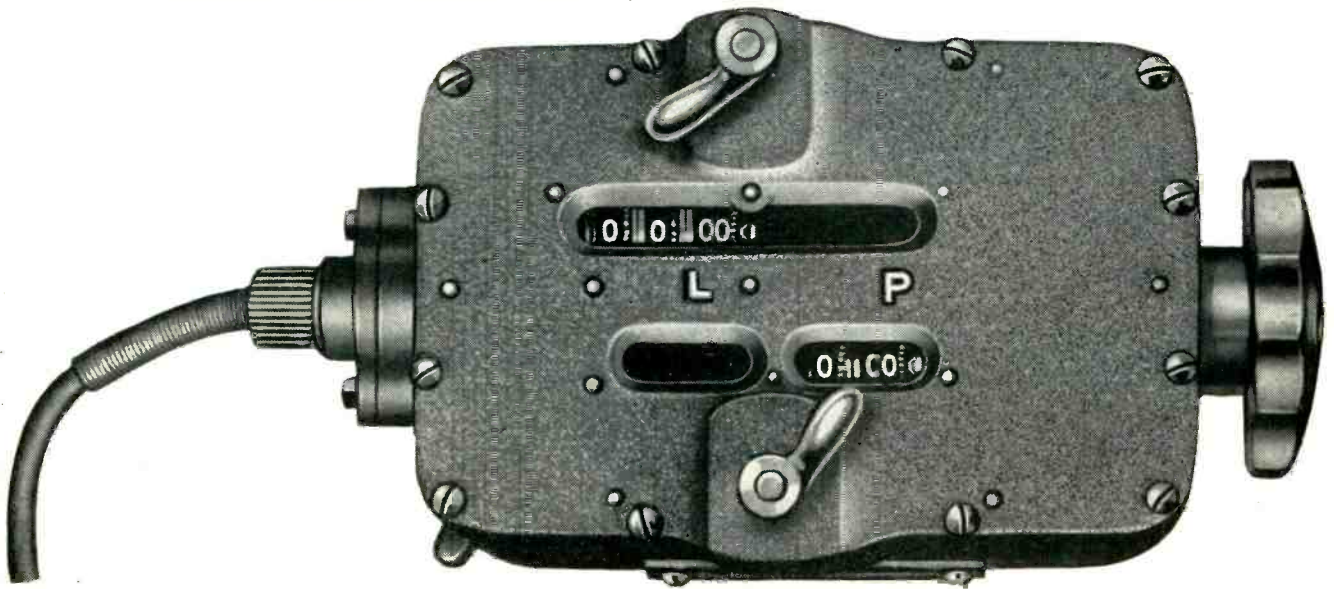

VEEDER-ROOT **COUNTERS** *"Count Everything on Earth"*

TV DESIGNER'S DEFENSE PROBLEM



"Can standard receiving tubes be specified for military electronic equipment?"



GL-5654



In some cases, no. But all General Electric 5-STAR TUBES are on the Armed Services' Preferred List. They're the last word in dependability! Every 5-Star Tube gets 48 hours' service at the factory under Class A conditions. Frequent life tests also are made. During manufacture, 5-Star Tube parts are inspected individually prior to careful and precise hand-assembly.

That new military circuit you've been asked to design, will do its task better—far more reliably—with G-E 5-Star Tubes to help assure steady performance under fire. You have nine types to choose from, covering a wide range of applications. Other types will be added later. They will further extend G-E 5-Star usefulness.

Aviation—for which 5-Star Tubes originally were developed—pays enthusiastic tribute to the job these special G-E tubes have done in making airborne travel safer. Now General Electric offers the same fine tube performance to you, so that equipment you're designing may approach absolute standards of reliability—may meet stiff military performance requirements. Fill out, clip, and mail the coupon below! Electronics Department, General Electric Company, Schenectady 5, New York.

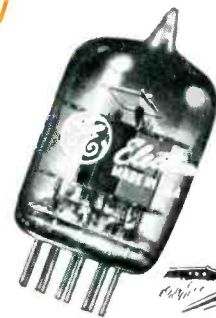

GL-5670



GL-5686



- GL-5654** Sharp-cutoff r-f pentode
- GL-5670** H-f twin triode
- GL-5686** Beam power amplifier
- GL-5725** Dual-control sharp-cutoff r-f pentode
- GL-5726** Twin diode
- GL-5749** Remote-cutoff r-f pentode
- GL-5750** Pentagrid converter
- GL-5751** High-mu twin triode
- GL-5814** Medium-mu twin triode

General Electric Company—Section 4,
Building 267—Schenectady 5, N. Y.

Please mail me the facts about G-E 5-Star Tubes—their performance characteristics; how they are manufactured, how tested.

Please have a tube engineer call on me, to discuss G-E 5-Star Tubes and their applications in circuits I am designing.

NAME.....COMPANY.....

STREET ADDRESS.....CITY, STATE.....

GENERAL ELECTRIC



181-K3

When performance exceeds promise!

We promised you better resistors than had been available before. Our new crazeless, blue-gray enamel resistors are **out-performing** our highest expectations in the field.

Let us summarize the improvements you get in these new Hardwick, Hindle resistors:

1. Crazeless—complete elimination of the crazing which results in failure of the resistive element due to moisture penetration from humidity, salt and severe atmospheric conditions—providing greater dielectric strength.

2. High temperature qualifications—provide greater safety factor under abnormal operating conditions.

3. Stronger core—gives greater resistance to excess vibration and shock test.

4. Alloy terminals—greater strength—corrosion and rust resistant—spot-welded to the ceramic body.

5. Resistive element—finest quality wire free from impurities that could cause weakness.

6. Connections—all wire connections to terminals are protected by positive non-corrosive bonding.

The above factors give you absolute assurance of longer life and outstanding performance.

The fixed, the ferrule and the flat types are designed for and manufactured in accordance with JAN-R-26A specifications.

HARDWICK, HINDLE, INC.

Rheostats and Resistors

Subsidiary of

THE NATIONAL LOCK WASHER COMPANY

Established 1886

NEWARK 5, N. J.

U.S.A.

the mark



of quality

for more than a quarter of a century

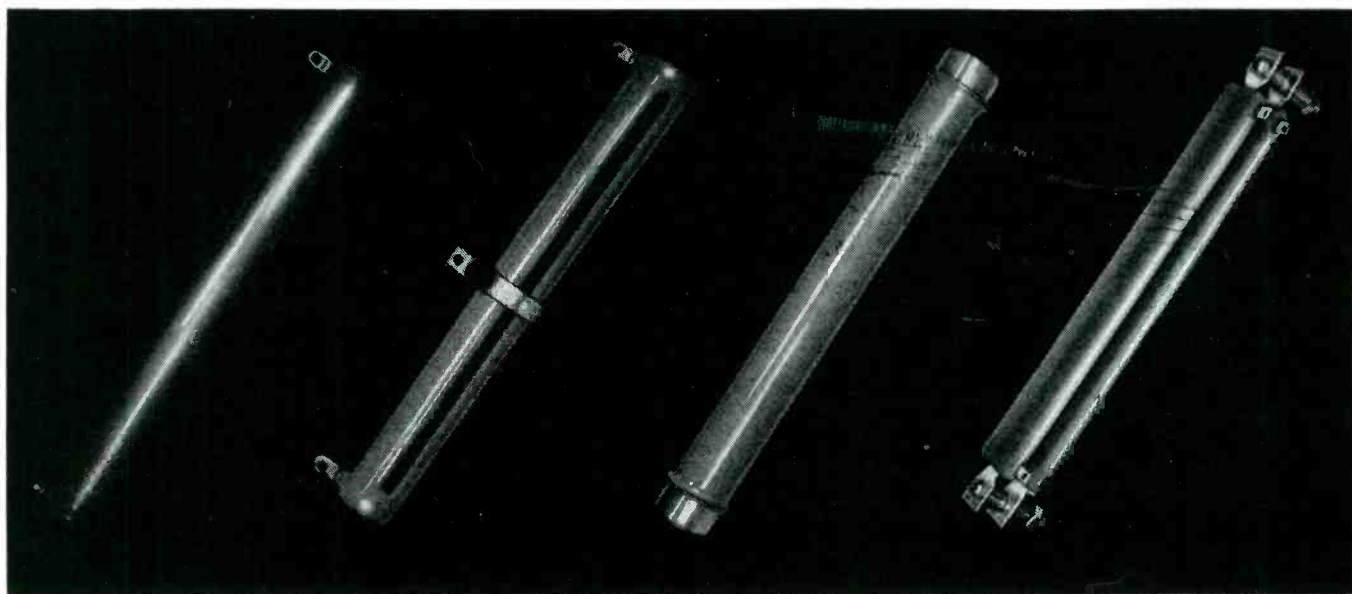

"One Picture Is Worth a Thousand Words"



Trade Mark
Registered

PICTURE this trade mark in your mind when you want cabinets and housings to enhance your finished products with step-ahead styling... absolute uniformity... ease and economy in your assembly operations... greater service benefits to the user. The Blueprint Man symbolizes all this, on jobs both simple and exacting... at prices figured with a sharp pencil. Write for our data book.

Visit us at booth #20.
Pacific Electronic Exhibit.
San Francisco—August 22-24.

KARP METAL PRODUCTS CO., INC.

215 63rd STREET, BROOKLYN 20, NEW YORK

Specialists in Fabricating Sheet Metal for Industry

PEAK

IN
POWER
VERSATILITY
QUALITY
PERFORMANCE

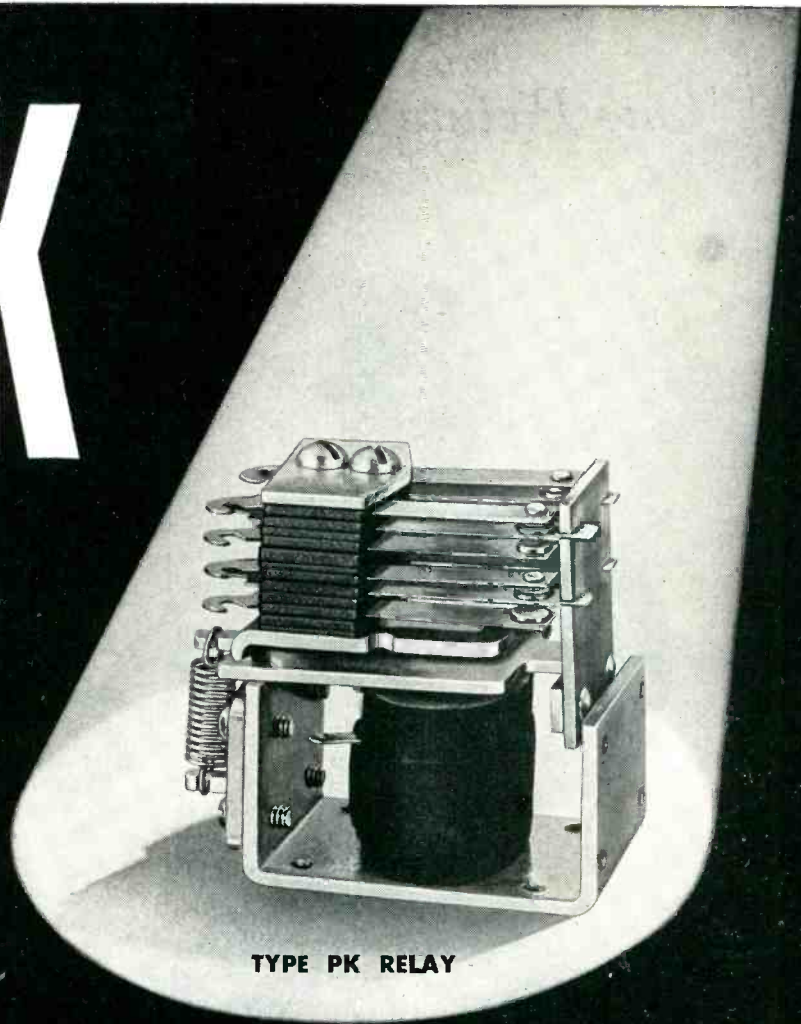

TYPE PK RELAY

HERE ARE THE FACTS AND FIGURES:

CONTACTS: 10 amp. standard. 24 volts D.C., 115 volts A.C.
15 amp. contacts available.

SENSITIVITY: D.C.: 4 pole 1.5 watts
2 pole .7 watts
A.C.: 4 pole 5 volt amperes
2 pole 2.5 volt amperes
Can also be furnished in 6 pole AC
and DC up to 4000 Ohms.

COIL: To 115 volts D.C., 230 volts A.C.

NOMINAL HEAT RISE: D.C. 30°C above room ambient
A.C. 45°C above room ambient

MAX. INPUT FOR 85° RISE: D.C. 5 watts
A.C. 11 volt amperes

MOUNTING: Base or end mounting

WEIGHT: 4.5 oz. 4 P.D.T.

WEIGHT HERMETICALLY SEALED: 7.7 oz.

DIMENSIONS: Open Relay— $2\frac{1}{16}$ " \times $1\frac{1}{8}$ " \times $2\frac{1}{16}$ "
Sealed Relay— $3\frac{1}{8}$ " \times $1\frac{1}{2}$ " \times $2\frac{5}{16}$ "
Overall Mounting Flange— $3\frac{1}{8}$ "
Center to Center Mounting Holes— $2\frac{1}{16}$ "

A Quality Relay

The new Allied PK Relay is designed to offer versatility in a power relay where quality and low cost are factors. Besides stability in operation its reliability allows a range in applications from high quality instruments to vending machines. The PKU relay will comply with Underwriters' Laboratories requirements and can also be supplied hermetically sealed.

Bulletin PK gives complete details. Send for your copy today.

Be sure to send for your copy of Allied's Relay Guide. It gives the engineering data for 27 Allied relays in a concise tabular form for easy reference.



AL-143

ALLIED CONTROL COMPANY, INC. 2 EAST END AVENUE, NEW YORK 21, N.Y.



GOT A HOOK-UP PROBLEM?

Then you'll want to know about **Synkote**® wire

W-H-Y???

Well, right off the bat, there's the fact that many types of Synkote Hook Up Wire are approved constructions, conforming to JAN-C-76. SO... they fit right into a big share of the jobs that the electronics industry is working on today.

Or you can pick other constructions for special requirements. If yours is a "hot spot" application, for instance, use Synkote wire that carries UL approval for continuous operation at 105°C.

You can get Synkote wire in all the sizes used in electronic applications; with nylon jacketing or with woven glass, rayon or cotton braid; with shielding to meet any requirements; with one, two or three color stripes in addition to the full standard color coded line.

And of course, all constructions give you all the advantages for which Synkote thermoplastic insulation has long been famous. Almost complete imperviousness to water, acids, alkalis, oils, sun-light, heat, cold, fungus growths. Exceptional resistance to abrasion, flexing and tearing. Naturally, high dielectric strength and low dielectric leakage!

Other Synkote Products

AIRCRAFT CABLE

COAXIAL CABLE

TV WIRE

MULTI-CONDUCTOR CABLE

Engineering Service

Just tell us your requirements in electronic wiring. We'll be glad to help you select, from the comprehensive Synkote line, the type of insulated conductor that best meets your needs. And we're prepared, on short notice, to engineer new designs to fit your problem — and to produce them in practically any quantity.

Worth looking into, isn't it? Mail coupon for full information.

PLASTOID Corporation

42-61 24th Street, Long Island City 1, N. Y.

PLASTOID CORPORATION, Dept. E
42-61 24th Street • Long Island City 1, N. Y.

Gentlemen:

Please send me additional information on Synkote Hook Up Wire Type.....

Name.....

Company.....

Address.....

City..... State.....

Again a
D-H ALLOY
contributes as

RCA
introduces new
ELECTROSTATIC-FOCUS
TV TUBES

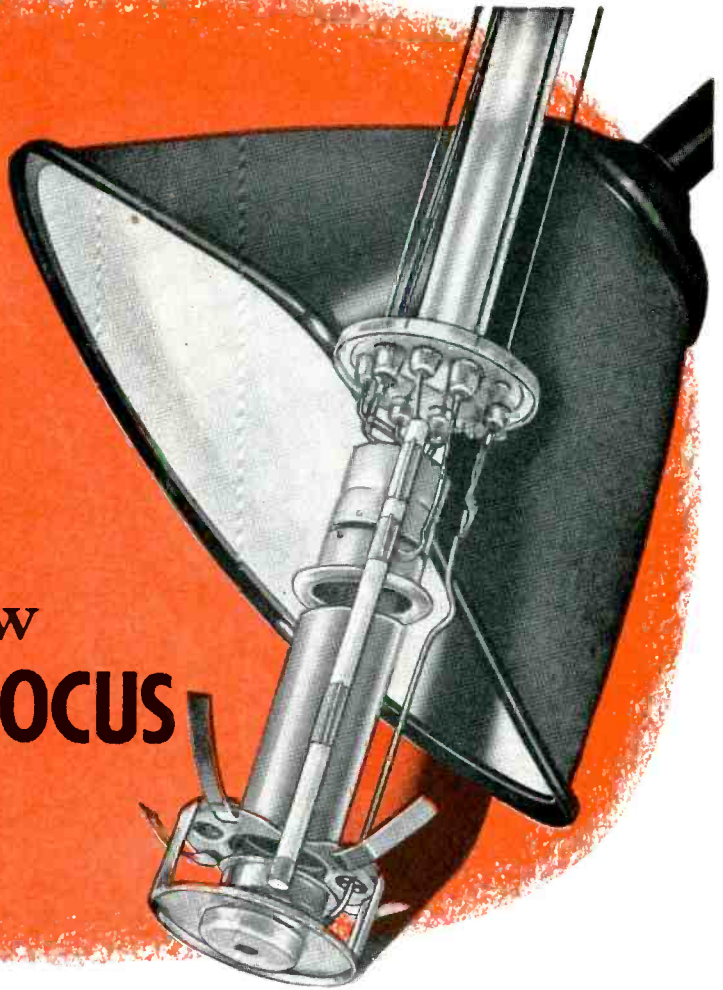

Once more, RCA leads the field! This time, with new rectangular picture tubes which require no focusing coil or focusing magnet . . . thus effecting important savings in critical materials.

The currently used magnetic focus in TV sets requires coils and magnets containing the metals cobalt and copper . . . both on the Government's restricted list.

To meet the shortages, RCA engineers have developed improved electrostatic focusing for wide-deflection-angle TV tubes—eliminating need for a focusing magnet or coil. Result: The new RCA kinescopes—which not only make possible savings in critical materials, but introduce advantages that destine them to become industry's most widely used picture tubes.

Such advantages, for example, as: (a) An improved electron gun which provides excellent uniformity of focus over the entire picture area, and is so designed that the focusing electrode takes negligible current—permitting voltage for the electrode to be supplied easily and

economically; (b) Focus automatically maintained with variation in line voltage and adjustment of picture brightness; (c) Simplification of tube installation and adjustment for optimum performance.

When RCA produced its outstanding Image Orthicon, "eye" of the television camera, it called upon the superlative Driver-Harris radio alloy Nichrome* V to provide 95% of the metal components of the tube. Now, in the case of the kinescopes, a Driver-Harris produced alloy fills a need.

Here are typical examples of how Driver-Harris stands ready to serve all industry with alloys necessary for new or standard applications.

During the present emergency, of course, strategic materials and the alloys made from them are on strict allocation. However, we shall be glad to make recommendations based upon your specific needs, and serve you to the best of our ability.

Makers of world-famous Nichrome and over 80 other alloys
for the electronic, electrical and heat-treating fields*

Driver-Harris Company
HARRISON, NEW JERSEY

BRANCHES: Chicago, Detroit, Cleveland, Los Angeles, San Francisco

In Canada: The B. GREENING WIRE COMPANY, LTD., Hamilton, Ontario, Canada



*T. M. Reg. U. S. Pat. Off.



BRASS AND COPPER WIRE CLOTH

Have you a "DO" order?

When you need Industrial Wire Cloth or Strainer Cloth for a Defense Order, your nearest Chase Warehouse is the place to inquire for it.

Chase Brass and Copper Wire Cloth is available in meshes from No. 2 to No. 100 and in varying gauges for a wide variety of industrial uses. The mesh is uniform and the wires double crimped to keep openings square and true.

One of the 23 Chase Warehouses or the four Chase Sales Offices will give you full information on the type of wire cloth best suited for your production problem. Send the coupon below for free Chase book describing the full line of Chase Brass and Copper Wire Cloth.

Chase BRASS & COPPER

WATERBURY 20, CONNECTICUT • SUBSIDIARY OF KENNECOTT COPPER CORPORATION

• The Nation's Headquarters for Brass & Copper

Albany†	Chicago	Denver†	Kansas City, Mo.	Newark	Pittsburgh	San Francisco
Atlanta	Cincinnati	Detroit	Los Angeles	New Orleans	Providence	Seattle
Baltimore	Cleveland	Houston†	Milwaukee	New York	Rochester†	Waterbury
Boston	Dallas	Indianapolis	Minneapolis	Philadelphia	St. Louis	(†sales office only)



FREE Chase Book lists mesh, diameter of wire, per cent of open area, weight and other important data.

Chase Brass & Copper Co., Dept. EL751
Waterbury 20, Conn.

Please send me your FREE book on Chase Brass & Copper Wire Cloth.

Name _____

Position _____

Firm _____

Address _____

City _____ State _____

NON-INSULATED COILS WOUND AT 5000 RPM

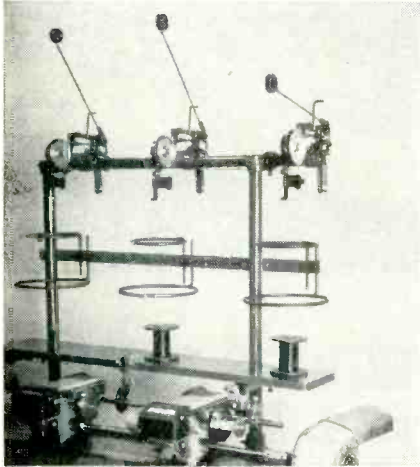

WINDING STARTS INSTANTLY WITHOUT DANGER OF WIRE BREAKAGE with the over-end tension. The first turn can be started tightly against the spool or bobbin head, improving "lay".

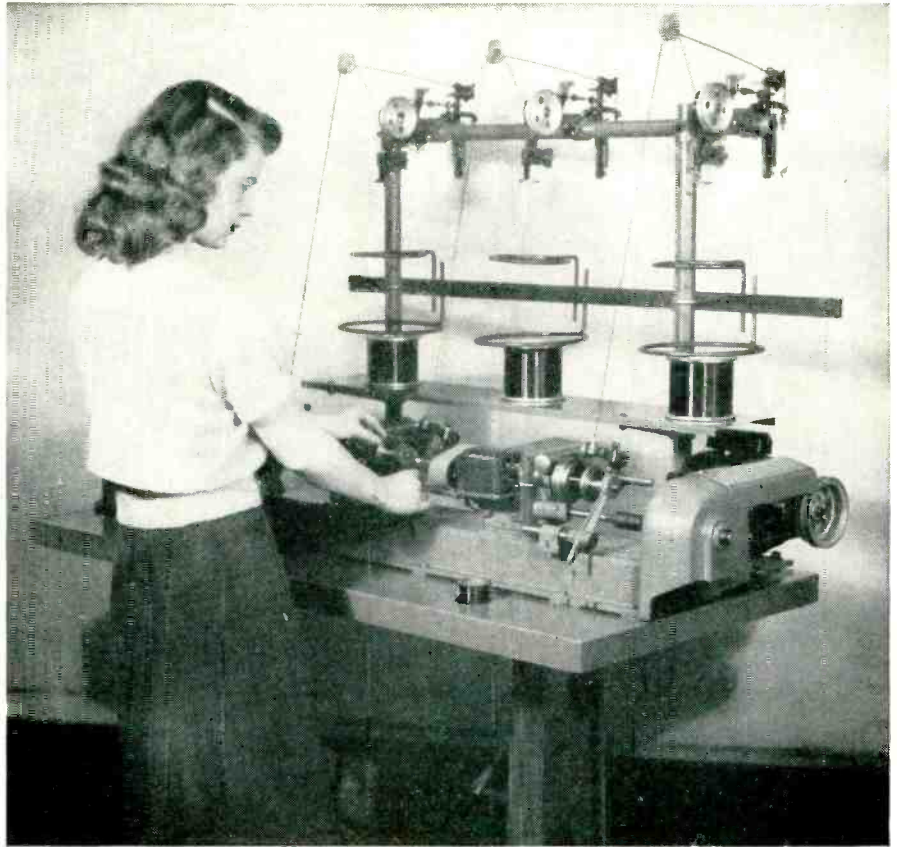

WHEN OPERATOR FINISHES manual procedure on one head, another coil will have just been completed. By synchronizing winding and handling time on the No. 102 Universal Hi-Speed Coil Winder, you get maximum production per operator. Coils up to 15,000 turns can as a rule be handled efficiently on a 3-head machine at a maximum of 5000 rpm.

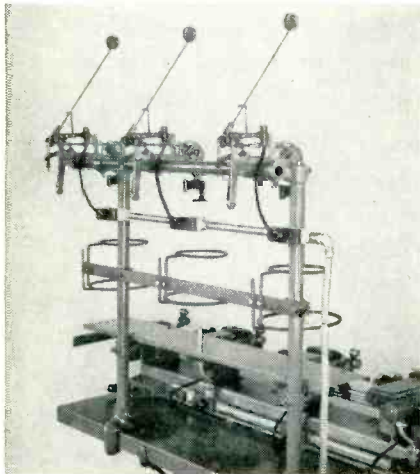

WIRE BREAKAGE DETECTOR is optional equipment for stopping arbor promptly when wire breaks or runs out. This relieves operator of having to watch wire spool continually and prevents counting of turns when wire is not being wound.

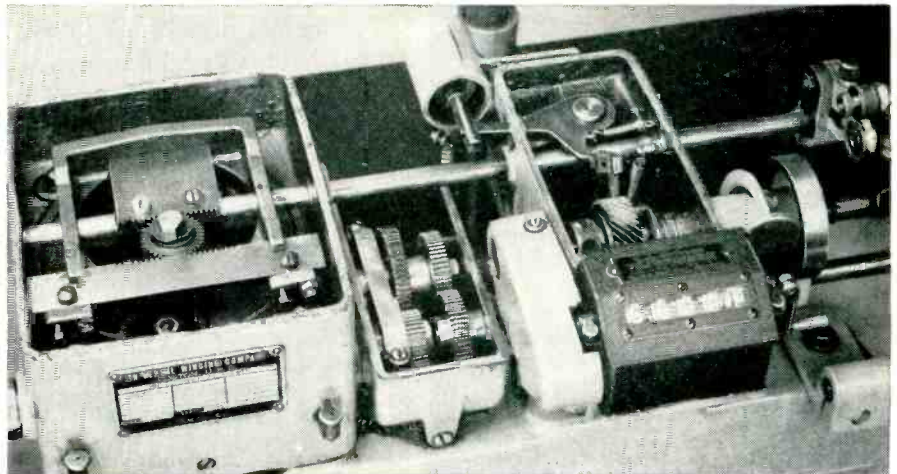

READILY-ADJUSTABLE TRAVERSE MECHANISM permits winding any length of coil from 1/16 in. to 2 13/16 in. without changing cams. A single setting applies to all the winding heads.

Write for Bulletin 102-H

UNIVERSAL WINDING COMPANY

P. O. Box 1605, Providence 1, R. I.

**For winding coils in quantity
accurately . . . automatically
use Universal Winding Machines**

238.1.1

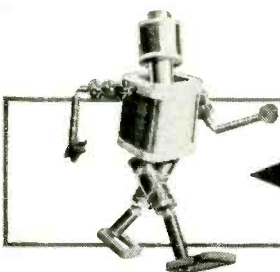



Lapp

GAS-FILLED CONDENSERS

More than 15 years service on thousands of Lapp Gas-Filled Condensers proves them to be completely reliable—electrically and mechanically. They offer the advantages of extreme compactness for high voltage and high current ratings... low loss... high safety factors... puncture-proof design... constant capacitance under temperature variation.

In construction, the condenser assembly is supported on a top aluminum ring, the steel tank serving only as a support for this ring and as a leak-proof gas container. The high potential plates are stationary, carried on a rigid aluminum center stud, supported by a ceramic bowl. Rotor plates are grounded, carried on ball-bearings in a race almost the full diameter of the tank. This construction provides a grounded tuning shaft on variable models, makes possible efficient and complete water cooling for high current operation, and results in direct and short current paths to condenser plates.

Write for complete description and specifications. Radio Specialties Division, Lapp Insulator Co., Inc., Le Roy, N. Y.



MODEL 24 IF
Fixed only

Capacitances up to 60,000 mmf.; 1 mc. current ratings: 175, 350, 525 amps.; Safety gap settings: 14, 25, 38 Kv peak.



MODEL 11 R—Fixed or Variable
MODEL 11 F—Variable only
MODEL 11 IF—Fixed only

Capacitances up to 30,000 mmf.; 1 mc. current ratings: 120, 240, 360 amps.; Safety gap settings: 6, 14, 25, 38, 50, 63, 72 Kv peak.



MODEL 12 R—Fixed or Variable
MODEL 12 IF—Fixed only

Capacitances up to 15,000 mmf.; 1 mc. current ratings: 105, 210, 315 amps.; Safety gap settings: 6, 14, 25, 38, 50, 63 Kv peak.



MODEL 9 R
Fixed or Variable

Capacitances up to 8000 mmf.; 1 mc. current ratings: 85, 170, 255 amps.; Safety gap settings: 6, 14, 25, 38, 50 Kv peak.



MODEL 7 R
Fixed or Variable

Capacitances up to 8000 mmf.; 1 mc. current ratings: 70, 140, 210 amps.; Safety gap settings: 2 1/2, 6, 14, 25, 38 Kv peak.



Designers



OIL-FILLED, HERMETICALLY SEALED, COMPACT HIGH VOLTAGE COMPONENTS

- **Withstand Mechanical Shocks**
- **Operate Continuously for Long Periods in Widely Varying Temperatures**

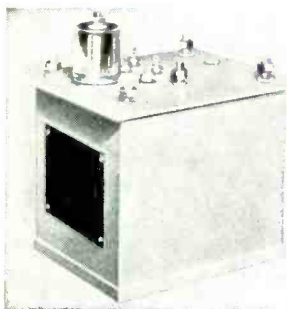

RECTIFIERS—A-c to d-c power-supply units especially built for precision work where unusually low regulation, light weight, and small size are necessary. Typical outputs available are 7, 9, and 13 kv. Illustrated 7-kv unit measures 6 x 6 x 7 in., weighs 8 lb.



PULSE TRANSFORMERS—For use with either hard-tube or line-type modulators. Available in peak-voltage ratings from 10 to 100 kv or higher; peak-power ratings up to 30,000 kva or more. Designed for operation on pulse durations from 0.1 to 20 microseconds at rates up to 4000 pps.



RESONANT REACTORS—Accurately designed and built for radar service. Currently available in peak operating voltages from 5 to 45 kv, current ratings up to 2.25 amp. Higher ratings can be provided. Inductance ratings ranging from 0.25 to 300 henrys remain constant within 5 percent at above 50 percent load current.



FILAMENT TRANSFORMERS—For special applications or for use with standard high-voltage rectifier tubes. Supplied with or without tube socket mounted integrally with high-voltage terminal. Insulated to nearly any required level.

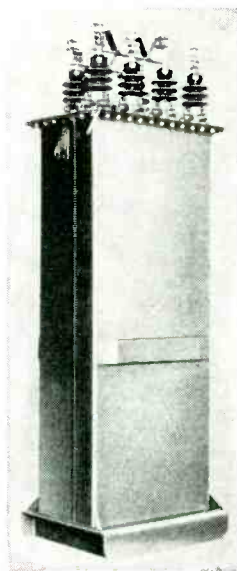

MODULATION TRANSFORMERS

—High-fidelity, low-phase shift, Pyranol* or oil-modulation transformers and reactors for high-power AM transmitters are available as integral or separate units. Highly developed designs in ratings from 3.5 to 500 kw provide wide transmission frequency range, keep down harmonic-voltage insertion. Low phase shift gives flexibility and range.

*Reg. TM of General Electric Co.

GENERAL ELECTRIC



667-16

Digest

TIMELY HIGHLIGHTS ON G-E COMPONENTS



DELAY LINES—ORDER IN BULK, CUT OFF AS MUCH AS YOU NEED



Signals with band widths up to 2 megacycles can be delayed from 0.25 to 10 microseconds. Available in lengths up to 100 ft. Delay equals approximately 1/2 microsecond per foot. Characteristic impedances of 1100 and 400 ohms per foot are available. By ordering in bulk, lengths can be cut to fit specific needs. Can be bent into 4-inch diameter coils. Uses include research and development of special circuits for electronic devices. See Bulletin GEC-459 for further information.



PHOTOVOLTAIC CELLS— MINIATURE POWER PLANTS

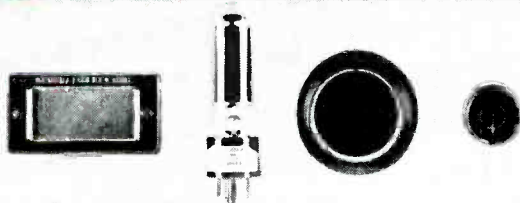

For accurately detecting, controlling, and measuring light and for detecting and measuring even the smallest variations in colors. These cells are especially useful where long life and stability are required or where electronic amplifiers are not practical. Available in a new hermetically sealed series with standard mounting and a wide variety of unmounted sizes. More G-E photovoltaic cells than any other make are used in scientific instruments. Characteristics, dimensions, circuits, and technical data are available in Bulletin GEC-690.



TRANSFER AND CONTROL SWITCH— OVER 10,000 POSSIBLE COMBINATIONS

Built for reliability and long service life, the G-E Type SB-1 transfer and control switch can be used for more than 10,000 possible circuit-sequence combinations. Precision construction permits as many as 40 stages—four banks of ten stages each—to be operated in tandem. Switches with up to 16 stages and 12 positions are commonly furnished. Ratings go up to 20 amp at 600 volts a-c or d-c. Standard components are interchangeable. Complete description in Bulletin GEA-4746.

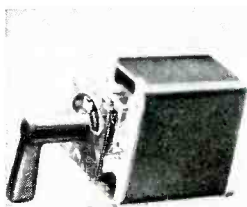

SELENIUM RECTIFIERS

... HIGH-VOLTAGE UNITS HAVE
LIFE EXPECTANCY OF OVER
60,000 HOURS

Now available from General Electric, these 26-volt RMS selenium rectifier cells have a continuous-service life expectancy of over 60,000 hours. Their initial forward resistance is very low and samples tested after 10,000 hours of operation show an average resistance increase of less than 6 per cent.

The high-voltage output means that stacks made up of these units are about 25 percent smaller than is possible with 12-volt cells. Low resistance means cooler operation and the space saving that goes with it.

If your application calls for compact selenium stacks for use in cramped quarters, these cells provide the solution. Stacks made with the new G-E cells may be obtained with rated outputs from 18 to 126 volts d-c at 0.15 to 3.75 amp. Check Bulletin GEA-5280.



General Electric Company, Section A667-16
Schenectady 5, N. Y.

Please send me the following bulletins:

- | | |
|----------------------------------------------------------------|-----------------------------------------------------------------|
| <input type="checkbox"/> (V) Indicate for reference only | <input type="checkbox"/> GEC-459 Delay Lines |
| <input type="checkbox"/> (x) For planning an immediate project | <input type="checkbox"/> GEC-690 Photovoltaic Cell |
| | <input type="checkbox"/> GEA-4746 Here's the All-Purpose Switch |
| | <input type="checkbox"/> GEA-5280 Selenium Rectifiers |

Name _____

Company _____

Address _____

City _____ State _____

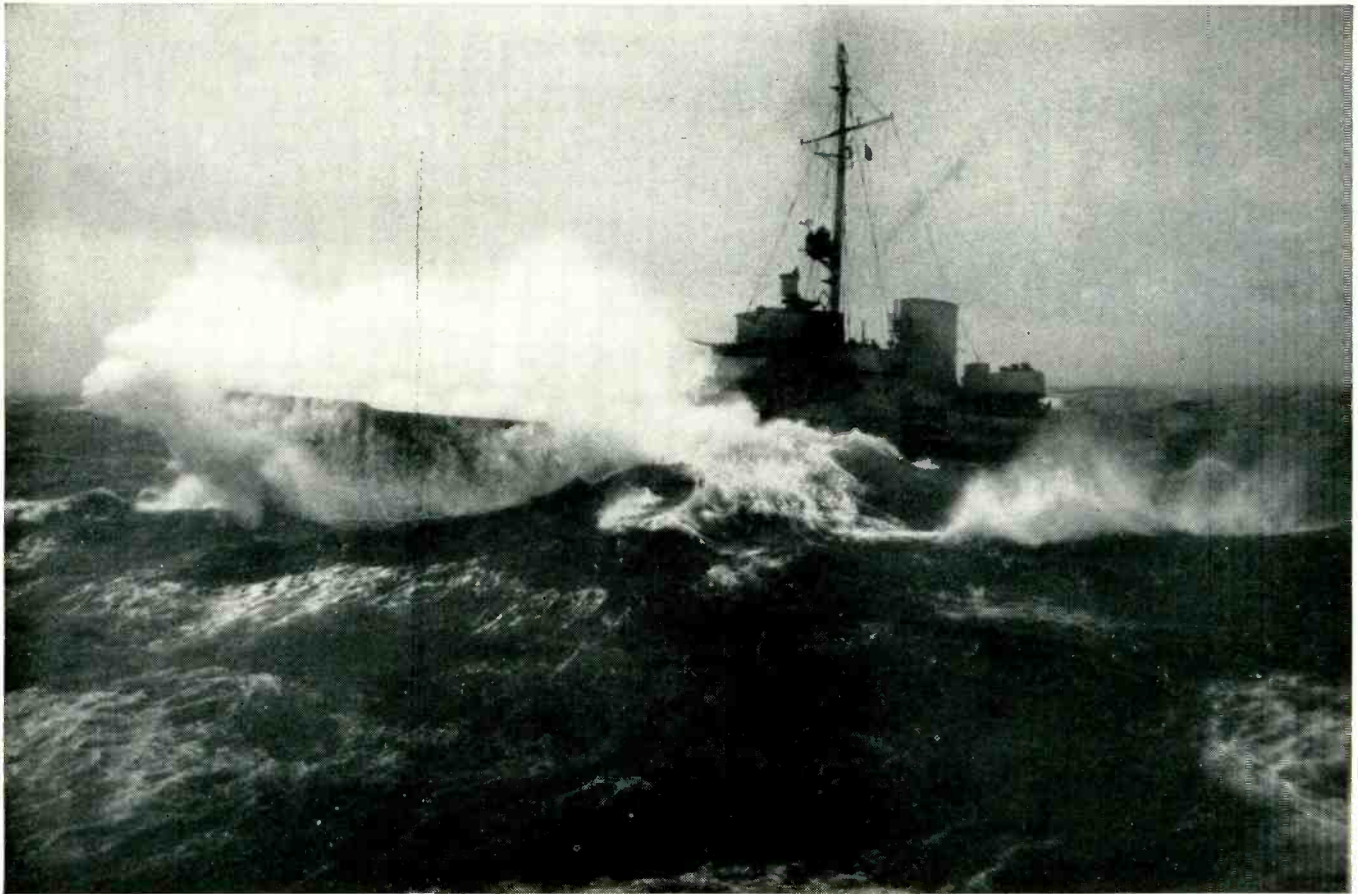

Official U. S. Coast Guard Photo

seamanship . . .

When the going gets rough, the safety of a ship depends largely on the seamanship of its crew and the good judgment of its officers. To help give the master of a ship full data on conditions contributing to the situation at hand, extraordinary new electronic devices ferret out underwater information of great value.

The Edo Corporation has become a leader in the design, development and manufacture of many of these new underwater detection devices which have far greater accuracy, range and dependability than previously thought possible.

Edo sonar equipments are being produced in ever increasing quantities to help give ships of the United States Navy better underwater "eyes" for both navigation and submarine detection.

OVER A QUARTER OF A CENTURY

Edo's emergence as a leader in the field of sonar development is the result of more than a quarter of a century of experience in the marine and aviation field.

To this intimate knowledge of a field where electronics has become increasingly important has been added the unexcelled experience of a staff of top electronic research and engineering personnel.

Edo development work in electronics, therefore, achieves not only increased electronic performance but does it while keeping in mind the practical necessities of rugged construction and miniaturization for space and weight saving.

If you'd like to learn more about Edo—our background, facilities, and products—we'll be glad to send you a copy of our 25th anniversary booklet. Just drop a note to Dept. M-7, Edo Corporation, College Point, L. I., N. Y.



EDO CORPORATION · COLLEGE POINT, N. Y.



DIFFERENT PHOTOTUBES

"CINTEL" PHOTOTUBES

are manufactured with three different types of cathode surface as follows:—

TYPE 'A' Antimony-Caesium, sensitive to day-light and blue light.

TYPE 'B' Bismuth etc. - Caesium, sensitivity similar to that of the human eye.

TYPE 'S' Silver-Oxygen-Caesium, sensitive to red-infra-red light.

There are over seventy different types covering every known application, and included in this range are:—

- ★ Push-pull types for double sound tracks
- ★ Special cells for dye image sound tracks
- ★ Cells of high insulation, linearity and stability for accurate photometric work
- ★ Cells for use in the ultra violet region of the spectrum
- ★ Multiplier cells
- ★ Transparent cathode cells, etc.

Full technical information will be rushed to you air mail, on application to—

CINEMA-TELEVISION LIMITED

A company within the Arthur Rank Organisation

FOREMOST IN THE MANUFACTURE OF

- Counters & Chronometers ● Metal Detectors ● Oscilloscopes ● Photo-Electric Cells
- Cathode Ray Tubes ● Geiger-Muller Tubes ● Electronic Instruments

WORSLEY BRIDGE ROAD • LONDON • S.E. 26
ENGLAND



TYPE VTA FLAT TRANSPARENT CATHODE



TYPE QVA.39 QUARTZ ENVELOPE SENSITIVE DOWN TO 1900 Å



TYPE VS.39 FOR ACCURATE PHOTOMETRIC WORK



"Quicker than Quick" ARCO



24 HOURS

COAST TO COAST DELIVERY

OF El-Menco CAPACITORS

LOS ANGELES

NEW YORK



EXPEDITING OFFICE

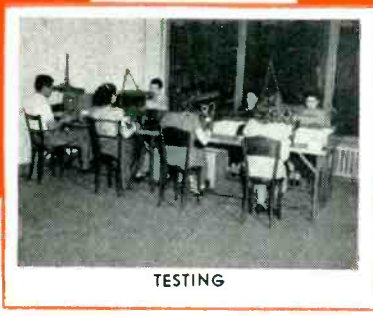

TESTING



UNIT INSPECTION & PACKAGING

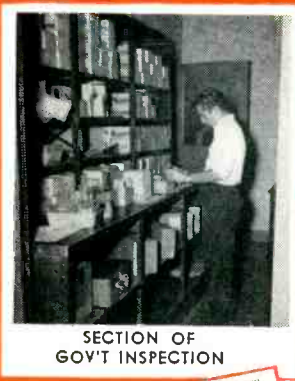

SECTION OF GOV'T INSPECTION

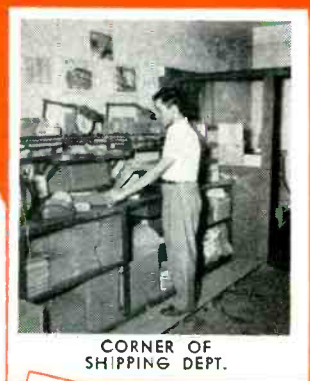

CORNER OF SHIPPING DEPT.

Manufactured In Accordance With JAN C-5 Spec.

**IN STOCK FOR SPOT DELIVERY
2,000,000 MICA CAPACITORS**

	From	To
CM15 Silvered Min. Mica Capacitors	1 MMF—	510 MMF
CM19 Foil or Silvered Mica Cap.	3 MMF—	1,000 MMF
CM20 Foil or Silvered Mica Cap.	3 MMF—	1,800 MMF
CM25 Foil or Silvered Mica Cap.	3 MMF—	2,000 MMF
CM30-35 Foil or Silvered Mica Cap.	5 MMF—	15,000 MMF
CM40 Foil or Silvered Mica Cap.	5 MMF—	15,000 MMF

Also A Complete Line Of:—

- Trimmers Ranging From 1.5 MMF to 780 MMF
- Padders Ranging From 15 MMF to 3,055 MMF
- Paper (Steatite) Ranging From .001 MFD to .5 MFD
- Ceramic (Silver High "K" Capacitors)
From 270 MMFD to 12,000 MMFD

ALL ABOVE UNITS ARE MANUFACTURED BY

THE ELECTRO MOTIVE MFG. CO. Inc.
WILLIMANTIC CONNECTICUT

Catalogue on Request — Write to

ARCO

ELECTRONICS INC.

103 LAFAYETTE ST., NEW YORK 13, N. Y.

Sole Agent for Jobbers and Distributors In U. S. and Canada.

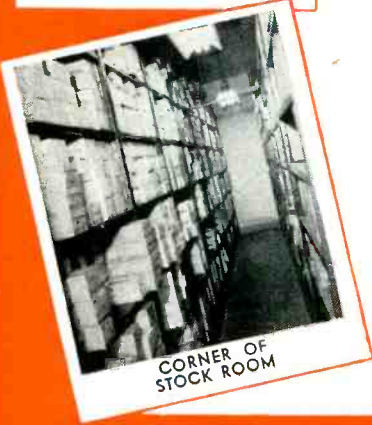

CORNER OF STOCK ROOM



ORDER SELECTION

\$15,000
A QUART



That's what it cost a prominent watchmaker to develop a type of oil suitable for its precision requirements. (Each worker is given a drop a day with which to oil 500 new watches.)

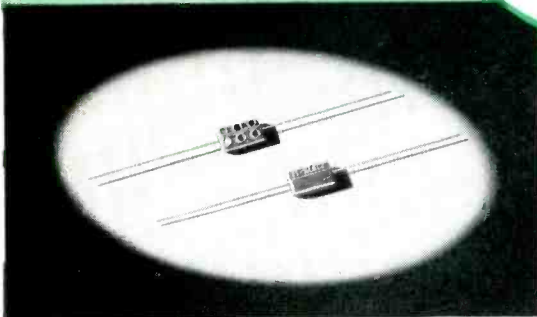

CM-15 MINIATURE CAPACITOR

Actual Size 9/32" x 1/2" x 3/16"

For Television, Radio and other Electronic Applications.

2 mmf.-420 mmf. cap. at 500v DCw.

2 mmf.-525 mmf. cap. at 300v DCw.

Temp. Co-efficient \pm 50 parts per million per degree C for most capacity values.

6-dot color coded.

That quantity is no indication of quality is amply demonstrated by the CM-15 El Menco Capacitor. Tiny as it is, it will give sustained superior performance under the most adverse conditions.

Before it leaves the factory it is tested at *double* its working voltage to *insure* this unflinching performance.

THE ELECTRO MOTIVE MFG. CO., Inc.
Willimantic, Connecticut

MANUFACTURERS ARE INVITED
TO SEND FOR SAMPLES

MOLDED MICA

El-Menco
CAPACITORS

MICA TRIMMER

FOREIGN RADIO AND ELECTRONIC MANUFACTURERS COMMUNICATE DIRECT WITH OUR EXPORT DEPT. AT WILLIMANTIC, CONN. FOR INFORMATION.
ARCO ELECTRONICS, INC. 103 Lafayette St., New York, N. Y.—Sole Agent for Jobbers and Distributors in U. S. and Canada

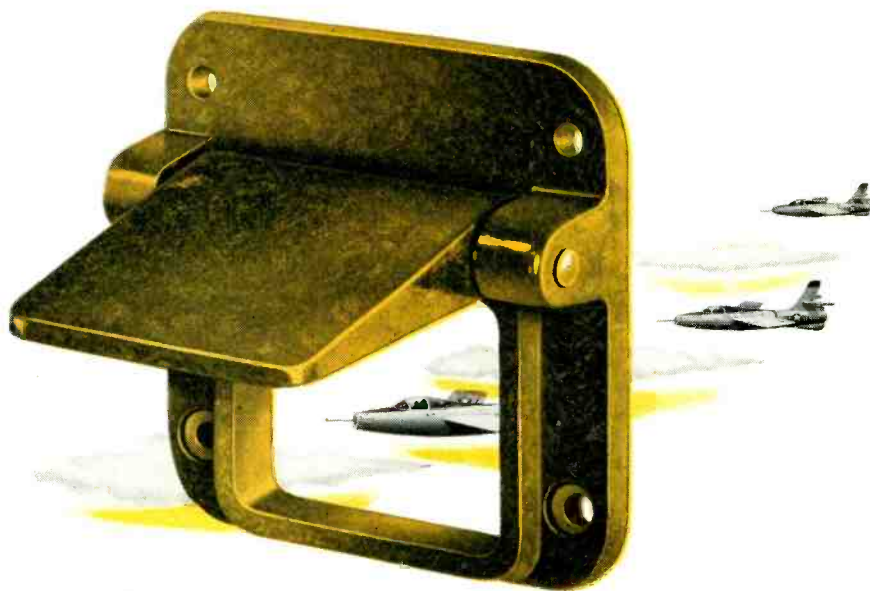

How to discipline fuel—in flight

It takes more than an experienced pilot and well engineered control surfaces to keep an airplane in straight and level flight.

Fuel must be delivered to the engine without fail. The fuel must be controlled—prevented from sloshing from one cell to another or from end to end of the cells.

That's where the little flapper valve, manufactured for the B. F. Goodrich Company, comes in. Placed in fuel cell baffles, and opening inboard, these devices keep the fuel in place despite any changes in flight attitude, permit the fuel to flow only in the proper direction.

They must be positive in operation. The material from which they are made must be inert in the presence of "loaded" aviation fuels, dimensionally stable, non-absorptive, light in weight . . . and, for reasons of economy, be easy to manufacture.

All these requirements add up to a call for Synthane molded-macerated plastics. But there is much more to the story. Synthane has a wide and rare *combination* of chemical, mechanical and electrical characteristics which make it a material for almost all industry.

It is hard, dense, exceptionally strong for its weight. Synthane is an excellent electrical insulator, has low dielectric constant and low power factor. It is economically produced in molded forms of moderately complex shapes. Parts may be quickly machined from Synthane sheets, rods or tubes on standard equipment. It is moisture and corrosion resistant, and is *thermo-setting*.

These few of Synthane's many advantages may suggest its value to you. If you would know more about Synthane, send for the Synthane Catalog. Synthane Corporation, 6 River Road, Oaks, Pennsylvania.

PLASTICS WHERE PLASTICS BELONG

SYNTHANE
Oaks **S** Pennsylvania

When you need a FUSE—think of BUSS

THE MOST COMPLETE LINE OF FUSES FOR THE *Electronic Industries*

- RADIO
- TELEVISION
- RADAR
- INSTRUMENTS
- CONTROLS
- AVIONICS

Whatever your needs in electrical protection there's a Buss fuse made to fit.

Send for Bulletin SFB—showing full line of fuses and fuse mountings.

SPECIAL FUSES, FUSE CLIPS, FUSE BLOCKS and FUSE HOLDERS

Sometimes a special fuse or fuse mounting is required. In such cases we welcome your requests either to quote—or to help in designing or selecting the special type of fuse or fuse mounting best suited to your particular conditions.

Submit description or sketch, showing type of fuse to be used, number of circuits, type of terminal, etc. If your protection problem is still in the engineering state, tell us current, voltage, load characteristics, etc.

At any time our staff of fuse engineers is at your service to help solve your problems in electrical protection.

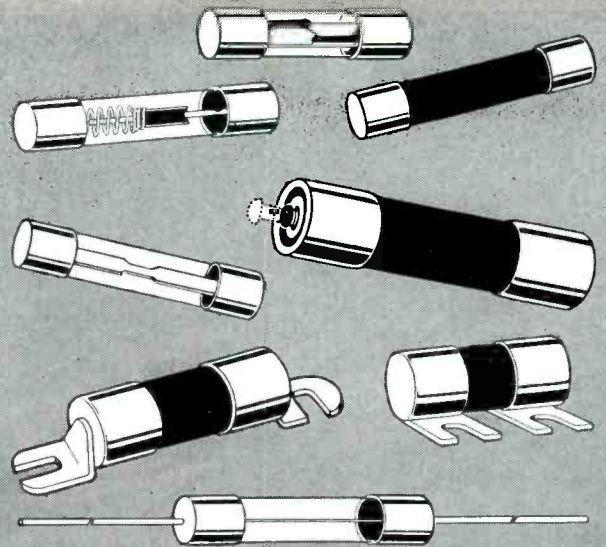

A complete line of fuses made to dimensions smaller than National Electrical Code fuses.

These fuses are SPACE SAVERS.

They are particularly well suited to the protection of instruments, radios, television and electronic equipment of all kinds, aircraft, automobiles, coin-operated devices and any apparatus where space for the protective device is at a premium.

Fuses of the Dual-Element, Renewable and One-Time type are available.

Companion lines for FUSETRON and BUSS small dimension fuses are BUSS Fuse Clips, Blocks and Fuse Holders. They are made in many types and sizes to make it easy to select the fuse and fuse-mounting needed to give the required protection.

For full information ask for the BUSS Bulletin on Small Dimension Fuses and Fuse Holders — Form SFB.

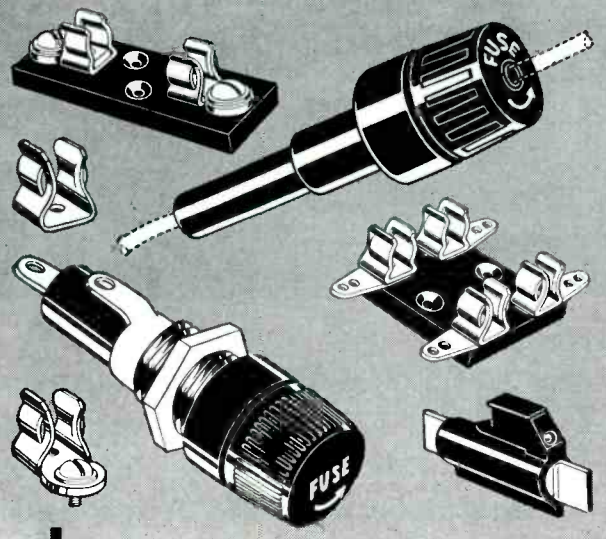

USE THIS COUPON — *Get all the facts*

Bussmann Mfg. Co., University at Jefferson
St. Louis 7, Mo. (Division McGraw Electric Co.)

Please send me Bulletin SFB containing complete facts on Buss Small Dimension Fuses.

Name _____

Title _____

Company _____

Address _____

City _____ State _____

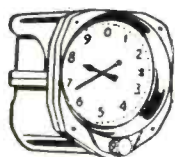
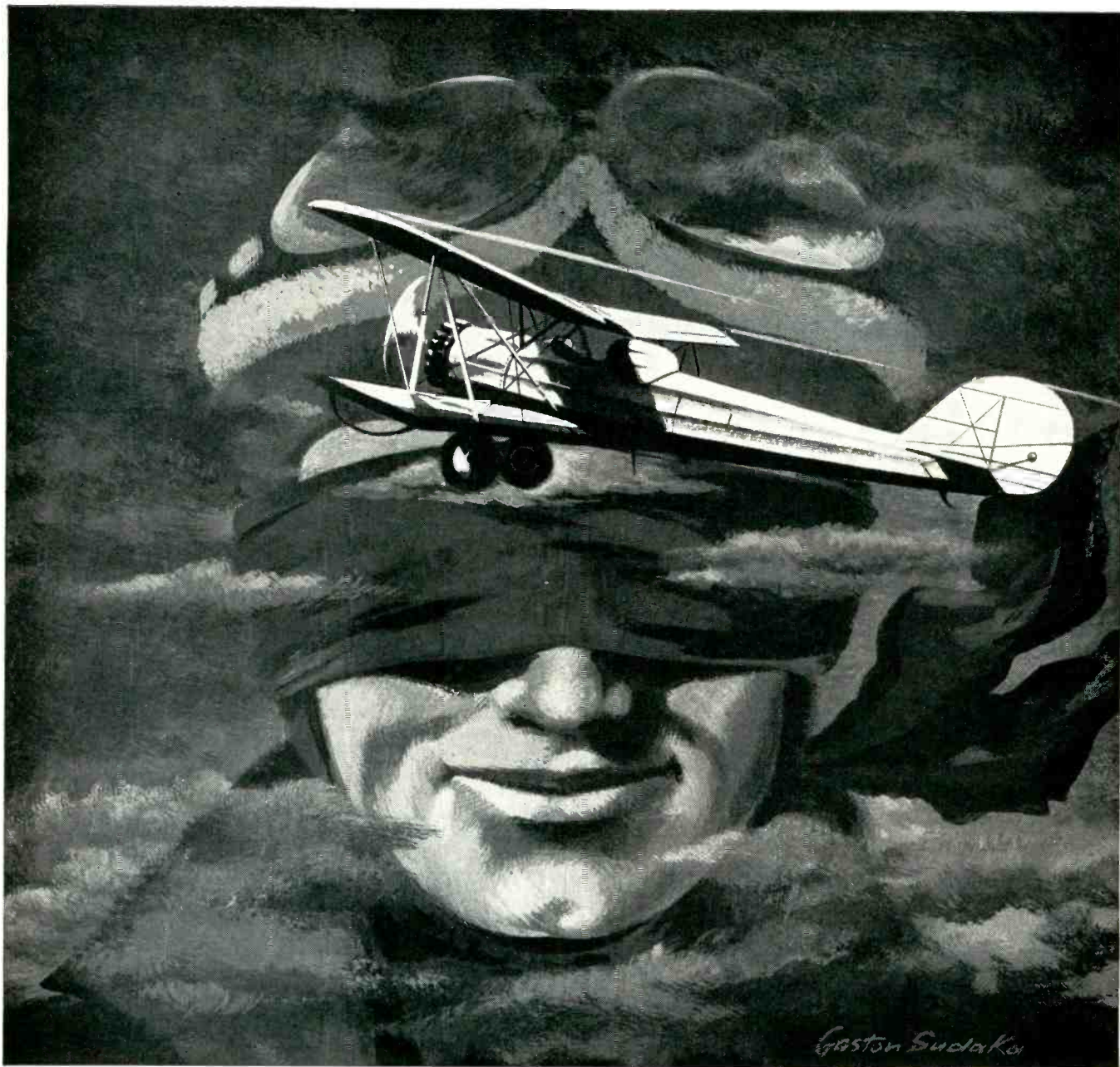

“In” at the start... Since that “eye-popping” day of aviation’s first successful blind flight, Kollsman has specialized in the making of precise, dependable instruments. ✦ In the evolution of modern flight, Kollsman was literally “in” at the start. For a Kollsman Sensitive Altimeter made accurate instrument flying more than a laboratory “pipe-dream.” ✦ And later—to pace the needs of aviation science—Kollsman developed a series of complex miniature motors—units to expertly control involved systems of instrumentation. ✦ Today, these high-precision, steady-working Kollsman motors give new meaning to accuracy and control in countless numbers of applications.

for precision and dependability

look to **KOLLSMAN**

INSTRUMENT CORPORATION

Elmhurst, New York • Glendale, California

ASK *Erie* RESISTOR



... about custom designed trimmers

Pictured above are several custom designed trimmers that incorporate the elements of standard Erie Disc and Tubular Ceramicon Trimmers. Each has been developed for a specific purpose, and each does its job efficiently and economically. Proper design and precision manufacturing, plus our years of experience, are the keynote to Erie quality.

Look at these units carefully. They should suggest the possibility of using Erie Resistor know-how and facilities to make your equipment more compact and more efficient.

Erie has the most complete trimmer line in the industry. We would like to work with you on combining trimmers, fixed capacitors, and other circuit elements into integrated sub-assemblies. Inquiries should specify complete mechanical and electrical requirements.

- ① Standard Style TD2A Dual Trimmer with mounting pillars.
- ② Special ribbon type terminals on standard Style TS2B Trimmer for direct connection to other components.
- ③ Compact Trimmer—Capacitor—Resistor—Coil Design. A complete oscillator unit.
- ④ Where special mounting is desired, standard Erie Style TS2A and Style 557 Trimmers can be supplied mounted on brackets.
- ⑤
- ⑥
- ⑦ Two trimmer elements become an integral part of this coil form and I. F. top section,
- ⑧
- ⑨ Special bracket and terminal arrangements on dual trimmer unit.
- ⑩ A compact pluggable assembly for mounting a trimmer in parallel with a plug-in crystal.
- ⑪ Special tubular ceramic trimmer and variable inductance having one common terminal.
- ⑫ Special steatite tubular dual trimmer.
- ⑬ Standard Erie Style 557 Trimmer with special bent rotor terminal.

Electronics Division

ERIE RESISTOR CORP., ERIE, PA.

LONDON, ENGLAND . . . TORONTO, CANADA





Interoffice Correspondence

To: Assembly Division
From: President's Office

Dear Jim:

I've just been checking over quarterly records. I see unbelievable reduction in cord set rejections. Hope you are maintaining our standard of quality, and that these figures are right. Please double check.

Ed

*Dear Ed- Figures are OK.
 Quality is actually better.
 Answer simple - we
 changed to Belden Cords.
 Jim*

1. Low Installation Cost
2. Low Inspection Cost
3. Fewer Rejects
4. Less Returned Goods
5. Less Failures in Service
6. Satisfied Customers

WRITE: Belden Manufacturing Co.
 4625 West Van Buren Street
 Chicago 44, Illinois

CORDITIS-FREE CORDS BY...

Belden

WIREMAKER FOR INDUSTRY

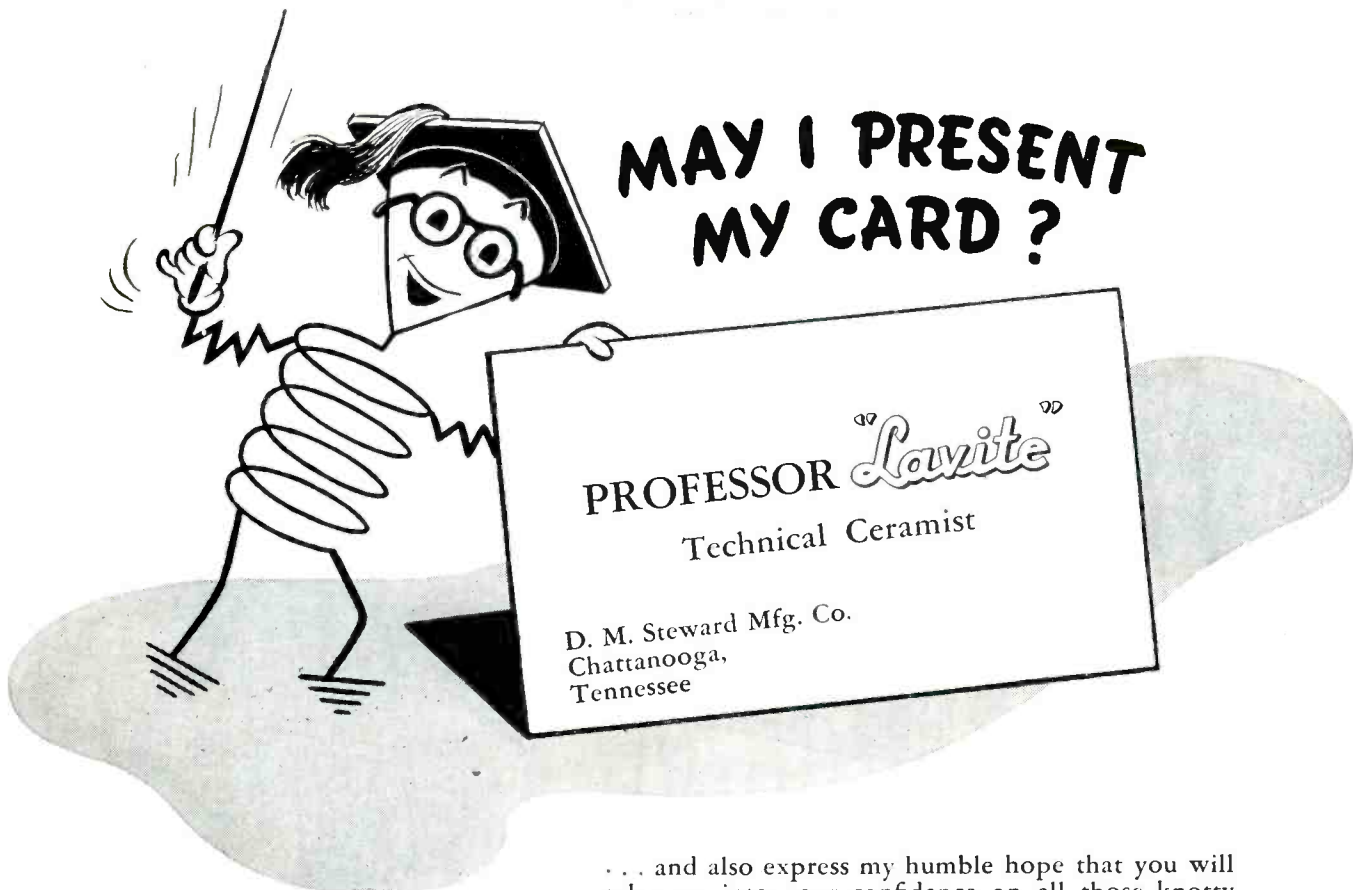

MAY I PRESENT MY CARD ?

PROFESSOR *Lavite*
 Technical Ceramist

D. M. Steward Mfg. Co.
 Chattanooga,
 Tennessee

... and also express my humble hope that you will take me into your confidence on all those knotty problems involving technical ceramics. You see, "Lavite" is more than just my name—it is the name by which the wide selection of Steward Technical Ceramics ("Lavite" Steatites, "Lavite" Titanates, "Lavite" Ferrites and many others) have become widely known. In fact, I am truly flattered to know that "Lavite" has become the name and standard that many of the most exacting users of technical ceramics insist on and specify religiously. "Lavite" Ceramics are not new developments—in fact, they have been in research and redevelopment for 75 years. "Lavite" Ceramics offer you practically any desired combination, or balance, of physical properties to satisfy your needs—from ordinary radio and general medium-frequency applications to those demanding precise qualities of low electrical loss, high mechanical strength and thermal shock resistance, plus the advantages of excellent machineability which permits production of your ceramic parts to closest tolerances.



Ask for your copy of our booklet, "Lavite" Technical Ceramics, Table of Properties. (Steatites, Titanates, Ferrites and others.)

Send me your specifications for practical and proved recommendations, or ask for a testing sample of any one of this famous family of technical ceramics without obligation.

D. M. STEWARD MANUFACTURING CO.
 3604 Jerrome Avenue Chattanooga, Tennessee
Sales Offices in Principal Cities



RURAL transformer & equipment co.

SINGLE STEP, LINE TYPE

VOLTAGE REGULATOR LEADS

ARE INSULATED AND PROTECTED WITH

NATVAR 400

EXTRUDED VINYL-BASE TUBING

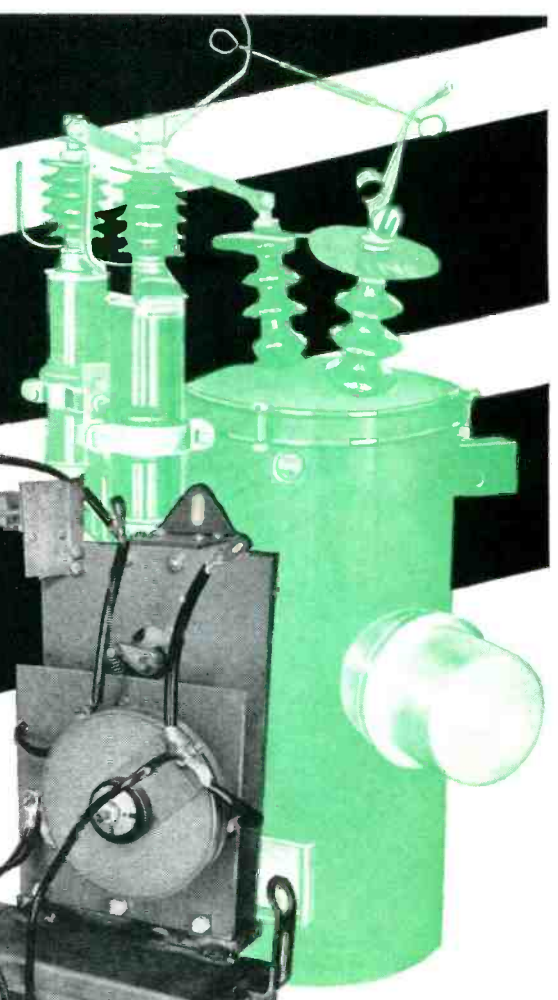

Newest addition to the Ruralformer line is this low cost pole mounted Type 1R Voltage Regulator. It helps save line copper and reduces customer complaints by automatically furnishing a 3.75% boost when required. This inside tank view shows core and coil assembly and the resistor side of the main switching assembly. All leads are insulated and protected with Natvar 400 extruded vinyl-base tubing.

The Rural Transformer & Equipment Co., Milwaukee, manufactures distribution transformers and associated equipment. They have developed a low cost, high surge strength transformer for distribution of rural power at 14,000 volts. With externally operated tap changer, bonded coils, and externally mounted protection against lightning surges and overload, Ruralformers carry a strong service guarantee.

Component parts and materials have been carefully picked. Natvar 400 extruded vinyl-base tubing is used to insulate and protect leads because of its consistently superior resistance to both oil and heat.

It will pay you to use Natvar 400 tubing, tape, and other Natvar flexible insulating materials for your requirements. They are available either from your wholesaler's stock or direct from our own.



Natvar Products

- Varnished cambric—straight cut and bias
- Varnished cable tape
- Varnished canvas
- Varnished duck
- Varnished silk
- Varnished special rayon
- Varnished Fiberglas cloth
- Silicone coated Fiberglas
- Varnished papers
- Slo⁺ insulation
- Varnished tubings and sleeveings
- Varnished identification markers
- Lacquered tubings and sleeveings
- Extruded vinyl tubing and tape
- Extruded vinyl identification markers

Ask for Catalog No. 21

THE NATIONAL VARNISHED PRODUCTS Corporation

Telephone
Rahway 7-8800

Cable Address
NATVAR: Rahway, N. J.

201 RANDOLPH AVENUE ★ WOODBRIDGE, NEW JERSEY

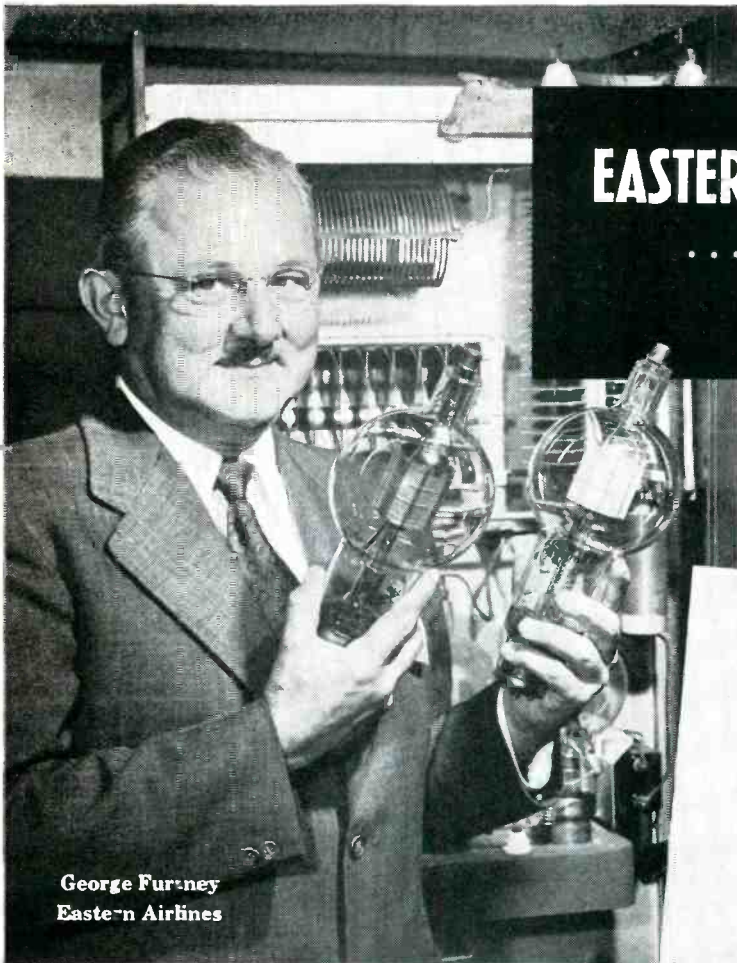

George Furtney
Eastern Airlines

EASTERN AIR LINES

... famous for dependability ...

says this about Eimac tubes.

The statement by George Furtney of Eastern Air Lines once more proves that the work-horses of modern commercial communication systems are the Eimac 450T type triodes. Their dependability is unchallenged.

The 450T is rated at 450 watts plate dissipation, 6000 max. plate volts, and 600 ma. max. plate current at frequencies as high as 40 Mc. They are widely used as either amplifiers, oscillators, or modulators. Complete data and application notes will be furnished upon request.

The 450T type triodes and other outstanding Eimac vacuum tubes are today specified in ever increasing numbers to fill key sockets in important military, communications, and industrial equipments. Consider them for your equipment . . . they have been proved in service . . . an unbiased proof that is your assurance of undeniable dependability.

Eitel-McCullough, Inc.
San Bruno, California

Export Agents: Frazer & Hansen, 301 Clay St., San Francisco, California



GWP:fd
Attachments

THERE'S NO SUBSTITUTE FOR EASTERN'S EXPERIENCE

*A new Eimac quick-reference
catalogue is now available.*

Write for yours.

Follow the Leaders to

Eimac
TUBES

290

Button, Button, who's got the Button (Capacitors that is...)?

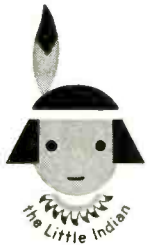

THE LITTLE INDIAN SAYS.

Sangamo can furnish SILVERED MICA BUTTON CAPACITORS for any requirement...

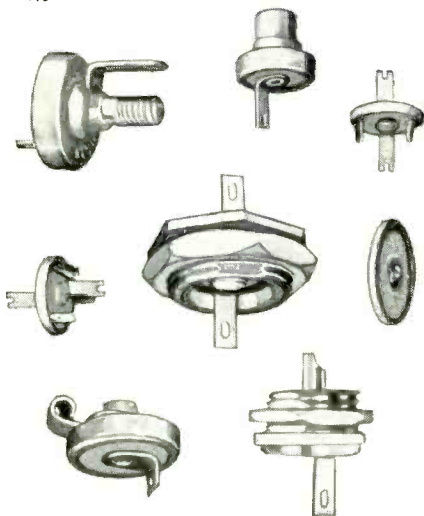

You can look to Sangamo whenever you need small sized, light weight button capacitors, with extremely low series inductance, for application in high frequency circuits. Sangamo Button Capacitors are encased in silver plated, corrosion resistant brass and are exceptionally stable over a wide temperature range. The case is utilized as the low potential terminal.

Sangamo Silvered Mica Button Capacitors meet all requirements of V.H.F. and U.H.F. applications. They can be furnished with temperature coefficients and drift characteristics up to and including "E" of Armed Services specification JAN-C-5. The normal operating temperature range is from minus 50° C. to plus 85° C. Higher operating temperature requirements will be considered and may be negotiated with The Sangamo Capacitor Engineering Department. Catalog No. 830 gives full details—write for your copy.

Your Assurance of

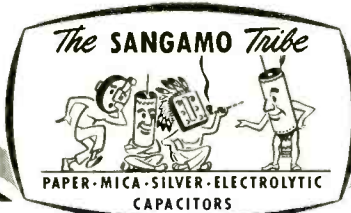

Dependable Performance

SANGAMO ELECTRIC COMPANY

SPRINGFIELD, ILLINOIS

IN CANADA: SANGAMO COMPANY LIMITED, LEASIDE, ONTARIO

EC31-7

FOR READY REFERENCE...

A Complete List of



Welded GERMANIUM DIODES

ALL of the General Electric diode products listed below have the following advantages over other types of rectifiers commonly used: welded contact... low shunt capacity... insulating case... small

physical size... long life... no filaments... no contact potential... self-healing... high moisture resistance. Complete bulletins sent on request. Write: *General Electric Co., Sec. 471, Electronics Park, Syracuse, N. Y.*



CATEGORY	RTMA DESIGNATION	G-E TYPE	PEAK INVERSE VOLTAGE	CONTIN. OPER. INV. VOLTAGE	MIN. FORWARD CURRENT (MA) AT +1V	MAX. INV. CURRENT (@) AT -50V	AV RECTIFIED CURRENT (MA)	PEAK RECTIFIED CURRENT (MA)	SURGE CURRENT (MA)	SIZE
GENERAL PURPOSE	1N48	G5	85	70	4.0	833	50	150	400	A
	1N51	G5C	50	40	2.5	1667	25	100	300	A
	1N52	G5D	85	70	4.0	150	50	150	400	A
	1N63	G5E	125	100	4.0	50	50	150	400	A
	1N75	G5M	125	100	2.5	50	50	150	400	A
TV	1N64	G5F	20	Min. dc current in 44 mc rectifier—100 @ a				150	400	A
	1N65	G5G	85	70	2.5	200	50			A
JAN	1N69	G5K	75	60	5.0	850	40	125	400	A
	1N70	G5L	125	100	3.0	410	30	90	350	A
VHF		G6	15	Min. Rect. Eff. at 100 mc and 2 v signal—60%						A
UHF	1N72	G7	5	}	+3db max. noise factor over 1N21B in 500 mc mixer CKT	25	75			B
		G7A				25	75	A		
		G7B				25	75	B		
		G7C				25	75	A		
		G7D	5	}	75% min. rec. eff. at 100 mc for detector	25	75	B		
		G7E				25	75	A		
		G7F	5	}	Tested for sharpness of break E-I char. for freq. multiplier	25	75	B		
		G7G				25	75	A		
MATCHED PAIRS Note (1)		G8	85	70	4.0	833	50	150	400	A
		G8A	85	70	4.0	150	50	150	400	A
		G8B	125	100	4.0	50	50	150	400	A
		G8C	125	100	2.5	50	50	150	400	A
QUADS	1N73	G9	75		Note (2)	50 @ -10v	22.5	60	100	D
	1N74	G9A	75		Note (3)	50 @ -10v	22.5	60	100	D
TRANSISTORS Note (4)		G11	} Max. RMS emitter signal level—.3v; max. DC emitter current—.5 ma;							C
		G11A	} Max. DC collector current—2.0 ma; power gain 17 to 21 db; power output 25 mw							C

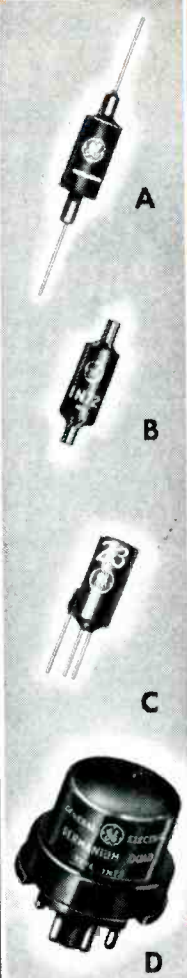

- (1) Matched at +1v so that current through higher resistance unit is within 10% of lower resistance unit.
- (2) Consists of 4 balanced diodes. With 15 ma forward current; the voltage drop of each diode is 1.3v min. and 1.7v max., all diodes are within 0.1 volt of each other, and voltage drop of a pair is 0.03 volts of each other.

- (3) Consists of 4 balanced diodes. With 15 ma forward current; the voltage drop of each diode is 1.2v min. and 1.8v max., all diodes are within 0.2v of each other, and voltage drop of a pair is 0.1v of each other.
- (4) Additional test over G11 for negative resistance of base current vs. base voltage characteristic for trigger circuit operation.

You can put your confidence in—

GENERAL ELECTRIC



new!



PYRAMID TINY TYPE 85LPT TUBULAR PAPER CAPACITORS

Fit anywhere!

**Suitable for
85°C. operation!**

CAPACITANCE RANGE:
.0001 TO .5 MFD.

VOLTAGE RANGE:
200 TO 600 V., INCLUSIVE

**Sturdily built in phenolic-
impregnated tubes. Ends
are plastic-sealed.**

WRITE FOR COMPLETE LITERATURE
Representatives and Distributors
Throughout the U.S.A. and Canada



PYRAMID

PYRAMID ELECTRIC COMPANY

1445 Hudson Boulevard

North Bergen, N. J., U. S. A.

TELEGRAMS: WUX North Bergen, N. J.
CABLE ADDRESS: Pyramidusa

BUSINESS BRIEFS

By W. W. MacDONALD

Washington's Attitude during the last war appears to us to have been "take care of the assemblers of complete equipment and they will take care of the component makers." It has been quite a while developing, but this time we think we see signs that it will be "keep component makers in business during the unsettled period and let assemblers paddle at least part of their own canoe."

Some time will elapse before this new thinking is translated into action that all component makers can feel. Action seems, however, to be definitely on its way.

Another Trend we see developing in the nation's capital is a long-overdue shift from the "study and statistics" phase of the mobilization effort into the "action even if every possible contingency cannot be foreseen" stage. Personnel changes within several government agencies are partially responsible for the trend. In particular, association of more men from our industry with government agencies, on a part-time or full-time basis, is responsible.

Most Important Date for our industry is July 1, when the Controlled Materials Plan goes into effect.

CMP is designed to insure adequate supplies of critical materials for essential defense and defense-supporting projects. It leaves manufacturers of nonessential civilian items out in the cold to scramble for any materials that are left over. The pickings may be lean, or they may be lush.

Just what CMP will do to civilian equipment production cannot be evaluated in advance because the situation is quite different from that during World War II. Then, production facilities were heavily engaged on military equipment and no one worried much about civilian equipment production. Now, production facil-

ities are only partially devoted to military equipment and civilian equipment production is important in the economy, particularly the production of television sets.

Several government officials to whom we talked in Washington just before press time thought there might be enough materials available in the open market for the balance of the year to support a healthy civilian business, particularly if the use of noncritical substitutes expanded. Others thought it might eventually be necessary to bring certain materials required for the production of civilian goods under CMP.

Munitions Board is currently inviting responsible electronic-equipment manufacturers and their technical personnel to look at gear recently designed and built for the Air Force and the Navy. Such gear is being exhibited, despite the fact that it is classified, in certain major cities with the hope that by examining it new government contracts will be more acceptably executed.

We looked over the equipment recently exhibited in New York, and while identification cannot be made without violating security regulations, we can tell you that some of the construction, components and materials opened our eyes. If you have an opportunity to look over the equipment, by all means do so.

Elmer's Law is the one which says that if you are measuring a d-c voltage the initial arrangement of your voltmeter leads will be wrongly polarized.

Scientific Instrument Makers are unhappy about a recent tariff cut on certain imported apparatus. They point out that our government had to scramble for such apparatus when the supply was cut off from abroad during the last war and that an American industry virtually had to be started

Put Electronics to work IN YOUR HOME!

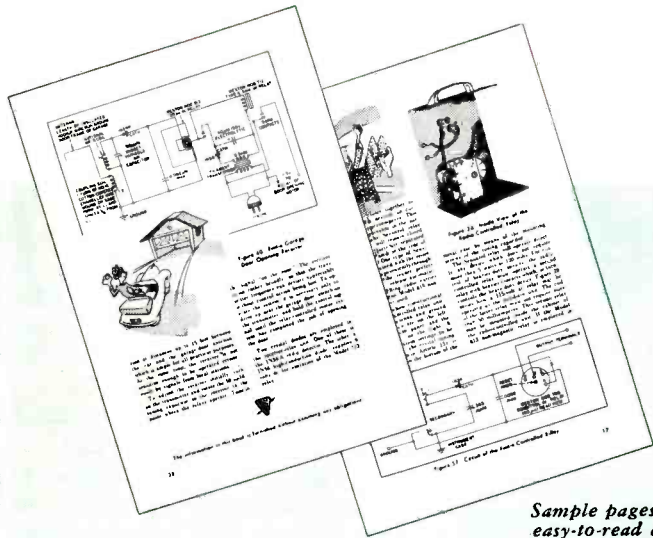

Sample pages showing easy-to-read diagrams.

HERE'S HOW TO MAKE 24 VALUABLE TIME- AND LABOR-SAVERS

You don't have to be an electronics engineer to build these useful household gadgets. The step-by-step instructions in Sylvania's fascinating new book, "Electronic Shortcuts for Hobbyists," are written expressly for the home hobbyist, model maker and electrical experimenter. With this book you can build:

- A Radio-Controlled Door Opener.
- An Electronic Door Lock.
- A Charger for Small Dry Batteries.
- Radio-Controlled Relays.
- Pocket-Sized Stroboscopes.
- Remote Control for Model Trains.
- A Doorbell Booster.
- Photoelectric Relays.
- Photographic Interval Timers.
- An efficient Crystal Radio . . . and many other valuable gadgets.

All you need is some inexpensive Sylvania Crystal Diodes and a few everyday materials. Book contains full instructions and easy-to-follow diagrams. Send a quarter along with the coupon for your copy.



24 SIMPLIFIED APPLICATIONS
FOR THE HOME HOBBYIST,
EXPERIMENTER AND
MODEL MAKER

SYLVANIA ELECTRIC PRODUCTS INC.

ONLY **25¢**

Sylvania Electric Products Inc.
Dept. E-1007, Emporium, Pa.

Enclosed please find my 25¢ for copy of
"Electronic Shortcuts for Hobbyists."

Name _____
Street _____
City _____ Zone _____ State _____



SYLVANIA ELECTRIC

ELECTRONIC DEVICES; RADIO TUBES; TELEVISION PICTURE TUBES; ELECTRONIC TEST EQUIPMENT; FLUORESCENT TUBES, FIXTURES, SIGN TUBING, WIRING DEVICES; LIGHT BULBS; PHOTOLAMPS; TELEVISION SETS

SHOCK and VIBRATION NEWS

BUSINESS BRIEFS

(continued)

BARRYMOUNTS FOR ASSURED CONTROL OF SHOCK AND VIBRATION

SMALL AIR-DAMPED BARRYMOUNTS for Miniaturized Airborne Equipment

New-series Barrymounts, designed to meet requirements for compact isolators usable with miniaturized equipment, provide effective shock and vibration isolation in small space.

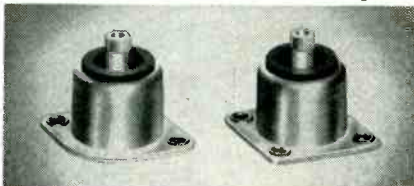

These mountings utilize air damping to minimize shock of aircraft landing and taxiing and to limit excursion so there is no snubber contact, even at resonance.



Upright and inverted types are available for two-hole or four-hole mounting. Unit mountings are one inch in diameter and 1-1/32 inches high under maximum rated load. Load ratings are 0.1 to 3.0 pounds per mount. The mountings weigh only 5/16 ounce each.

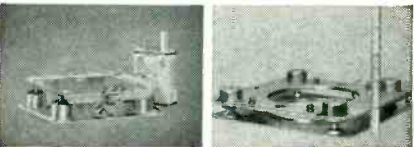

Bases using the inverted mountings raise the mounted equipment only 1/2 inch. Either upright or inverted unit mountings can be furnished on bases that conform to your specifications, load-ratings, and dimensions.

FREE CATALOGS

- 502 — Air-damped Barrymounts for aircraft service; also mounting bases and instrument mountings.
- 509 — ALL-METL Barrymounts and mounting bases for unusual airborne applications.
- 605-606 — Miniaturized air-damped Barrymounts for use with airborne equipment.

STANDARD MOUNTINGS ISOLATE VIBRATION Available for Aircraft, Marine, Mobile, Instrument, and Industrial uses.



Standard bases built to meet government specifications can be furnished by Barry; special bases can be supplied in sizes and load ratings to fit customers' exact requirements, including miniaturized bases. See catalog 502 and data sheets 605 and 606.

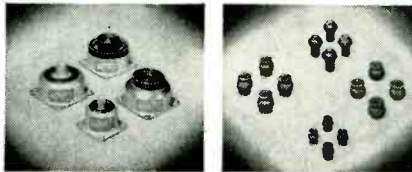

Aircraft vibration isolators designed to meet Army, Navy, and CAA requirements are available in 1/4-pound to 45-pound unit ratings; also miniature mounts to 0.1 lb. See catalogs 502 and 509 and bulletins 605-6.

Instrument mountings are furnished for electronic components, tiny, fractional-HP motors, record changers, dictating machines, and other light-weight apparatus. See catalogs 502 and 504.

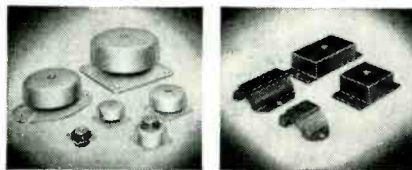

Shock mountings for mobile, railroad, and shipboard service also give vibration isolation at frequencies above 2000 c.p.m.; useful for general sound isolation. See catalog 504.

Industrial mountings isolate vibration from fans, motor-generator sets, transformers, punch presses, and other heavy industrial equipment. Bulletin 607 tells how to cut maintenance costs with Barrymounts.

from scratch. Now, they say, there is some danger that that industry may dwindle away. The other side of the picture is the desirability of supporting friendly European countries by supplying a market for their goods.

Here's another case in which it appears necessary for our government, faced by a half-war and half-peace situation that is unique in its history, to at least temporarily try to carry water on both shoulders.

Direct Quote much to the point is this one from a talk by GE's W. R. G. Baker before the Foreman's Association at Electronics Park:

"The real cost of mobilization must be paid by workers and . . . concerns engaged in production of civilian goods and services. The fewer persons and concerns producing civilian goods and services the less money there will be to finance military production."

Four War Years 1942 through 1945 saw our industry delivering 1,500,000 radio sets and 20,000 radar sets to the military.

Production of radio sets in the first quarter of this year totalled 4,235,597 and there were 2,199,669 television receivers made, according to RTMA. This represents increases of 27 and 37 percent over the first quarter of 1950. It is pointed out, however, that preliminary second quarter reports indicate a decline as against last year.

Some 95 percent of the tv sets made in the first quarter used picture tubes 16 inches or larger in diameter.

TV Receiver Inventory as of May 1 is estimated as between 1,750,000 and 1,850,000 sets by Television-Electronics Fund, Inc. of Chicago. This, according to the source, represents about three to three and a half months supply based on average monthly sales for the preceding 12 months.

TV Chassis intended for custom building into special cabinets or home recesses were bought by 90,-

THE **BARRY** CORP.

707 PLEASANT ST., WATERTOWN 72, MASSACHUSETTS

SALES REPRESENTATIVES IN

New York Rochester Philadelphia Washington Cleveland Dayton Detroit

Chicago Minneapolis St. Louis Seattle Los Angeles Dallas Toronto

000 people in 1950, according to an estimate by John H. Cashman of Radio Craftsmen. Retail value of the chassis is estimated at \$10,000,000.

Government Purchases of radio transmitting and communications equipment during 1950 totalled \$116,477,892, according to RTMA. \$92,297,971 of the total was for radar. Purchases during 1949 totalled \$141,288,869.

North American Aviation says the present goal in automatic airplane guidance is a flight control system capable of directing an interceptor airplane through an entire combat mission. Takeoff, climb-out, target pursuit and destruction, and return to base would be accomplished automatically, with the human pilot merely selecting the target and monitoring the mission.

Once Before (p 60, Aug. 1950) we commented on the interest of horse players in electronic equipment. One of them had, we noted, used radio to send race results out of a park before said results reached the horse parlors, and so bet on sure things until dissuaded by the gendarmes.

Now the bookies are harnessing our art. One of them was picked up just the other day for interconnecting three successive telephones located at different places around New York City through automatic relays, making it difficult for the police to wiretap or raid.

Philco has 2,000 electronics field engineers serving with the armed forces all over the world.

This Month's Masterpiece of understatement: Electronics industry official, showing great restraint when discussing a government-proposed change in broadcasting equipment operating procedure, said . . .

"We agreed to try the suggestion in conversations at Washington, and at Washington there wasn't much trouble involved. However, the nearer we approached the site of the work the more interesting the problem became."

SANBORN 1, 2 and 4 channel RECORDING SYSTEMS

DIRECT WRITING • NO INK
RECTANGULAR COORDINATES
PERMANENT RECORDS

RECORDERS AND AMPLIFIERS
AVAILABLE SEPARATELY

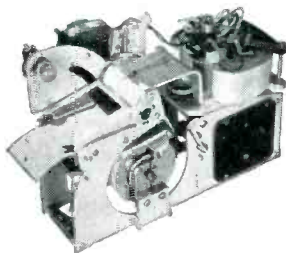

In all Sanborn recorders, tracings are produced by a heated writing stylus in contact with heat sensitive, plastic-coated paper. The paper is pulled over a sharp edge in the paper drive mechanism, and the stylus wipes along this edge as it swings; thus producing records in true rectangular coordinates. The writing arm is driven by a D'Arsonval moving coil galvanometer with extremely high torque movement (200,000 dyne cm/cm deflection). Standard paper speed for the Model 51-600 recorder assembly, shown above, is 25 mm/sec. Slower speeds are available. Paper width 6 cm with 5 cm recording area. The assembly shown above is used in Models 128 and 141 (described above right) and provides the basic principles and methods on which recorders for the 2- and 4-channel systems are designed.

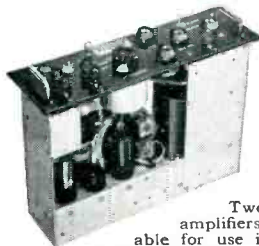

Two types of amplifiers are available for use in Sanborn recording systems—a DC General Purpose Amplifier, and a Strain Gage amplifier (shown above). The amplifiers used in the 2- and 4-channel systems are generally identical with those in the 1-channel system, which are available, are also all the recorders, for separate application.



For complete descriptions, illustrations, tables of constants, and prices, write for catalog.

1 CHANNEL RECORDING SYSTEMS

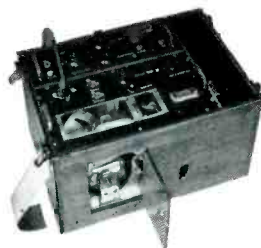

Model 128 comprises a DC General Purpose Amplifier in combination with the Recorder Assembly shown below left, to which is added panel, transformer, and controls. Both instruments are contained in a single hardwood carrying case. The complete system is a vacuum tube recording voltmeter capable of reproducing in rectangular coordinates any electrical phenomena from the order of a few millivolts to more than 200 volts. When a Strain Gage Amplifier is specified, the system becomes Model 141. Amplifiers are readily interchangeable. When a built-in timer is included for either, the Model numbers become 128T or 141T.

2 CHANNEL RECORDING SYSTEMS



The two channels of **Model 60** operate independently of each other, but record simultaneously. Ten paper speeds are standard equipment, in pairs of: 5 and 0.5, 10 and 1, 25 and 2.5, 50 and 5, 100 and 10 mm/sec. Ready interchangeability of amplifiers (DC and Strain Gage) and preamplifiers (DC and AC) makes possible the availability of a variety of input circuits. Timing and coding are built-in features. Each channel has a 5 cm recording width.

4 CHANNEL RECORDING SYSTEMS



Model 67 provides for the direct, simultaneous registration of up to four phenomena on one record, using the same principles and methods as the two systems described above. In addition, there is a selection of eight paper speeds: 50, 25, 10, 5, 2.5, 1.0, 0.5, and 0.25 mm/sec., and provision for the use of 4-, 2-, or 1-channel recording Permapaper. As in Model 60, above, amplifiers and preamplifiers are readily interchangeable.

INDUSTRIAL DIVISION

Sanborn Company

CAMBRIDGE 39, MASSACHUSETTS

**Value
Beyond
Expectation!**

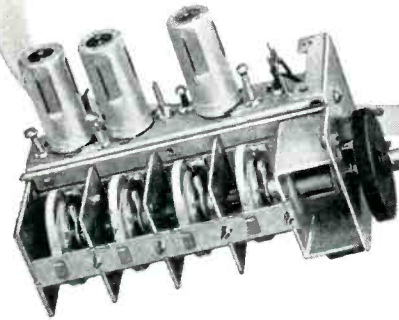

Restrict Oscillator Radiation with the Mallory TV Teletuner*

The development of a TV front end assembly which avoids interference with other electronic equipment is a recent and far-reaching accomplishment of Mallory research and engineering.

Built around the four-tuned-circuit Spiral Inductuner, this new front end is designed and constructed to limit radiation from the oscillator. Further precaution is taken by shielding the oscillator and converter from the RF amplifier. And, each section of the Inductuner is individually shielded. Thus, Mallory offers TV manufacturers a complete front end capable of performing within strict standards for oscillator radiation.

That's value beyond expectation!

The Mallory Teletuner is universally adaptable. It features higher gain and lower noise figure. It is available in 3, 4 and 6 revolution designs, incorporating the characteristics of the Spiral Inductuner listed at the left. Complete technical data sheets are available on request.

Outstanding Advantages of the new Mallory Spiral Inductuner**

1. A single control for easy selection and fine tuning of any television or FM channel.
2. Easily adapted to UHF converter use.
3. Excellent stability eliminates frequency drift.
4. Supplied in two-, three-, or four-section designs.
5. Far more quiet operation; permits lower noise figures in front end designs.
6. Free from microphonics.
7. Greater selectivity on high frequency channels.
8. Eliminates "bunching" of high band channels.
9. Simplifies front end design and production.
10. Reduces assembly costs.
11. Choice of: 6 turn unit continuously tunes from channels 2 to 13; 4 turn unit tunes only channels 2 to 6, FM, 7 to 13; 3 turn unit tunes only the 12 television channels.

*Trademark.
**Reg. trademark of P. R. Mallory & Co., Inc.
for inductance tuning devices covered by
Mallory-Ware patents.

Television Tuners, Special Switches, Controls and Resistors

SERVING INDUSTRY WITH

Electromechanical Products
Resistors Switches
TV Tuners Vibrators

Electrochemical Products
Capacitors Rectifiers
Mercury Dry Batteries

Metallurgical Products
Contacts Special Metals
Welding Materials

P. R. MALLORY & CO. Inc.

MALLORY

P. R. MALLORY & CO., Inc., INDIANAPOLIS 6, INDIANA



CROSS TALK

► **PICKUP** . . . Last year about this time we irked our American friends in tv broadcasting somewhat by reporting that British tv stations do a conspicuously better job of televising film than we do, despite the fact that the British video band is 1.25 mc narrower than the American. Some of those who doubted the report have since been to London to see for themselves and have confirmed the superior quality of British film transmissions. The explanation, one of the reasons advanced in favor of the European scanning standard of 25 frames per second, is the fact that flying-spot scanning can be used, with this standard, merely by running the film about 4 percent faster than normal. With the American standard of 30 frames per second this is not feasible, so we use storage-type cameras, notably the iconoscope, to perform the transfer from 24 film frames to 30 scanning frames per second.

Sporadically reports have appeared that a new scanner was in process of development that would overcome the impasse and permit flying-spot scanning of film on the American standard. Such a film scanner was, in fact, shown to the SMPTE a few weeks ago by the Bell Telephone Labs (p 114, this issue). The new device uses two clever electronic servos to overcome vertical jitter and flicker, and pro-

duces a picture that is very, very good—better than anything on the air today anywhere. For various reasons, Ma Bell does not intend to produce the scanner commercially, but is willing to license others to do so. Our guess is that, when the development is complete, several large corporations will be competing for the privilege.

► **SECOND CHANCE** . . . In view of the great importance of education in our field, we note with pleasure the establishment of the Majestic Research Fund, Inc. which will provide 48 “second-chance” scholarships per year, valued at about \$2,000 each, to persons over 35 years of age who were unable to secure or complete their formal education in earlier years. The fund of \$500,000 was set up by Majestic Radio and will be administered by a board of officials of NYU, Columbia, Brooklyn Polytech, and the Textile Workers of America. A worthy project, and one which can be copied by other companies without fear of committing infringement.

The growing realization of industry's stake in higher education was voiced recently by Alfred P. Sloan, Chairman of General Motors, at a dinner signaling his gift of \$5 million to found a school of industrial management at MIT. Mr. Sloan pointed out that it is becom-

ing impossible to operate colleges and universities by the investment of endowment funds, and that no relief from this difficulty is in sight. He suggests that industry at large ought to set up a foundation to make outright grants to such institutions, for education and research, without expecting direct monetary return, the funds to be liquidated over periods as short as five years. Continuing support of a given research project would then depend on actual results and potential value. The big foundations and many individual companies are already doing this, but the base has to be very broad to support a program as big as this country needs.

► **ODE** . . . As we write, the Supreme Court has just rendered its opinion on the color television case of RCA vs FCC. Also, within a few days we take our departure for Geneva, for the Sixth Plenary Session of the C.C.I.R. So, all in all, we think it safe to print the following ditty, which is not original with us or Rudyard Kipling:

The filters and dichroics die,

The mirrors and the disks depart

Still stands our basic raster type
And readings on the testing chart.

Dear FCC, be with us yet,

May we forget, may we forget!

Production Planning

The six post-war years have seen per-man-hour production of electronic equipment more than double, at the Sperry Gyroscope Company, despite increased complexity of products and an increase in the unskilled-to-skilled operator ratio. Details of production planning program that made this increase possible are presented

PRODUCTION of electronic equipment reached an all-time high during World War II. Some of the methods used to attain these high production figures were of necessity inefficient, but they were nevertheless effective. One fortunate aspect of the present state of affairs is the fact that industry today has an opportunity to plan ahead. While there is no *certainty* of another global conflict, there is a *threat*, and by laying careful plans now, the occurrence of such a disaster can be met with methods that are efficient, as well as effective.

At the Sperry Gyroscope Company, production per man hour of military electronic equipment has more than doubled since the end of the war. This is on an average basis—in some instances increases of 8 and 10 have been realized. This statement is even more impressive than it appears at first because of the increased complexity of the equipment being turned out today. Also adding to the impressiveness is the fact that production progress is being accomplished with the use of less-skilled help. The end products, again as a result of planning and specialization, are of better quality. Quality improvement was,

in fact, the motivating influence that started the program that made the increases possible.

The Sperry System

Many of the new ideas that enable a company of Sperry's size to increase production come about through paper work and the shuffling of personnel both on the management side and in the shop.

Key to the system is the letter-sized operations sheet. These sheets break each job down into step-by-step functions. Descriptions of these various functions are in plain language, written so that operators even in the lowest skill categories can understand them and carry out the prescribed operations.

The use of such sheets offers many advantages:

(1) Because of the great detail used on operations sheets, in contrast to that which could be placed on a blueprint without undue complication, greater quality and uniformity of products is obtainable.

(2) An operator who has used one sheet can follow similar sheets almost without further instruction, which relieves shop foremen for other duties. This also enables the production department to run one job for a time and then to switch



FIG. 1—Setup for cutting uniform wire lengths. Shear jaws are actuated when wire end comes in contact with switch



FIG. 2—Old method of removing shields involved snipping with shears. New methods are shown in Fig. 3 and 4

to another without lost motion.

(3) Fewer mistakes are likely to occur when an operator has only to follow a description of his particular job, rather than an over-all blueprint. In fact, little knowledge of blueprints is required—instructions are in words and sketches.

(4) The sheets, being of small and uniform size, are readily filed and easily available for reference—the unfolding of monstrous blueprints is always time consuming and distracting to others.

(5) If production on a particular

• DURING WORLD WAR II, approximately 40 man hours were required at Sperry for turning out a particular amplifier chassis, and the average skill classification was B.

• Today, as a result of production planning and technological advancement, the same amplifier chassis is completed in 6 man hours, and the average skill is D. (Skill D is one step above trainee!)

Speeds Military Orders



FIG. 3—Production shield-removing operation. At left, operator forms pyramid from shield. Co-worker removes pyramid with nibbling machine so that shield end falls free

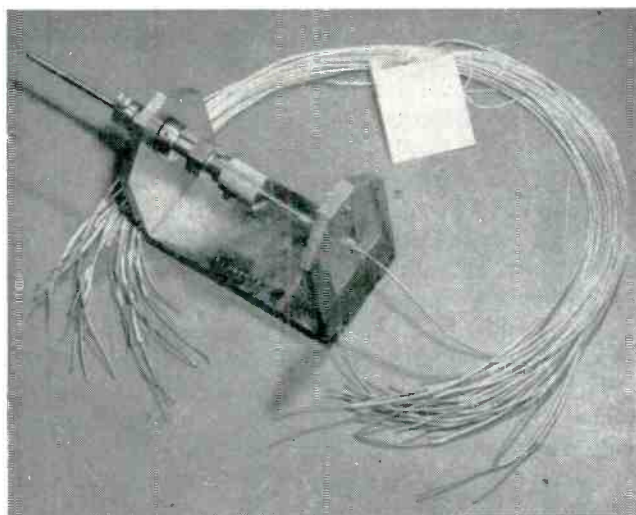

FIG. 4—New shield remover involves one simple operation. Use of this tool is explained in text. Note wire tag containing instructions attached to bundle



FIG. 5—During World War II, harness making became an important adjunct to equipment fabrication. This photograph shows a typical installation from that period

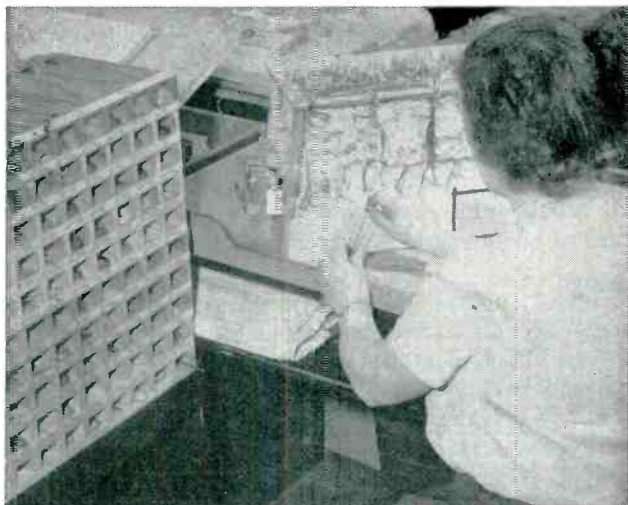

FIG. 6—Since the war, Sperry has developed and adopted the wire-rack shown at extreme left for holding wires in proper sequence of use in harness

job must be stepped up, the operations sheets may be further subdivided so that each worker does only half of the steps, thereby speeding the operation without additional training and indoctrination. Extra workers are simply sandwiched in between the regulars and given their share of the operations.

Each job has its operations sheets. In fact, at Sperry, as many as 175 different varieties of products may be turned out in a single month. In the accompanying illustrations, it will be noticed that

most of the workers have their operations sheets conveniently located for quick reference—unless their jobs are of a nature where reference is unnecessary.

Production Procedure

The wire preparation department at Sperry provides a good example of recent improvements. Looking back, the day is not too far gone when a chassis was wired by a skilled technician armed with a coil of wire, a pair of needle-nosed pliers and a soldering iron. His

knowledge had to include complete familiarity with schematic diagrams, or drawings, and experience with soldering, identifying components and contact numbers, cabling and lacing, and it was desirable that he appreciate the importance of lead dress and circuit functions.

That type of operation more or less disappeared in the last war, but significant improvements have been made even in the past five years.

Today all wires are prepared in bundles prior to assembly. A small

tag is the start of each bundle. On receipt of instructions from the production department, a shop worker refers to a list of wires that will be needed for a given job. A tag is then made out for each wire in the job. This tag tells the wire preparation department all it has to know to prepare the bundle. Length, type of insulation, gage of wire and end preparation details are included. Special instructions are given to shielded wires, telling what length of outer insulation is to be removed, where the shielding is to be cut, whether or not a ground wire for the shield is required, and so on.

The completed tags then follow each wire bundle through cutting, stripping, tinning and any other operations, so that the worker at each operation can abstract his instructions without reference to anything but the tag. Tags are visible in many of the accompanying photographs. Similar orders simultaneously go to all other production departments, with the result that necessary components converge on the assembly area at just the right time. Small parts are parcelled into convenient stack bins and numbered in sequence in the order of their use in the particular job.

Finally, appropriate operations sheets are dispatched among employees. Each employee goes to the appropriate departmental storage area, withdraws his necessary equipment, and production begins without delay.

Wire Preparation Details

When a tag is issued for a batch of wires, it first goes to the cutting department. Small sizes are then cut to length and stripped on conventional Artos automatic wire-preparation machines. Special lots are allocated to either hand operations, or special machines of the type shown in Fig. 1. This why-didn't-I-think-of-that idea is typical of aids that can drastically cut down on production time and increase efficiency. It consists simply of a pair of pneumatically-operated cutting jaws, a yardstick, and a snap-action switch which slides along the yardstick. The heavy wire, which cannot be processed by

the Artos machines, is pulled from a coil through the cutting jaws until its end comes in physical contact with an improvised target that is fixed to the snap-action switch. At that instant, the jaws cut the wire to the desired length. A pointer on the yardstick permits adjustment for different lengths.

From the cutting operation, the smaller wires go to the twisting and tinning operation. Several other time-saving operations are applied at this step, where larger wires—especially shielded cable—are processed.

Figures 2, 3 and 4 show the old and two new ways for removing outer shielding. The old way, and this method is now in use at many plants, involved an operator using a pair of shears to remove the prescribed amount of shielding. The first of the new systems (Fig. 3) consists of two processes, each handled by separate operators. The first is referred to as pyramiding. The operator grasps the shield with two pairs of V-shaped jaws. He then bunches the shielding by pushing the jaws toward each other, with the result that a pyramid-shaped flange of shielding forms around the wire. The wire, thus prepared, is then passed to the next operation, which is known as nibbling. Here a pair of flush cutting surfaces nibble away at the raised portion of the shield as the operator turns the wire. Then the shield between the end of the wire and the removed pyramid drops free.

The second shield remover is a recent addition, and is still undergoing evaluation. The operation is much simpler and faster. The tool is shown in Fig. 4. A hardened steel tube, attached to a universal joint, passes through a circular inside cutting surface. The tube's inside diameter is sufficient to accept the insulated inner wire, while the shielding fits over the tube. It is relatively simple to push the wire onto the tube in this fashion. After inserting the wire, the tube is moved circularly around the inside cutting surface of the tool. The blade shears the shield in several motions and leaves the shield conveniently flared for insertion of a ferrule. The steel

tube is held in place by a chuck to facilitate rapid changes for different wire sizes. A graduated rod in the tube measures the amount of shielding to be removed.

Most marking is done as a matter of manufacturing convenience, though some jobs call for marked leads for certain terminal board connections where marking facilitates service in the field. Commercial markers may be used, or small pieces of premarked tubing fitted over the ends of the wires. In the latter case, a slight bend in the end of the wire will hold on a piece of rigid tubing until the lead is soldered in and the marker removed.

It was found in using commercial marking machines that a conventional typewriter ribbon would serve well as a source of ink, if the imprints were subjected to a drying process. An ordinary 200-watt infrared lamp shining on a boxfull of pieces of tubing does the job of drying thoroughly and quickly.

Conventional automatic and manually operated lug and ferrule machines insure good connections to wires at their terminations.

Harness-Making Hints

The value of prefabricating wire harnesses for complicated chassis has long been known. Harness boards save countless hours in production time. By prewiring multiconnection plugs before the harnessing operation, even more time is saved. Dugouts must be provided to accept the plugs in the proper plane. Figures 5 and 6 show typical old and new harness-making locations at Sperry. The job, shown in Fig. 6, involves a three-dimensional harness with plugs brought out at right angles to one of the planes. Cotter pins hold wire ends in place, while simple nails secure eyelets. Numbers at the ends of each wire enable the worker to proceed on a job, working from his operations sheet, with no experience on a particular model, but with certainty that what is done is right.

The wire rack at the left in Fig. 6 is a development that has generously rewarded its inventors. The wires are placed in the rack in advance, and in the order in which they are to be added to the harness,



FIG. 7—All plugs are prewired at locations such as these. Note convenient position of operations sheet for quick reference



FIG. 8—Subassembly location shows block of stack bins, soldering-iron holder, rubber flap over a-c outlet and tool drawers

starting at the upper left and working down as one reads a page of written text. Each wire is precut to exact lengths and properly processed for the particular job. The wire racks are built of basic building-block rows of ten pigeon-holes that may be placed on top of one another and in back of one another to accommodate more wires or longer wires.

Figure 7 shows a typical plug-wiring station. Universal fixtures, used throughout the plant, and completely adjustable, hold one or several plugs. Notice the operator has her operations sheet at her left and the wire rack conveniently located. A spring fixed over the jig holds wires out of the way after they have been soldered in place.

Subassembly Prefabrication

Figure 8 shows a typical subassembly location. The stack bins are, as might be expected, all pre-filled with the specified number and types of components, all placed in order of use, corresponding to the operations sheet for that job. The tool in the hand of the operator on the left is a wiping tool which bends the wire around lugs on terminal boards. The cradle type fixture permits rapid changes in position of subassembly.

The soldering-iron stand shown in the background has several convenient features. The iron may either be inserted from the back, as shown, for work requiring two

hands, or from the front for removal and application to fixed assemblies. A specially-treated pad in front of the iron makes it easy for the operator to keep his iron clean, with resulting improvement in soldered joints. The chest of drawers under the table is provided for the employees' tools and personal effects. The use of these relatively simple facilities greatly reduces cluttering of the working area with cosmetics, cigarette packages and so on. A clip-on rubber protector over the 110-volt outlet under the bench prevents down time as a result of loose wire ends shorting out power lines and eliminates certain human hazards.

The leads of all small parts are preformed, prior to assembly, on special machines designed for that purpose. When a resistor arrives at the assembly area, it has already been trimmed and bent to conform to the points between which it is to be soldered. Short bus pieces are also thus preformed.

Inspection locations are dispersed through the plant so that rejects take the form of small subassemblies instead of completed units.

The plant is at present in the process of installing swinging ash trays that may be moved out of sight under the bench when not in use. This reduces the possibility of ashes getting into work, and adds generally to the appearance and efficiency of the shop.

Soldering irons are assigned to

each individual operator. Simple hand tools are his personal property; these are made available at cost to him through the plant tool room. This scheme introduces an actual improvement in work through pride of personal ownership.

It was found that ten minutes of production time was wasted at the end of each shift because the operators pulled their plugs to let their soldering irons cool for storage. This waste was eliminated by providing asbestos scabbards for the irons, which allowed them to be disconnected at quitting time and stored while still hot. Soldering iron tips are maintained by a special crew. Special partly-chromium-plated tips are used.

Future Planning

The basic operations outlined are, for the most part, typical of the things that make increased production efficiency possible. They are mostly simple things, brought about by cooperation and understanding and a will to turn out good work efficiently. Their incorporation was not a matter of chance, but the result of a five-year study of methods and facilities.

Carried through other assembly operations, the same kind of planning that has facilitated wiring is making it possible for less-skilled production workers, backed up by experienced foremen working with a highly skilled group of production engineers, to do a better job.—J.D.F.

Horizontally-Polarized

Provides azimuth ratio less than 3 db for frequency range of 2,970 to 3,125 mc with good voltage standing-wave ratio. Vertical pattern has half-power points at 45 degrees, which gives antenna a gain of approximately 2 db over half-wave dipole

By **CHARLES BRASSE, JR.**
and
RICHARD THOMAS

*Bendix Radio Division
Bendix Aviation Corp.
Baltimore, Maryland*

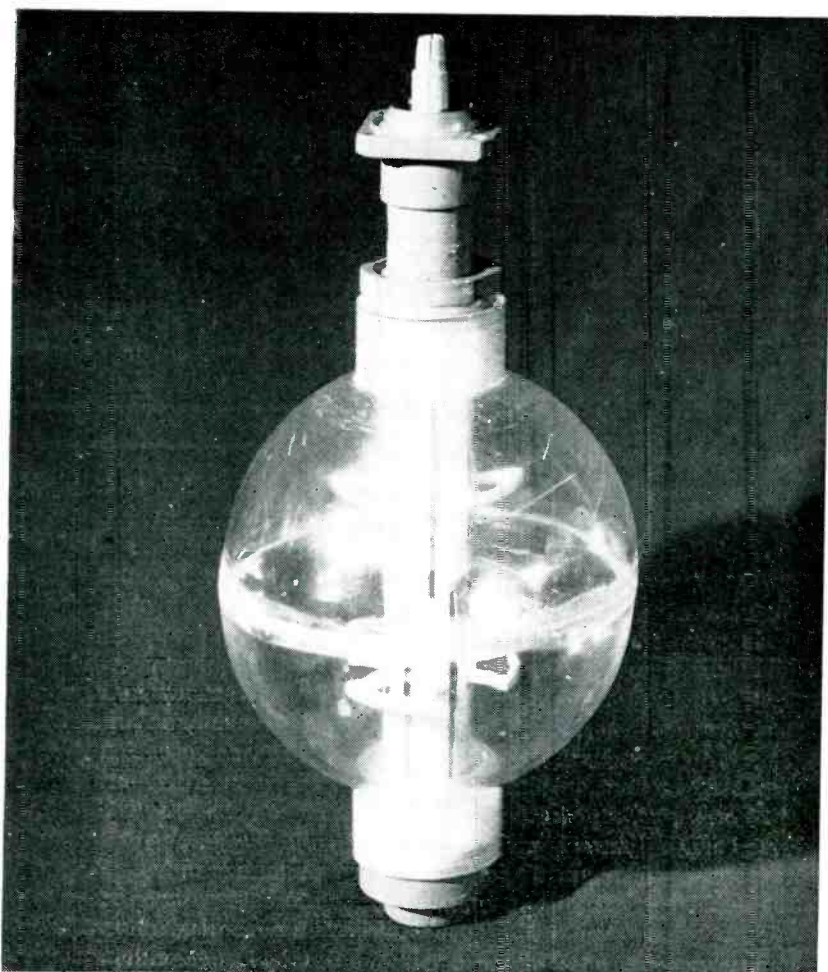

Horizontally-polarized omnidirectional antenna for 10-cm region mounts directly on rigid $\frac{7}{8}$ -inch coax. Plexiglas ball permits pressurizing antenna

THE ANTENNA described herein was designed for use in the 10-centimeter band, and the particular application for which it was intended required that the azimuth ratio be less than 1.5 db at the center of the band.

To achieve a perfectly omnidirectional pattern in the horizontal plane, with the polarization in this plane, the ideal radiating element should consist of a ring of uniform current. In practice, this type of current distribution may be approximated by means of a number of dipoles, slots, or loops arranged in a circular fashion and equally phased. All three types were considered in connection with the manner in which the elements could be mounted on a $\frac{7}{8}$ -inch rigid coaxial line, for convenience of manufacture, and it was decided that best results would be obtained through the use of loops as radiators.

Constructional Details

A very rugged feed system for loops can be easily built on the $\frac{7}{8}$ -inch line by inserting an even number of radial rods equally spaced about the periphery of the coax, alternate rods passing through to the center conductor. Loops are then formed by joining the ends of pairs of adjacent rods, as shown in Fig. 1A, where three loops are arranged on six rods.

This model was constructed by

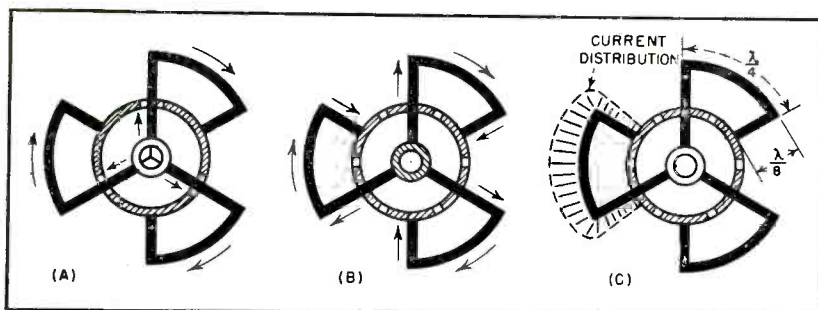

FIG. 1—Configurations shown at B and C are improvements of that shown at A. Addition of balun slots improves electrical and mechanical characteristics

Omnidirectional Antenna

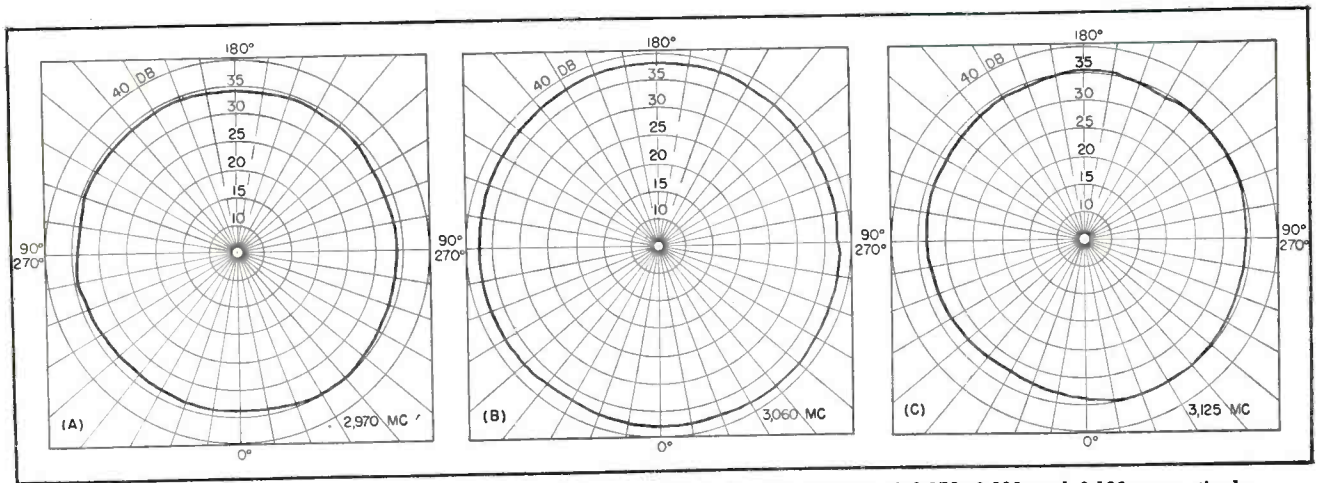

FIG. 3—Azimuth patterns show azimuth ratios of 1.25, 1 and 3 db for frequencies of 2,970, 3,060 and 3,125 respectively

using screws for rods, the ones joining the inner conductor passing through clearance holes in the outer conductor. This feed system can be improved mechanically and electrically by the use of slots as baluns and impedance-matching elements. Figure 2 shows a side view of this configuration, and Fig. 1B shows how the slots permit the proper polarities to be established. In this

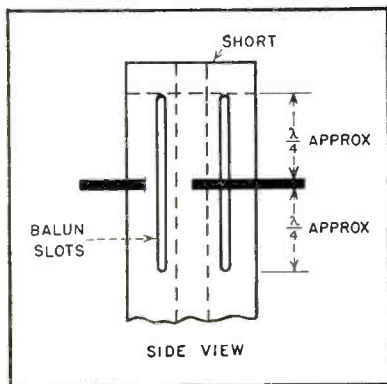

FIG. 2—Side view of configuration giving best results

model, the screws entering the inner conductor are also soldered to the outer conductor, thus forming a rigid support for the entire assembly.

The dimensions of the loops and the resulting current distribution are given in Fig. 1C from which it can be seen that the current is at a relatively high level at the rod ends. Dipoles could be used, but they would have to be longer, and the

antenna would not be as mechanically rigid as the quarter-wave loops.

It would of course be possible to use the slots alone as radiating elements, by suitable probe feeding. In this case, however, the depth of the probes is somewhat critical and involves a tedious procedure of adjustment, especially if it is desired to stack two or more sets of elements to increase directivity in the vertical plane. By the use of loops, tuning is easily accomplished by increasing the length of the slots, which should be initially cut slightly less than a half wavelength.

A given set of loops will in general present an impedance which has low resistance and a capacitive reactance, and the negative shunt susceptance contributed by the slots will serve to match the antenna to the line with a minimum vswr of about 1.5. Increasing the loop perimeter will lower its apparent resistance and will produce a greater departure from a circular azimuth pattern, due to the shift of current distribution along the loops.

The photograph shows a two-stack array which was enclosed in a hollow Plexiglas ball as a simple means of pressurizing the antenna. The upper loops are located $\frac{1}{4}$ wavelength below the shorted end of the coax, and the lower loops, with feed reversed to obtain proper phasing,

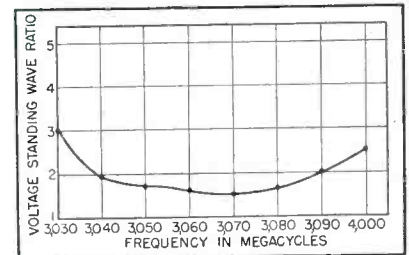

FIG. 4—Curve shows vswr for frequency range. No effort was made to extend range by broadbanding techniques

are spaced $\frac{1}{2}$ wavelength below the upper set. The vertical pattern has a half-power beamwidth of 45 degrees, equivalent to a gain of approximately 2 db over a half-wave dipole. Figure 3 shows azimuth patterns taken at 2,970, 3,060 and 3,125 megacycles respectively, and the corresponding azimuth ratios are seen to be 1.25, 1 and 3 db. These patterns were taken on the Bendix automatic pattern-measuring equipment which provides a continuous recording covering a field strength range of 50 db, and incorporates facilities for self calibration in order to insure accuracy at all times.

The vswr characteristics of this antenna are shown in Fig. 4.

Only three loops were required for each element, and the resulting antenna combines satisfactory electrical performance together with mechanical simplicity, ruggedness and ease of adjustment.

Community CIVIL DEFENSE

Onondaga County, N. Y., which embraces the city of Syracuse, is setting up a system which utilizes the existing two-way radio facilities of 13 commercial and civic services, plus amateurs, and expects to have it in fully-coordinated operation by mid-August

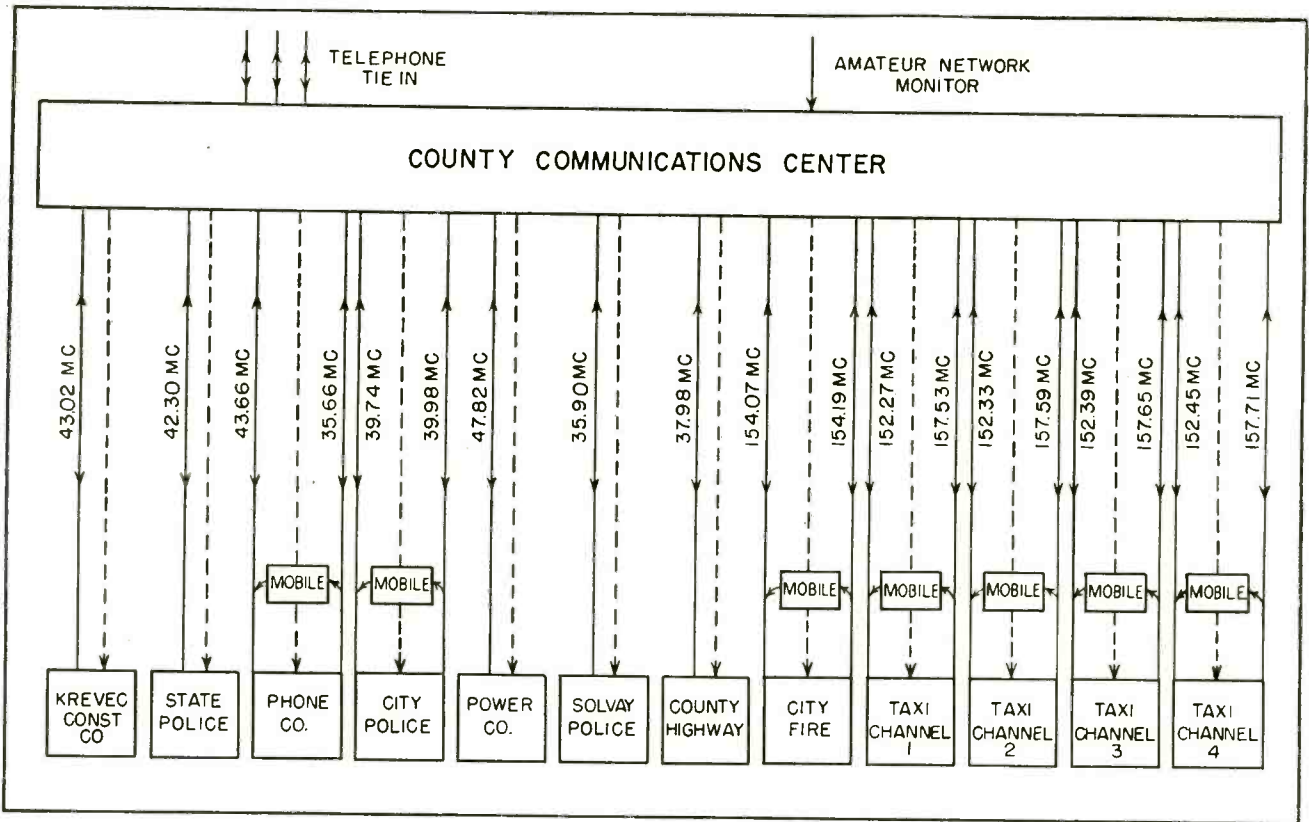

FIG. 2—Civil-defense system set up to make fullest use of available facilities and to provide an emergency backstop for them in the event of damage by sabotage or bombing. Dashed lines show paths of county-communications-center coordinating transmissions. Taxi-channel 1 is used by two independent companies

By **NEAL F. HARMON**

*Civil Defense Coordinator
Electronics Department
General Electric Company
Electronics Park
Syracuse, N. Y.*

CIVIL DEFENSE authorities of Onondaga County, N. Y., including the city of Syracuse, are building a close-knit emergency communications system which will soon be ready for operation. The system will be flexible to the extent that it can supplement present communications in the area when needed, or take over for all present facilities in the event they are sabotaged or damaged in bombing attacks. It

DEPARTMENT		PROFESSION	NUMBER OF	NUMBER OF	NUMBER OF	NUMBER OF	NUMBER OF
			RADIO	STATION	STATION	STATION	STATION
			OPERATED	TYPE	TYPE	TYPE	TYPE
Police, City of							
Police, City of							
Police, County of							
Fire, City of							
Fire, City of							
Fire, County of							
Public Utility (Gas, Electric, Water, Gas, etc.)							
Taxi Companies							
Other Department							
State Police							
Telephone Companies							
Marine Service							

Designated Coordinating Frequency _____ now being used for
 Communication Coordinator _____
 Address _____
 Name _____

FIG. 1—Form used to determine two-way commercial radio facilities already available in Onondaga County

adds new radio facilities which can be used in peace as well as war emergencies.

Basically, the Onondaga County system revolves around a communications center equipped to (1) coordinate all existing commercial and civic two-way radio facilities in the area, (2) act as a standby system for any or all of these facilities if they are damaged in an emergency and (3) tie into other methods of communication such as the public telephone system and an amateur radio network.

Setting Up the System

Using the form in Fig. 1, a survey was made of local two-way

COMMUNICATIONS Plan

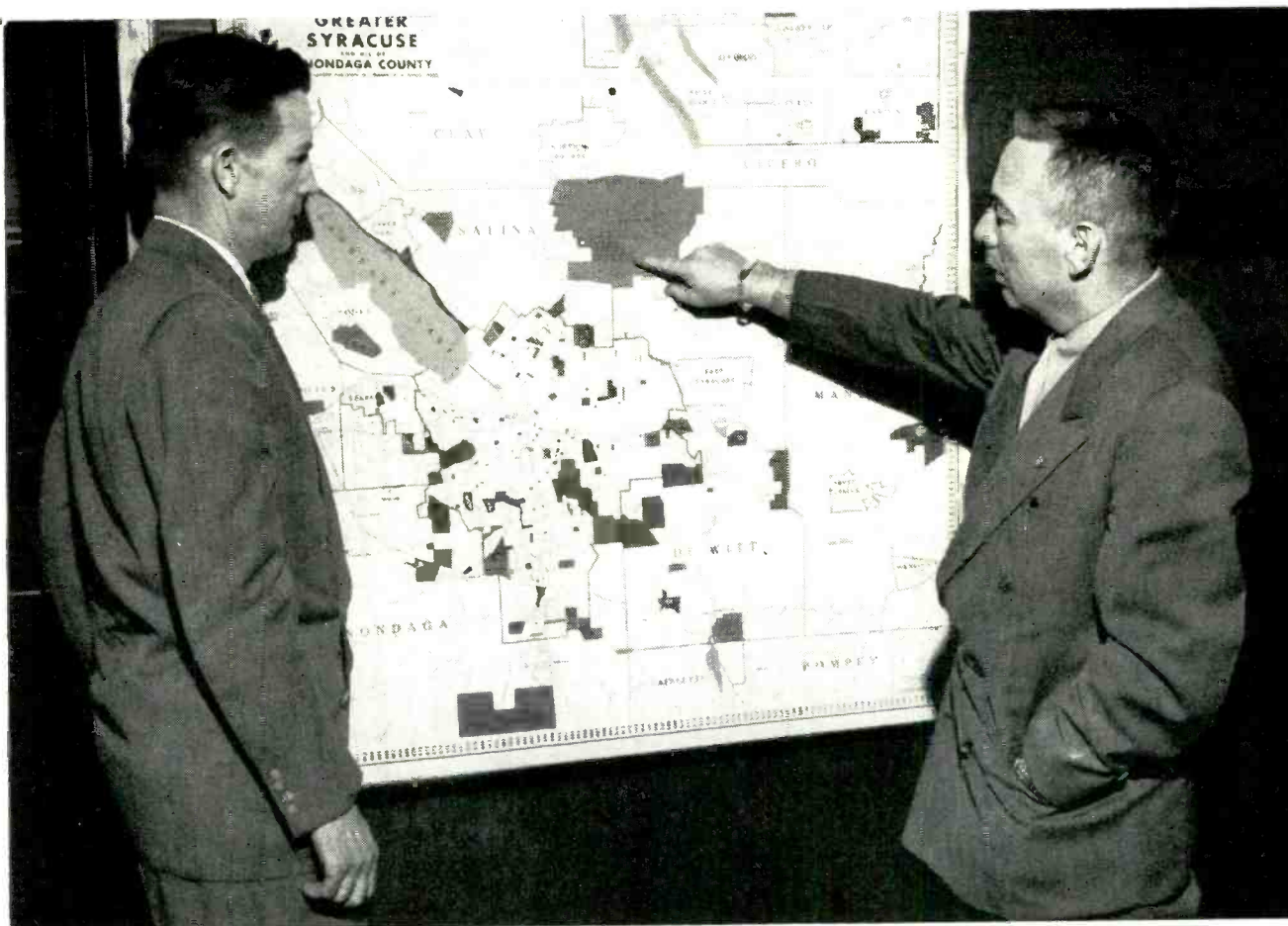

Author Harmon (left) looks over map of Greater Syracuse area preliminary to survey of civil-defense-communications requirements by local officials, with Harvey S. Smith, Onondaga County Civil Defense Director, at right

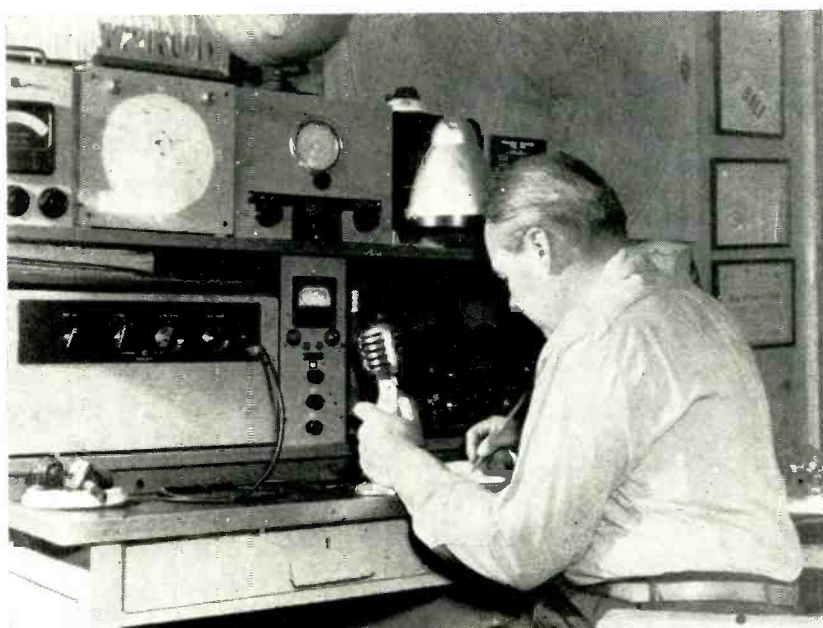

AMATEURS are tied into the system and their network monitored from the county communications center



POLICE provide an important part of the facilities

radio systems. Any community could utilize the same form to accumulate maximum information on available facilities. Using information recorded on the form a chart, Fig. 2, was made to pictorially present the entire system.

The survey revealed 13 services operating on 19 frequencies. These are the New York State Police, Syracuse Police, Village of Solvay Police, Syracuse Fire Department, Onondaga County Highway Department, telephone company mobile telephone subscribers, electric power company, a construction company, and five taxicab companies utilizing four frequencies. The County Sheriff's department shares the facilities and frequencies of the Syracuse Police Department. Seven of the services employ two-frequency operation,

with mobile units transmitting on a different frequency than the main-station transmitter. The 13 services operate more than 400 mobile units throughout the county.

Communications Center

Civil defense authorities will maintain only supervisory control over the various services unless forced to take over for them because of loss of equipment, power or personnel. This means the CD center must be able to operate (1) as a mobile unit on any of the service frequencies, (2) as an auxiliary fixed station for any or all of the services should the need arise and (3) as a station from which to supervise and coordinate the entire system.

To do this, the center will be equipped with transmitters and re-

ceivers for each of the services. Seven transmitters will operate on two frequencies. There will also be a transmitter on a separate frequency for transmitting supervisory and coordinating messages, and a transmitter and receiver on the amateur frequencies.

Current plans call for the communications headquarters to be located in a large trailer (motor-truck-line type). Several remote locations will be established for tying into telephone and power lines. As safety measures against possible sabotage, the center will be moved from time to time, and it will be unidentified insofar as call-letters are concerned. In addition to power connections at selected points, the trailer will be equipped with a gasoline-driven 110-volt a-c 10,000-watt generator.

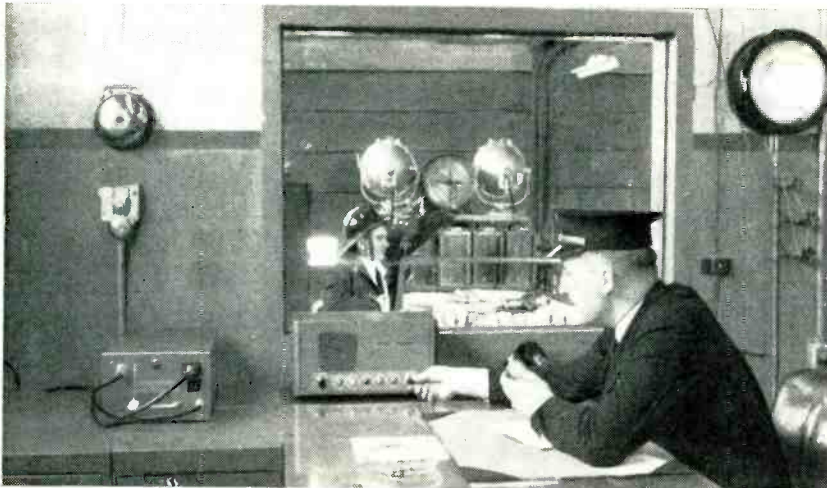

FIRE DEPARTMENT radio equipment is incorporated into the overall network



UTILITIES are tied in



TAXICAB COMPANIES operating mobile two-way radiophones cooperate with C-D

It will be possible to operate all of the center's transmitters, and monitor transmissions for all of the coordinated services, from any one of four operating desks. Interlocks will prevent operation interference between desks.

When traffic is light, one operator will be able to perform all functions of monitoring, transmitting, and coordination. As traffic increases, a portion of it will be taken over by one or more additional operators at the other control desks. This division of duties will be conducted according to a predetermined plan.

Each operating desk will be equipped with key switches and relays to permit operation of all facilities. Each transmitter will be



TELEPHONE COMPANY mobile radio installations are incorporated in the plan



HIGHWAY MAINTENANCE radio equipment maintained by the county constitute an important link



CONSTRUCTION COMPANY maintaining its own private mobile radio system is part of the Onondaga County emergency network

protected by an interlock so that only one operator can operate it at one time. This plan affords maximum flexibility of control with a minimum of equipment.

"Alert" Receivers

Transmissions from the center on the coordinating frequency will be received at the dispatching points of the 13 services by means of an inexpensive receiver employing selective dispatch. All such receivers will be activated from the center by means of a tone-signalling system. They will, there-

fore, remain silent except to receive alerts and instructions from the center.

A tone-operated switch can be incorporated in these receivers, and used to activate warning and all-clear sirens directly from the trailer center. This will be extremely advantageous in some instances because the center will instantly receive alerts broadcast by the state-wide attack warning radio system.

All of the county's existing communication services are being encouraged to provide standby power equipment at their main stations. In addition, those services employing two-frequency operation are being asked to provide at least one of their mobile units with proper equipment to permit it to serve as an auxiliary dispatch station. Services operating on a single frequency need not alter a mobile unit to accomplish this but should have one mobile unit designated as an auxiliary dispatch station.

Four-Way Emergency Plan

Under the plan, there will be four possible dispatching conditions for each service. The first will be normal operation on regular power, then normal operation on standby power, then an auxiliary station in a mobile unit, and

finally the trailer communications center will take over in case of failure of the first three.

In event of an alert, the operators will go to the trailer, whose location will be known to them at all times.

The operators will monitor the various services, including the New York State attack warning system, and coordinate alerting that remains to be done. All alerting and general instructions will be transmitted on the coordinating frequency, and received by the selective-dispatch receivers. Transmissions will be kept at a minimum, as will transmissions on all frequencies. The primary consideration will be to allow the various services to continue their own dispatching so long as they are able to do so in accordance with the established plan set forth by Civil Defense Authorities.

Following the dropping of bombs, or other disaster, the trailer center will be moved to a location near the scene, or to an advantageous site previously determined. It will be moved by one of the tractors offered by four trucking companies.

Much of the equipment for this system is currently being installed. The system is scheduled to be ready for operation by mid-August.

Remote Control of

Simple follow-up control circuit using two double-triodes permits moving industrial valves, levers and other motor loads to any desired position at full speed merely by changing the setting of a remotely located control knob

THERE are many applications for simple electronic controls that operate relays to make a motor turn at full speed in one direction or the other to move an object or a load into a desired position. A small motor (up to $\frac{1}{8}$ hp) may operate directly from the relay contacts. For large motors to $1\frac{1}{2}$ hp, these relays may control the contactors of a reversing switch.

The electronic positioning control circuit shown in Fig. 1 is a general-purpose follow-up control that may be used with any type of motor to move an object into any position selected by turning a small dial.

As an example, a motor-operated valve can be controlled from a distance by turning potentiometer slider *A* to any point on its dial; immediately, perhaps 500 feet distant, the motor will turn at full speed until it has brought potentiometer slider *B* on the valve to the position that matches the setting of slider *A*.

Briefly, when no action is desired and the slider of *B* is in the same position as the slider of *A*, transformer *T* receives no voltage so tubes V_{1A} and V_{1B} are both passing current, and neither V_{2A} nor V_{2B} is passing enough current to pick up its relay. If the slider of *A* is moved up, this turns off V_{1A} so that V_{2A} passes current and picks up relay 1; the motor then turns FORWARD and its shaft drives the slider of *B* up also. Conversely, if the slider of *A* is moved down, this turns off V_{1B} so that V_{2B} picks up relay 2; the motor then runs in REVERSE so that the slider of *B* is moved down also.

This article is based on material contained in a book by the author, "Electronic Motor and Welder Controls", published this year by McGraw-Hill Book Co.

By **GEORGE M. CHUTE**

*Application Engineer
Apparatus Department
General Electric Co., Detroit, Mich.*

Although a-c voltages are applied to the plates of all tubes, no tube can pass current during the negative half-cycles of plate voltage. During the positive half-cycles, the left-hand terminal of dead-zone potentiometer *R* is 4 volts more negative than the cathode of V_{1A} . When transformer *T* is producing no voltage (so that no voltage appears across R_1 , R_2 , C_1 and C_2), the grid voltages of V_{1A} and V_{1B} may be varied between -4 and $+14$ volts, depending on the setting of *R*. Even when *R* is set so that the grids are negative, V_{1A} and V_{1B} pass a tiny current which, flowing through the high resistance of R_3 or R_4 , causes a large voltage drop across these resistors. The grids of V_{2A} and V_{2B} are held far more negative than their cathodes, so tubes V_{2A} and V_{2B} do not pick up relays 1 or 2. This condition continues so long as the slider of *A* is not turned away from the same position as the slider of *B*.

Potentiometers *A* and *B* are connected to the same 115-volt a-c supply, with polarity such that when their sliders are in the same position, the two sliders are at the same potential and no voltage is applied to transformer *T*.

Follow-up Action

Assume the slider of *R* is set at its extreme left, for minimum voltage. As shown in Fig. 1C, the potential of the slider now is close to the cutoff potential of V_1 . If the slider of *A* now is turned a small amount to the right, a small voltage difference (often called the error voltage) is applied to transformer

T during the positive half-cycles to make its secondary terminal positive.

Position-controller potentiometer *A* causes a phase shift between the signal voltage of *T* and the line voltage (or anode voltage of the tubes). Capacitor C_1 acts with R_1 to bring the voltage across C_1 in phase; this is the voltage used to control V_{1A} , as shown in Fig. 1B. This small signal voltage from *T* forces the grid of V_{1A} closer to cutoff, reducing the plate current through R_3 and thereby swinging the grid of V_{2A} in a positive direction so plate current of V_{2A} increases to pick up relay 1. The same signal voltage has the opposite effect on tubes V_{1B} and V_{2B} , hence relay 2 remains de-energized.

Tubes V_1 and V_2 actually serve as a two-stage amplifier. Moving the slider of *A* through half a degree causes only $1/5$ volt across the secondary of *T*. This tiny voltage at the grid changes the plate current of V_{1A} enough to vary the grid of V_{2A} by 6 or 8 volts; this makes the plate current of V_{2A} increase by 10 milliamperes, enough to pick up relay 1.

When relay 1 is picked up, a circuit is completed to the FORWARD contactor coil. The motor drives the valve load in the forward direction and also moves the slider of *B* to the right. This movement decreases the error voltage applied to *T* until the V_{1A} current increases and relay 1 drops out.

If the slider of *A* now is turned to the left, a voltage difference (or error voltage) again is applied to transformer *T*, but with opposite phase relation to the previous error voltage. Now, as shown in Fig. 1C, the grid of V_{1A} becomes more positive and relay 1 is not affected; the

Positioning Motors

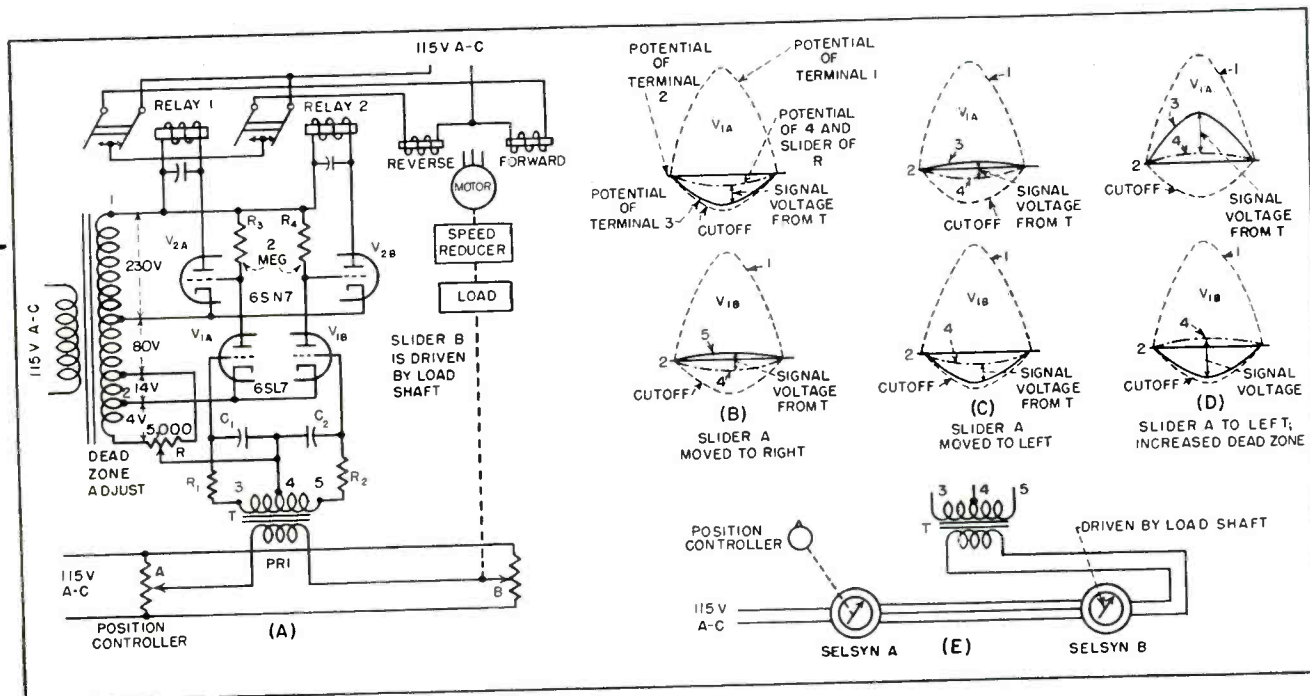

FIG. 1—General-purpose follow-up circuit for actuating contactors of reversible motor when knob of position controller is turned, waveforms of circuit voltages, and alternative controller arrangement using selsyns. Numbers on curves refer to potentials of correspondingly numbered transformer terminals in the circuit

grid of V_{1B} is forced more negative, decreasing the plate current of this tube and swinging the grid of V_{2B} more positive so that this tube picks up relay 2. This relay completes the circuit to the REVERSE contactor coil, so the motor drives the valve load in the reverse direction and moves the slider of B to the left until the error voltage at T decreases and relay 2 drops out.

Accuracy Versus Dead Zone

When dead-zone adjusting potentiometer R in Fig. 1A is set for minimum potential, a very small movement of the slider of A (perhaps only $\frac{1}{2}$ degree) may pick up relay 1 or 2; the motor turns, trying to position the load (such as a valve) and the slider of B to within this $\frac{1}{2}$ -deg accuracy. However, such close follow-up or accuracy can rarely be used unless the motor is stopped quickly (as by a brake on the motor shaft). When the motor brings the slider of B to the position where relay 1 drops out (thereby removing power from the motor), the motor and its load may coast far enough to move the slider of B beyond the slider of A so that

relay 2 picks up, reversing the motor. This may cause the motor to turn back and forth, although the slider of A is not being moved; this hunting action must be stopped.

If potentiometer R is now adjusted to raise the potential of its slider, as shown in Fig. 1D, the slider of A must be turned a greater amount (such as 2 deg) before the signal voltage of T is large enough to make V_{2A} pick up relay 1. Similarly, as the motor drives the slider of B toward the same position as the slider of A, relay 1 may drop out while the slider of B still is 2 deg out of line. This permits the coasting motor to drive the load and the slider of B through an extra 2 or 3 deg without causing V_{2B} to pick up relay 2. Advancing the slider of R thus produces a larger neutral or dead zone within which no correction occurs.

If the motor and load coast far enough to move the slider of B through 3 deg after relay 1 drops out, then R must be set to provide a dead zone of nearly 4 deg; this limits the accuracy to plus or minus 2 deg, since the slider of A may be

turned 2 deg before either relay operates. The accuracy of any follow-up system depends on the width of the neutral or dead zone needed to prevent hunting.

Selsyn Control of Positioning

In place of potentiometers A and B in Fig. 1, two selsyns may be used as shown in Fig. 1E. Three wires connect the stationary parts of the two selsyns. The rotor of selsyn A may be turned through 180 deg by the position controller dial; the rotor of selsyn B is driven by the load shaft. When the rotor of B is exactly in line with the rotor of A, no voltage is delivered by selsyn B to transformer T, so the motor does not move the load. If selsyn A is turned to the right, selsyn B produces an a-c voltage at T that may turn off tube V_{1A} and pick up relay 1; the motor then drives selsyn B to the right, decreasing this a-c voltage. When selsyn A is turned to the left, the voltage produced by selsyn B is of opposite phase and turns off V_{2A} , picking up relay 2; the motor then drives selsyn B to the left until relay 2 drops out.

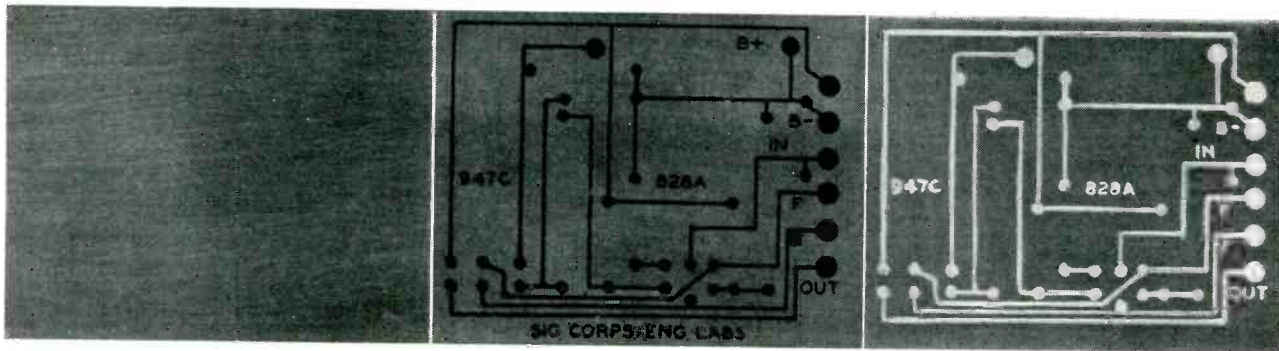

1 Copper-foil-coated phenolic chassis is starting point for auto-assembly of battery-powered audio amplifier

2 Conductor pattern is applied in acid-resistant ink by silk-screening or offset printing

3 Chassis after etching away unwanted metal in ferric chloride solution and removing resist

Auto-Assembly of Miniature

THE SYSTEM of miniature circuit assembly to be described was evolved as a result of several Signal Corps study programs, aimed at providing relief from the production, performance and maintenance problems attendant on highly compact sub-miniature equipment designs. The system designated as auto-assembly borrows the very convenient prefabricated conductor pattern of printed circuits, and permits rapid and effective electrical combination of this pattern with conventional quality components by a one-shot solder dip process. The elements of auto-assembly are: (1) Formation of the conductor pattern; (2) selection of components; (3) rapid assembly; (4) packaging.

By **S. F. DANKO**
and
S. J. LANZALOTTI
*Signal Corps Engineering Laboratories
Fort Monmouth, New Jersey*

Of the many techniques of metallization extant today, the etching of copper-faced laminates (electrolytic copper foil bonded to an insulating base) provides one of the most convenient means of pattern fabrication. In this subtractive process, a resist image of the desired conductor pattern is printed or otherwise delineated on the copper foil surface and the laminate then exposed to an etchant. The resist material protects the metal against the action of the etchant

during the short etching period. The Signal Corps Laboratories demonstrated early in 1949, in collaboration with the Etched Products Corp. of Long Island, that the commercial offset presses of the etched nameplate industry could be readily adapted to the deposition of such resists on commercially available foil laminates for subsequent etching.

The photo-etch technique of the graphic arts industry was equally well adapted to such resist fabrications, particularly where higher orders of definitions or reproducibility were desired. Several other metallizing techniques, including the Mallory pressed powder technique and the Franklin Air-Loop stamping process, are also compat-

Mobilization Advantages

- SAVES LABOR** by eliminating manual wiring, which ordinarily requires more man-hours than any other step in electronic equipment manufacture
- MINIMIZES REJECTS** because etched wiring is absolutely uniform from chassis to chassis
- ELIMINATES UNSOLDERED JOINTS** because all joints are made simultaneously in one solder-dip operation
- REDUCES INSPECTION TIME** because mechanization reduces probability of errors practically to zero
- SPEEDS ASSEMBLY TIME** because leads of components are simply pushed into holes, with no hook or wrap-around joints
- PERMITS GREATER MINIATURIZATION**, because etched wiring takes practically no space and lends itself to stacking of chassis layers
- IMPROVES RELIABILITY**, because auto-assembly practically eliminates short-circuits between connections and leads

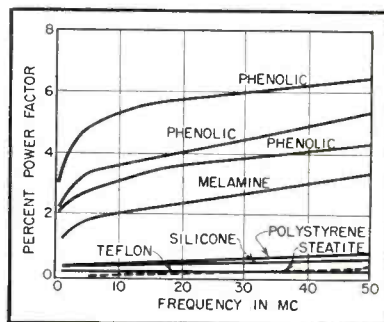
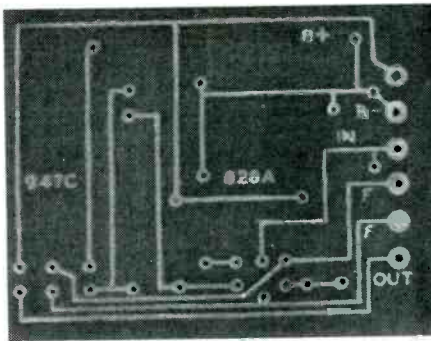
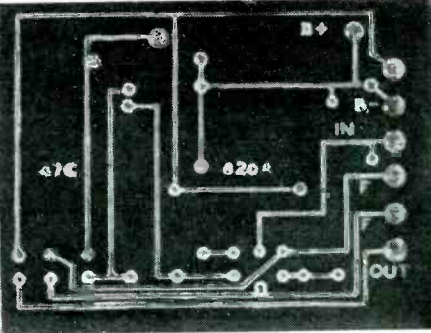

FIG. 1—Variation of power factor with frequency for some of the double-faced laminates used in auto-assembly. Note variations in phenolics from three different suppliers. Melamine, polystyrene, silicone and Teflon materials are glass-fabric or glass-mat loaded



4 Next step is punching or drilling of holes through which leads of components are inserted from rear



5 Underside of chassis after components are mounted and assembled by one-shot solder dip

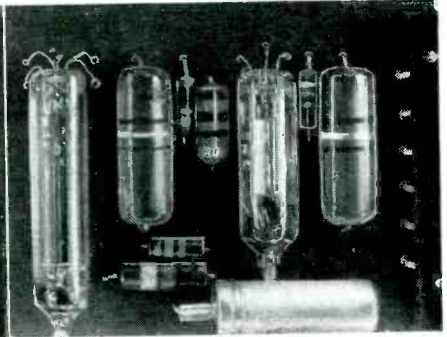

6 Top of completed chassis, showing layout of tubes and components, with plug-in terminals at right

Military Equipment

Production of wiring by acid etching of copper-faced insulating laminates permits rapid assembly of high-quality conventional JAN components by inserting leads in punched holes, then immersing chassis surface in molten solder to make all joints simultaneously

ible with the auto-sembly system since they yield high-conductivity patterns which are amenable to component assembly by solder dipping.

It is the intention of this presentation to emphasize the etched-foil technique of preparing a conductor pattern, inasmuch as this process lends itself excellently to pattern fabrication by the laboratory designer for prototype model constructions. The choice of a process for forming the pattern for production depends on such factors as the detail required in the pattern, quantities involved, tooling costs, production rate and delivery time.

Laminates

The physical characteristics of the commercially available copper-faced laminates which are of prime interest for auto-sembly include bond strength of the foil to the laminate, compatibility of this bond with the temperature shock conditions which it will experience during solder dipping, dielectric constant, power factor, arc resistance and moisture absorption. Table I lists in a general way some of this physical data for comparison purposes, and Fig. 1 shows

the relation of losses to frequency for several of these laminates. It should be noted that these loss curves apply where the base material is used as the total dielectric, between metallized faces on opposite sides of the material. In the usual application, where capacitances between adjacent lines are of concern, the losses are substantially lower than indicated since the dielectric is part air.

The laminates are also available

with copper on both sides to permit fabrication of aligned patterns on both faces. Most common thicknesses of copper are 0.00135", 0.003" and 0.005".

Resists

Within the design laboratory, screening of the resist is perhaps the simplest and most convenient method of printing the pattern prior to etching. The screens themselves may be prepared by any of

Table I—Characteristics of Copper-Faced Laminates

Laminate Chassis	Reported Bond Strengths* (lb)	App. Dielectric Constant	Power Factor at 1 mc	Moisture Absorption (24 hr)	Arc Resistance	Max. Operating Temp.
XXXP Phenolic	6-8	3.5-5.5	2.8 %	1.3 %	Poor	125°C
Melamine—						
Glass Fabric	7-9	6.8	1.3 %	2.0 %	V G	135°C
Silicone—						
Glass Fabric	2-8	—	0.35%	0.3 %	V G	200°C
Teflon—						
Glass Fabric	3-7	3.3	0.10%	0.3 %	V G	200°C
Polystyrene—						85°C
Glass Mat	2-3	—	0.38%	0.55%	—	
Polyester—						
Glass Fabric					Fair	135°C

*Bond strengths are measured by pulling a scored one-inch copper strip vertically away from the laminate surface. The bond strengths vary among manufacturers but the values shown indicate the general range of values measured. (The bond strength of copper-phenolic is an exception, being representative of one manufacturer's item.)

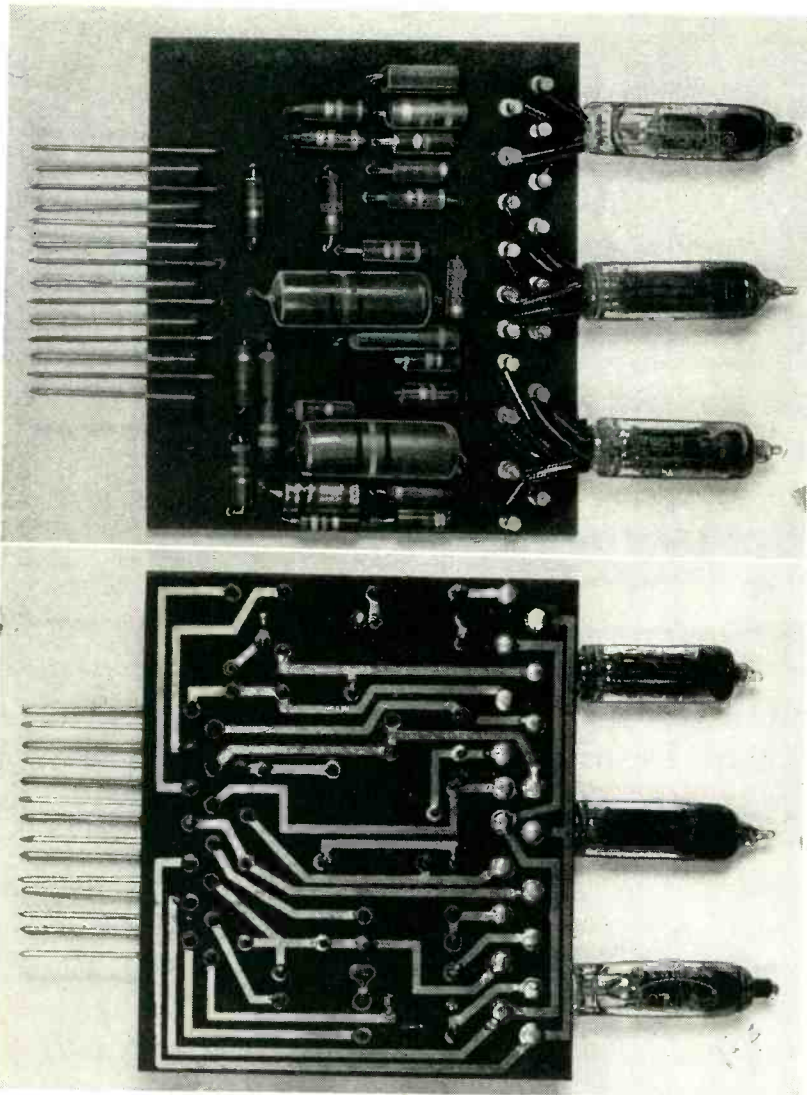

Top and bottom views of auto-assembled chassis containing phase-shift oscillator, avc, and clipper-limiter circuits that serve as a unitized packaged plug-in assembly for a complex electronic fault locator. Embedment of chassis in casting resin will provide protection against moisture and give rigidity to plug-in terminals at left

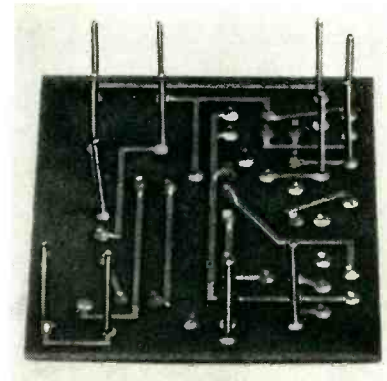

Detailed view of solder-dipped pattern. Fillets at termination points are obtained by using a waxy flux. Long protruding leads go between components and into holes in next layer

sary holes through the pattern at each termination point. In the laboratory, of course, these perforations would be drilled or punched.

Conductor Characteristics

The thinner copper foils have more than adequate conductivity for general miniature circuit applications, as indicated in Table II. A 1.35-mil-thick conductor $\frac{1}{32}$ -inch wide on a representative 3 x 2-inch phenolic plate will carry over 3.5 amperes continuously with a 40-degree C maximum temperature rise of the conductor. A similar 3-mil-thick conductor under the same conditions will carry over 5 amperes. A studied effort has been made to discourage use of such ratings as fusing currents, peak current capacity and similar short-time ratings which do not provide useful information for a designer's guidance.

For general conductor applications a line width of about $\frac{1}{32}$ -inch is recommended, although widths down to 1/64-inch are dipped consistently. Experience to date indicates that an area of metal equivalent to about a $\frac{1}{16}$ -inch-diameter circle at each junction point is desirable since a well-formed and substantial fillet of solder will then be built up. Spacing of lines, in general, should be kept at least at $\frac{1}{32}$ -inch unless otherwise demanded by pattern layout.

On phenolic surfaces, the peak flash-over voltages at room ambient conditions with no coating protection over the $\frac{1}{32}$ -inch pattern spacings were about 1,800 v. This

the many commercial screening organizations or may be prepared within the laboratory without too much art or effort. For most general line work for conductors, a screen mesh of about 150 per inch is adequate.

Satisfactory resists for screening are many, but synthetic screening enamels available from the art supply houses have been particularly useful in this application. An example is the Synthetic Screen Enamel, series 1500, any color, obtainable from the Colonial Process Supply Co., New York City. Resists made by dissolving asphaltum in an appropriate vehicle are also convenient, but care must be taken to get the proper screening consistency. The synthetic enamel resists require approximately 8 hours to

dry (overnight, or may be oven dried in a few hours).

The foil laminates with the resist patterns may be etched in a rocking tray or may be mounted copper face down about one-half inch over the surface of the etchant, which can then be agitated by bubbling air violently through the solution. The recommended etchant for copper is a 50-percent solution of ferric chloride. This will etch through a 1.35-mil foil in about 5 to 7 minutes depending on the freshness and temperature of the bath. The patterns are then washed in running water, following which the enamel resist can be removed by use of a thinner or by light abrasion. Commercially these patterns would then be processed through a die stamping operation to provide the neces-

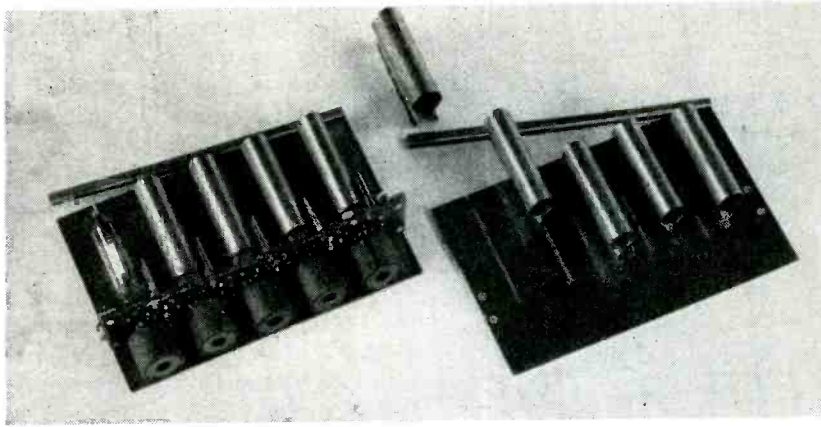

Experimental five-stage impedance-coupled i-f amplifier having heat-dissipating metal back plate and individual metal tube envelopes for conducting tube heat to the plate

$\frac{3}{32}$ -inch spacing has been used consistently on 300-v d-c circuits, with no failures recorded. In this respect, the desirable arc resistance features of some of the laminates are strong points in their favor. With this spacing, insulation resistances well over 100,000 megohms under ambient room conditions are measured between 3-inch-long copper lines on phenolic with no protective finishes applied.

The distributed capacitance between lines is significant and cannot be ignored at the higher frequencies. On XXXP phenolic, this capacitance is of the order of $1 \mu\mu\text{f}$ per inch for $\frac{3}{32}$ -inch spacing and $0.7 \mu\mu\text{f}$ per inch for $\frac{1}{8}$ -inch spacing. These values will be lower for the lower dielectric constant materials. Proper pattern layout will allow use of very short sections of r-f conductors, and it has been convenient at times to run short ground lines between two critical conductors to reduce this electrostatic coupling to a still lower figure.

Although the inherent power factor of such materials as phenolic is fairly high, the effective power factor is considerably better inasmuch as the dielectric of the distributed capacitance is part air and part insulating material. As a generality, this pattern capacitance can be said to be comparable in magnitude to that which may be encountered in conventionally wired compact assemblies, but with the advantageous feature of being identical from pattern to pattern.

The commercial offset press process can yield line work of the order

of 8 to 10 mils in width as a matter of routine production. The photo-etch technique yields conductor widths down to about 4 mils without premium charges. These higher definitions are useful in delineating the precise geometry required of spiral-formed coils such as have been used in television tuners and high-frequency i-f coil patterns.

It is recommended that the finished copper patterns be silver-surfaced by dip plating (which yields a satisfactory flash coat) or by direct plating to eliminate oxidation of the metal on long storage with the subsequently increased difficulties of cleaning. The commercial etching houses will supply such surfacing as a matter of normal production processing.

Table II—Resistances of Etched Copper-Foil Conductors

Line Width (inches)	Ohms per Inch at 20°C for 100% Conductivity Copper		
	0.00135" Thick	0.003" Thick	0.005" Thick
1/100	0.050	0.023	0.014
1/64	0.032	0.015	0.0087
1/32	0.016	0.007	0.0043
3/64	0.011	0.005	0.0029
1/16	0.008	0.0035	0.0022
3/32	0.0054	0.0024	0.0015
1/10	0.0050	0.0022	0.0014
1/8	0.0040	0.0018	0.0011
5/32	0.0032	0.0015	0.0009
3/16	0.0027	0.0012	0.0007
1/4	0.0020	0.0009	0.00055
3/8	0.0013	0.0006	0.00037

Copper has been mentioned exclusively as the conductor material because of commercial availability of the copper-surfaced laminate. However, some of the etching sources which do their own laminating have prepared patterns of brass, silver, iron, aluminum, bronze and even spring-tempered steel for special purposes. Some of these metals have proven particularly useful in delineating patterns for switches. It should be mentioned, too, that these laminators-etchers can supply embossed, flush or subsurfaced patterns for special purposes or provide upset metal nodules on the patterns where required for switch contact points.

Components

Auto-sembly requires that the components have stiff protruding terminations, preferably of a radial type, such that the component can be conveniently inserted into its designated place on the insulated side of the chassis. Resistors, capacitors or other components having axial leads can have these leads cut and shaped by jiggling machines built for this purpose. The production arrangement can be such as to have the operator hold the conventional component momentarily in the jig for shaping and then in the next motion insert it into place on the pattern. The alternate proposition would be to supply the operator with pre-jigged components. Components where stiff protruding terminations are desired include termination devices such as sockets, connectors and receptacles. Current Signal Corps developments aim to provide such electro-mechanical devices that are particularly adapted to auto-sembly or other card-type systems.

Most conventional components can be readily adapted to auto-sembly mountings. The use of conventional components is considered a desirable and realistic approach in this miniaturization technique. The designer has available for his choice not only the variety of components but also the full range of tolerances, electrical characteristics and physical sizes in the established quality lines of JAN or commercial components. There are no special skills imposed on the assem-

bler of the equipment such as would be required if he were to deposit or print his own resistors or capacitors. The fabrication of such deposited components is still a highly specialized art. Where economic or performance advantages can be realized in any fabrication through the use of these printed circuit aggregates, then such groupings of deposited components (such as Couplates, Bulplates and multi-value capacitors) can be treated like any other component for auto-assembly.

Assembly

The use of the one-shot solder-dip technique has been particularly convenient in the fabrication of highly miniaturized assemblies. In this operation the insulating base, with the fluxed pattern on the underside and the components mounted on the topside, is momentarily dipped in a eutectic solder bath (63 percent tin, 37 percent lead) maintained at about 450 F. The period of dip recommended is of the order of two or three seconds, but this time may be increased if large areas of copper are left on the pattern for shield purposes or as heat radiation surfaces. Periods of dip as high as ten seconds have been made without delamination or deleterious effects on such base materials as phenolic, Teflon or silicone.

The success of the solder dip procedure is particularly dependent on the flux used just prior to solder dipping. The following formulation has been found successful: 1 part Glyco Wax No. S932 made by the Glyco Corp., Brooklyn, N. Y.; 1 part Kester No. 1015 (activated rosin in alcohol flux) made by the Kester Solder Co., Newark, N. J.; 1 part toluene (more toluene may be added if a thinner consistency is desired). The bath should be kept warm during use (about 110 F). The flux itself may be applied by dipping the pattern side momentarily in the flux or by brushing the flux over the pattern.

It is important that the pattern be removed from the surface of the solder bath with a sidewise lifting motion. This technique yields a soldered pattern with well-formed fillets at each termination point and a more or less hemispherical cross-

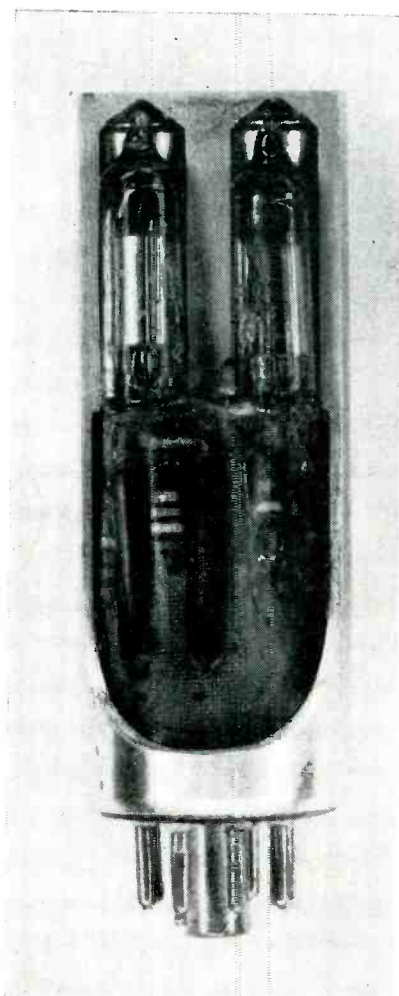

One-watt audio amplifier with portion of metal heat-dissipating container cut away to show use of folded circuit. Components are auto-assembled on flexible Teflon chassis that is rolled up and inserted in container, then cast in resin. Subminiature tubes fit into machined holes in solid metal end of container

section of solder on the conductor lines. The pick-up of solder on the conductor lines is extraneous and incidental to the process but it does add to the total conductivity of the conductors. One manufacturer on a production line basis has evolved a variation of this technique wherein his solder dip procedure deposits mechanized solder only at the termination points, a desirable process from the point of view of solder economy.

Packaging

Packaging includes ruggedization, moisture protection, adequate heat transfer and provision of connective components such as may be required for plug-in use. Use of right-angled connectors provides a

convenient means of integrating a connector quickly to the pattern since such a connector is treated as any other component in the course of the assembly operation.

Although stiff laminates have been discussed up to now, flexible laminates have been used as the chassis for the pattern in making folding circuits. Assemblies on thin sheet Teflon glass laminates and on silicone rubber (thicknesses of 3 to 10 mils) have been auto-assembled and then folded and inserted into capsules.

Conclusions

The complete and detailed coverage of all aspects of the auto-assembly system have not been presented here because of the voluminous nature of an exhaustive treatment of the subject. It can be shown, for example, that sections of auto-assembly circuitry can be decked by providing completed solder-dipped auto-assembled sections with stiff swaged-on protruding connectors which can be inserted into place on another deck and then solder-dipped into place. Cross-overs can be made by eyeletting and subsequent spot-soldering on double-faced laminates, or by use of staple-shaped wires as components.

The information as presented has been intended to show some of the more basic concepts and techniques of auto-assembly and the major considerations which govern its current applications in service and commercial equipment application. The use of the etched pattern and the auto-assembly system of integration both provide effective tools which are not necessarily limited to electronic circuit fabrication. These patterns, for example, are used in the preparation of heaters, Faraday shields, switching devices, and in one instance even for forming low value bypass capacitors. Auto-assembly is being used in new military equipment designs and is currently applied commercially to repetitive types of circuits such as are used in counters. The extrapolation of auto-assembly to other applications is dependent almost entirely on the imagination of designers familiar with the capabilities of these tools.

Automatic TV Sync Lock

Facilities for special effects can be applied to an incoming video signal from a remote point, such as a network broadcast. The local sync generator is synchronized to the remote with horizontal afc control and phase-correction control of the vertical interval

By L. M. LEEDS

*Electronics Department
General Electric Company
Syracuse, New York*

TELEVISION programming requirements continually demand increased versatility on the part of the technical facilities.

Equipment is available to perform various special effects such as montage, superposition, lap, fade and wipe dissolve, as long as all program material is obtained from studio and film channels referenced to the same synchronizing generator. The application of these local technical facilities to program material originating at a remote point necessitates that the local synchronizing generator be synchronized, both in frequency and phase, with the mixed sync of the composite remote signal. A sync lock unit performs this synchronizing function.

With a sync lock system a picture signal coming in from a remote point of origination, such as the signal from a network, an off-the-air receiver, a satellite studio, or a remote pickup, can be treated and handled just as though it originated in an adjoining local studio. All of the special effects facilities can be applied to this remote signal.

For example, local commercials can be surreptitiously inserted into a network show of a nationally advertised product. On a local remote pickup it is not necessary to transport extensive additional equipment to the pickup point or, alternatively, to switch composite video signal to the local sync generator, with a flapping disturbance, for each commercial or local program insertion.

A remote signal, either from the network or off the air, frequently exhibits bad spiking of the front porch, sync distortion, obliteration of the sync by noise or improper front-porch width. With an adequate sync lock system such a distorted composite remote signal can be reconstructed with clean sync.

The sync lock must provide solid and undisturbed synchronization of the local sync generator. Additionally, it must provide front-porch width adjustment, remotely controlled from the station video control position, so that the time phase between remote signal blanking and reintroduced local sync can be matched quickly to the local system setup. For maximum utility the sync lock should be automatic in

operation and free from critical adjustment such as clipping level controls. A sync lock unit which meets these requirements has been developed.

Locking Method

Synchronization of the associated local sync generator to the remote sync generator is accomplished by automatic frequency control of the master oscillator of the local sync generator and automatic phase-correction control of the vertical interval. Since the remote signal is composite video and sync, as obtained from a network connection or from an off-the-air receiver, it is necessary to separate out the video and retain the

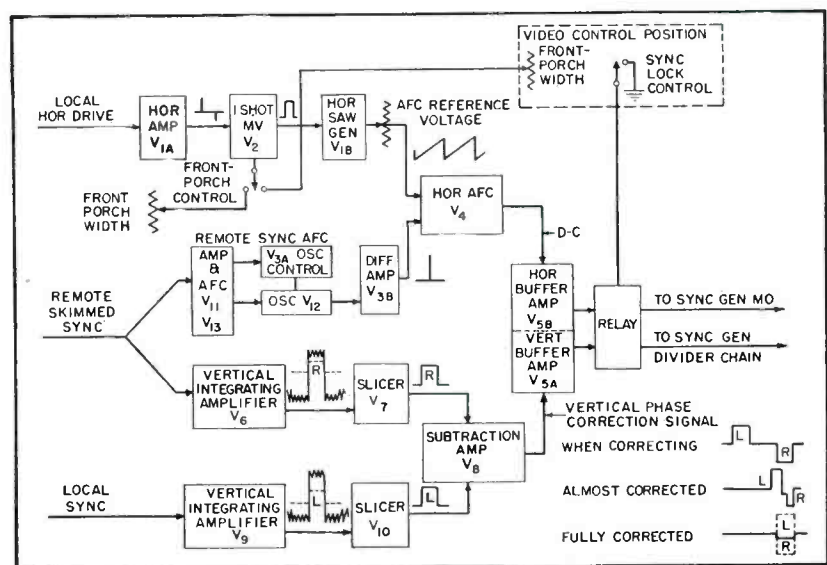

FIG. 1—Stages of the sync lock and their functions

skimmed sync for use as the input remote mixed sync signal. Skimming of the sync is normally accomplished through the use of a stabilizing amplifier.

The basic functions of the various portions of the sync lock are shown in Fig. 1. There are only two operational controls, both of which are most conveniently located at the video control position of the station. These controls are the sync lock REMOTE-LOCAL with push-button switch and the FRONT-PORCH WIDTH adjustment for the sync lock.

Horizontal AFC

The horizontal afc, V_4 , performs the function of automatic frequency control of the master oscillator of the local sync generator. It utilizes a sawtooth waveform, derived from the local horizontal drive, and a narrow pip derived from the horizontal sync of the incoming remote sync signal.

The narrow pip allows the instantaneous value of the sawtooth voltage occurring at the time of the pip to charge the output capacitor of the afc. This voltage controls the frequency of the master oscillator of the sync generator. If this oscillator, and hence the repetition

rate of the sawtooth, is not at the correct frequency the subsequent pips will alter the d-c output voltage of the afc, thus changing the oscillator frequency.

The phase relations of the afc, the d-c control voltage and the oscillator frequency are such as to adjust the frequency so that the pip will always occur at the same voltage level point on the fast part of the sawtooth. Any attempt on the part of the oscillator to change frequency is immediately counteracted by a change in the d-c controlling voltage in a direction to correct the frequency change.

The narrow pips at horizontal rate, to feed the horizontal afc, are derived from the incoming remote skimmed sync. They are maintained synchronous, even though the input sync may be badly distorted by noise, by the utilization of a closed-loop sync afc system. These circuits are analogous to the horizontal sync circuits used in a modern receiver. In this adaptation the sync afc is a pair of diodes, a part of V_{11} and associated circuits.

Filter circuits are employed to stabilize the afc and to prevent frequency modulation of the generated narrow pip, output of V_{3B} , caused by the disturbing action of

the equalizing pulses and serrated pulses occurring during the vertical interval. The d-c output of the sync afc controls the effective resistance of the oscillator control tube, V_{3a} . Change in this effective resistance controls the frequency of the sync oscillator, V_{1c} .

Although this is a sine-wave oscillator, the circuit arrangement is such as to generate a sawtooth waveshape at the plate and this is fed back to the sync afc. Also, the sawtooth is differentiated in the grid of V_{3B} and amplified, thus forming the narrow pip signal required to feed the horizontal afc.

The sawtooth waveshape for the afc is generated in V_{1B} and is synchronous with the local sync generator horizontal drive. The d-c axis for this a-c voltage is set by the afc reference voltage, the value of which is determined by the particular sync generator with which the sync lock is associated.

The time duration of the fast part of the sawtooth is determined by the width of the pulse generated in the one-shot multivibrator, V_2 , and is adjustable over a suitable range by the front-porch width control.

Front-Porch Width

The multivibrator pulse, the length of which determines the front-porch width, is initiated by the leading edge of the local horizontal drive input signal. Since the width of the multivibrator pulse is controlled by a d-c voltage, a very simple remote control of the front-porch width is obtained.

The way in which an incorrect front-porch width on the incoming remote sync is corrected through the front-porch width adjustment, where the system is operated with reintroduced local sync on remote blanking, is shown in the phase relations diagrams of Fig. 2.

Figure 2 shows the conditions when the remote sync has a narrow front-porch width. For illustration, remote blanking, sync, and front-porch are assumed as 11, 4.8, and 0.5 microseconds respectively. The narrow pip signal, output of V_{3B} , is shown as being one microsecond delayed from the leading edge of remote sync. This delay of about one microsecond was designed into the

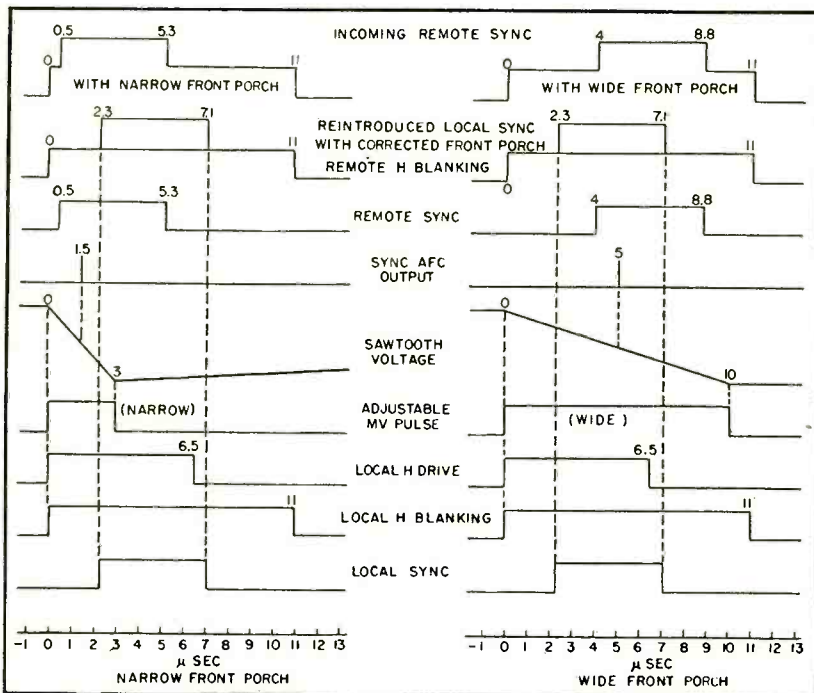

FIG. 2—Time-phase relations when correcting narrow and wide front porch on incoming remote sync

sync a/c to obtain the most effective range of front-porch width adjustment.

If the a/c reference voltage has been centered with respect to the local sync generator master oscillator control voltage, the sawtooth voltage, output of V_{1B} , will straddle the narrow pip signal equally in time as shown. This fast part of the sawtooth was caused by the multivibrator pulse which, in this example, was set to be 3 microseconds in length. Since the leading edge of local horizontal drive initiated the multivibrator pulse, and since local sync, as determined in the sync generator, is assumed as 2.3 microseconds later, reintroduced local sync will time-phase with remote horizontal blanking as a front-porch width of 2.3 microseconds.

When the incoming remote sync has a wide front porch, correction is obtained by setting the front-porch width adjustment so that the multivibrator generates a long pulse, as also shown in Fig. 2. In this illustration the front-porch width on the incoming remote sync is assumed as 4 microseconds. By setting the length of the pulse to 10 microseconds the time phase of local horizontal drive and local sync will be shifted so that reintroduced local sync will again be corrected to 2.3 microseconds. Thus the width of the multivibrator pulse serves to alter the time phase of the local sync generator relative to the remote sync and blanking, hence providing front-porch width control.

Vertical Phase Correction

Automatic phase correction of the vertical interval is obtained by the comparison in time phase of pulses corresponding to the serrated intervals of the local and remote sync. When these pulses are not in time coincidence, that corresponding to the local is used to suspend or hold the count down between the twice-horizontal rate pulses and the counted-down field rate pulse of the local sync generator by, presumably, four half-lines each field. This suspension of count continues in subsequent fields.

As the correction approaches finality, the pulses from the remote

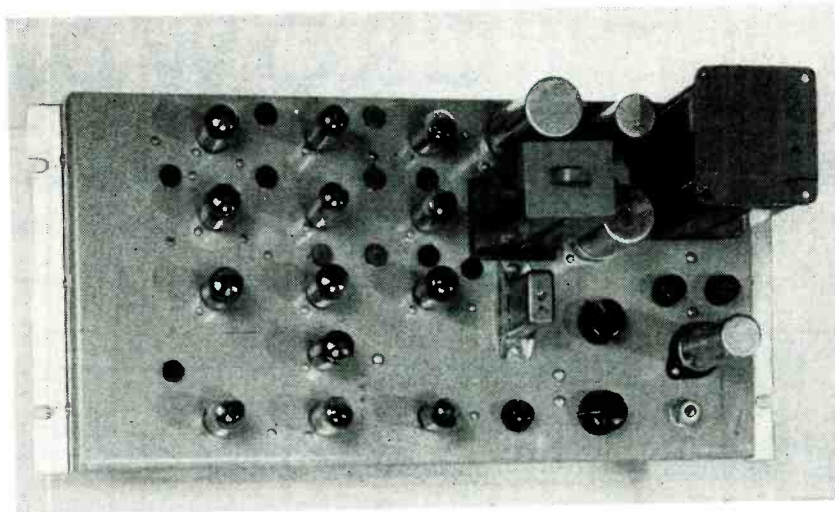

Rack-mounting chassis connects to associated equipment by coaxial cables feeding from backside

and local start to overlap. A portion of the positive-going local pulse disappears in the negative-going remote pulse, thus reducing the number of suspended counts. When the phase is fully corrected to coincide with the correct field, the correcting signal has been cancelled. Since at the time of initiating sync lock the vertical phases of the local and remote are perfectly random, it works out that the most probable value for the time of vertical pull-in is 1.1 seconds. Horizontal pull-in is practically instantaneous, a matter of only a few horizontal lines.

In obtaining the vertical rate pulses corresponding to the serrated intervals, the mixed sync in both local and remote channels is integrated and then sliced. The slicing operation is equivalent to a simultaneous top and bottom clipping and is accomplished with circuits which require no clipping level controls, nor are any provided. Slicing is precise and independent of the channel input voltage between the design levels of 3.5 to 8 volts.

Slicing on the local channel is done at a higher level on the integrated pulse than on the remote channel, thus assuring that the local pulse will always be slightly narrower than the remote pulse so that, in the subtraction amplifier, the positive-going local pulse will always completely disappear in the negative-going remote pulse when phase coincidence is obtained.

The General Electric Sync Lock Type TV-30-A was designed to

operate in conjunction with synchronizing generators of both GE and RCA manufacture. Operation with other sync generators has not been fully investigated.

System Considerations

In system operation with a sync lock, especially when a station has only one sync generator, consideration should be given to the time required for the local sync generator to get back to local power line lock when it is desired to leave the remote signal. This situation should be anticipated at the termination of a remote program since network sync may be opened as a result of repatching of the system. The time requirement is dependent upon the design of the sync generator and has nothing to do with the sync lock. Sync generator GE type PG-2-B, which employs a comparatively rapid a/c, is especially adaptable to a sync lock system since pull-in time to local power line lock can normally be accomplished during the switching time from remote to local picture.

Consideration also should be given to the local film projector to obtain maximum flexibility and utilization of a sync lock system. When the special effects are to be applied between a remote program and local movie film, it is necessary that the projector be completely synchronized to the local sync generator rather than to the power line. Such projectors are now available thereby making possible a completely synchronized system.

CROWDED-BAND

Transmitter-receiver combination operates in 148 to 174-mc range. Receiver uses triple-tuned i-f transformers to minimize adjacent-channel interference and controlled r-f gain to minimize intermodulation interference. Field test results are given

THE ever-increasing use of the channels in the 148 to 174-mc range has brought with it many equipment design problems. The solution of these problems has led to the development of many improvements in receivers and transmitters. The design of equipment capable of performing satisfactorily under present-day crowded-band conditions is further complicated by the requirements of simplicity, reliability and ease of serviceability.

Types of Interference

There are two general types of interference that are especially troublesome to mobile equipment operating in this range. These are adjacent-channel interference and intermodulation interference. These two types are quite different, both in their nature and in the measures that must be taken to minimize them.

Adjacent-channel interference caused by the presence of a strong signal on the next channel 60 kc off, takes three forms, desensitization or reduction of gain due to self-bias being developed on the grids of the i-f amplifiers or mixers;

break-through of adjacent channel signal reaching the discriminator although greatly attenuated; and noise interference produced by on-frequency noise sidebands radiated by the adjacent channel transmitter.

Desensitization is minimized by keeping the gain ahead of the selectivity determining stages (usually low i-f stages) as low as possible consistent with good sensitivity. With good design desensitization effects can be kept small compared with noise interference.

Modulation break-through can be reduced until it is less than the noise interference by adequate i-f selectivity. Noise interference, which is a characteristic of the transmitter and, therefore, unaffected by receiver design, will then be the limiting factor in adjacent-channel interference. A study of the various ways of achieving the required selectivity showed that triple-tuned low i-f stages in a double superheterodyne circuit resulted in the most efficient use of tuned circuits, the fewest number of tubes, and the simplest circuitry.

Intermodulation interference re-

sults from the generation of a carrier by two signals spaced n channels and $2n$ channels from the signal frequency, where n is any integer. This kind of interference results from components generated in the r-f tubes and appears as an on-frequency high i-f signal. Any circuitry after the first mixer will have equal effect on the desired signal as well as the interference.

The steps that can be taken to change the intermodulation characteristics of a receiver are limited, particularly with regard to that produced by the adjacent and the alternate channel signals. With choke channel spacings these signals pass through any practical 150-mc circuits virtually unattenuated. It takes a resonant circuit with a Q of the order of 2,000 to 3,000 to produce any appreciable attenuation. This can be accomplished with a well-designed cavity resonator but it is impractical as the cavity is larger than the whole mobile unit and costly to build. Some improvement in intermodulation attenuation can be realized by using only enough r-f gain to obtain the required sensitivity, because changes in r-f gain will have greater effect on the intermodulation product than on the desired signal. It is more effective to reduce the gain of the first r-f stage than that of the second. For areas in which the desired signal is greater than the level required to produce 20-db quieting, it is advantageous to use automatic gain control to reduce the r-f gain.

In any receiver it is important to have enough selectivity to insure that the adjacent-channel performance is at least equal to the intermodulation performance. Freedom from intermodulation interference

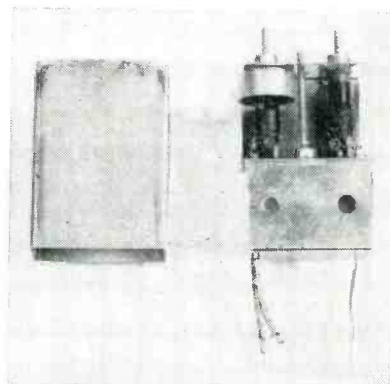
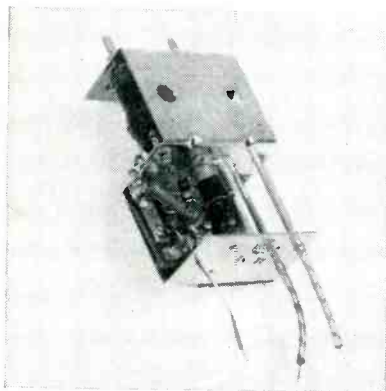

Upper compartment of i-f transformer assembly houses primary and tertiary windings. Secondary winding is housed in lower compartment

MOBILE EQUIPMENT

By **H. H. DAVIDS**
and **T. J. FOSTER**

General Electric Company
Electronics Park
Syracuse, New York

at a given point is valueless if adjacent-channel breakthrough occurs. In a practical design, it is often advantageous for the adjacent-channel performance to exceed the intermodulation performance, for interference from the latter requires simultaneous operation of both interfering stations, and therefore in many applications will occur only a fraction of the time the adjacent-channel station is on the air.

Receiver Design

The receiver whose block diagram is shown in Fig. 1 was designed in accordance with the considerations mentioned above. It has been thoroughly field tested to prove its ability to operate under conditions of severe adjacent-channel and intermodulation interference resulting from the presence of both adjacent and alternate channels.

The receiver has a guaranteed 20-db quieting sensitivity of better than 0.6 microvolt and an image and spurious response rejection of greater than 95 db. In production the sensitivity is actually running between 0.35 and 0.5 microvolt. This is achieved by using five slug-tuned coils of $1\frac{1}{2}$ turns of bus wire, $\frac{1}{4}$ inch in inside diameter, mounted in individual $\frac{3}{8}$ -inch diameter shield cans. Two ceramic tuning capacitors in parallel are mounted inside the can, so connected that by clipping an external link on the coil base the range can be changed from 148 to 162 mc to 162 to 174 mc. One of these coils has a capacitance tap to match down to a 50-ohm coaxial cable and constitutes the antenna transformer. The other four are coupled together in pairs with high side capacitance coupling to form two double-tuned r-f stages.

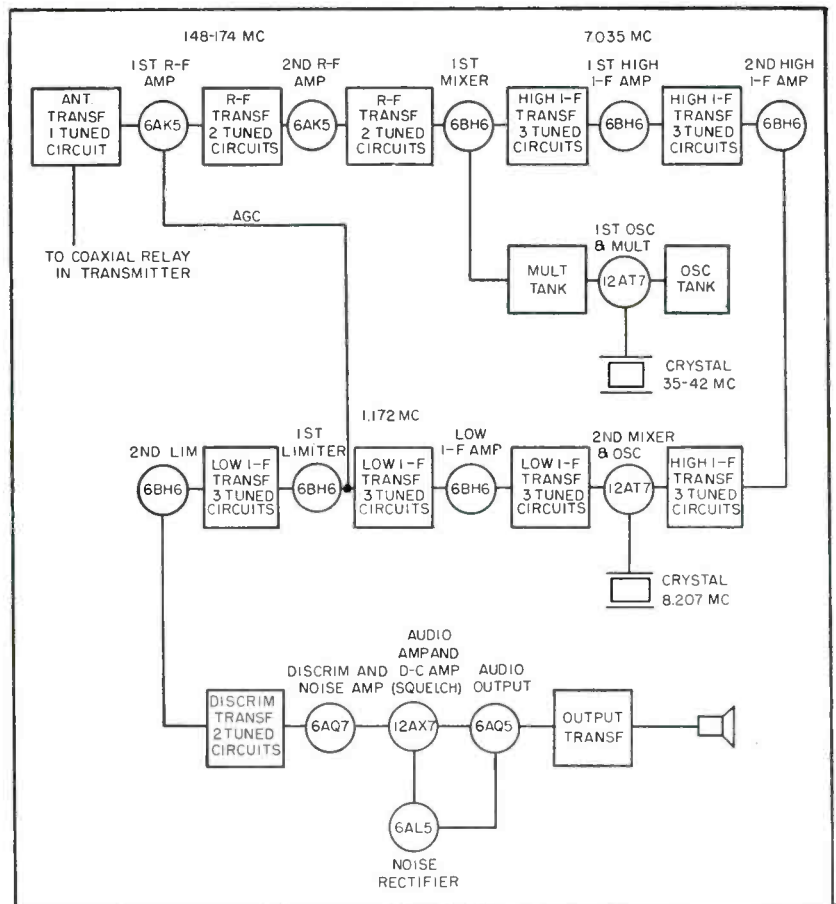

FIG. 1—Receiver block diagram shows double superheterodyne circuit

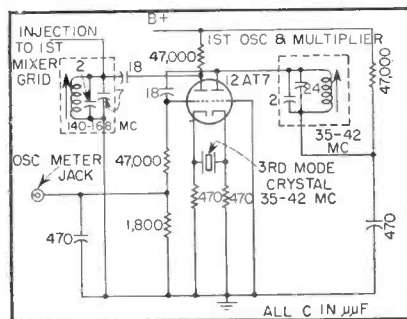

FIG. 2—First local oscillator employs third-mode crystal in 40-mc region

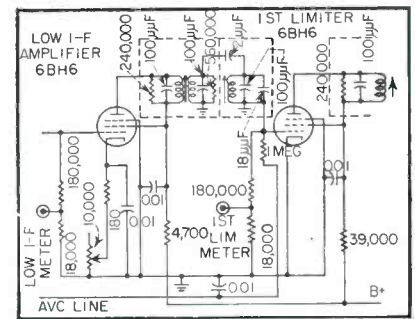

FIG. 3—Circuit of low i-f amplifier and first limiter shows use of triple-tuned i-f's

The performance of these tuned circuits compares very favorably with that of resonant concentric lines and this construction is much more simple and trouble free.

For the same considerations of sensitivity and r-f selectivity, 6AK5 tubes are used in the r-f stages, since the input resistance of any other suitable tube at 160 mc is much lower, resulting in increased

loading and loss of gain and selectivity.

Other than the individual coil shields, the only r-f shielding necessary is a vertical shield between the r-f stages and oscillator-mixer stage.

Another factor in the excellent spurious rejection of this receiver is the use of separate crystals for high and low i-f injection, permit-

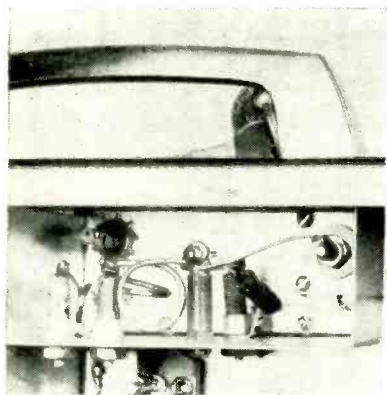

Under-chassis view of low-pass filter used in series with antenna coil

ting the use of a third mechanical mode crystal for the high injection. This type of crystal operates at a frequency of from 35 to 42 mc depending on the signal frequency, and requires only quadrupling before injection. This greatly reduces the number of undesired oscillator harmonics that would be produced if a lower frequency crystal were used and the number of multiplications increased. Moreover, these fewer harmonics are widely spaced from the desired injection frequency, 35 to 42 mc for the nearest, so that the r-f selectivity gives ample protection.

A cathode-coupled oscillator circuit is used for the first oscillator as this circuit gives very stable operation with a mode crystal, and also provides multiplication by tuning the second tank circuit to a harmonic. The oscillator circuit is shown in Fig. 2.

Triple-tuned i-f transformers are used in the two high i-f stages. While the selectivity of the high i-f contributes only a little to the overall selectivity, it does protect the receiver against spurious responses occurring at the second mixer.

I-F Design

Both high and low i-f transformers are of the same basic design. A folded metal frame provides a means of mounting the coils and complete shielding between the primary and secondary. The primary and tertiary in the upper compartment are inductively coupled, the coupling being controlled by a coaxial shield around the upper part of the primary wind-

ing. The tertiary is coupled to the secondary by means of a feed-through in the frame and a coupling capacitor. Connection is made to primary through two leads passing through plated copper tubing. Since the tubing is drawn down on the leads before assembly and the tubing is soldered to the frame, the leads are permanently anchored and there is no need for terminal boards to secure their upper ends. All the coils are tuned from the top. This i-f structure provides a compact, rigid transformer that is inexpensive to build. The windings are given a double impregnation with electrical grade resin lacquer and a wax flash dip to insure stability under the extremes of temperature and humidity experienced in operation.

A 12AT7 is used as a second mixer and second oscillator. The oscillator circuit has a ceramic trimmer that provides for small adjustments of second oscillator frequency so that the receiver can be zeroed on the transmitter with which it is to operate, without realignment of the discriminator and low i-f transformers.

The low i-f amplifier has a gain potentiometer in its cathode circuit. This permits the second limiter current for noise to be set initially to the value for optimum squelch circuit action and the gain to be brought back to this level as the gain decreases over a period of time due to tube aging. This feature should prevent unnecessary tube replacements and peaking of transformers. As long as the serviceman can maintain the proper second limiter current, he will know that he does not need to touch the tubes or transformer tuning.

A differential squelch circuit is used. This type of circuit is used to give a fast transition from

squelch to no squelch. A gain control in the cathode circuit of the noise amplifier tube allows the squelch to be set to the correct level for the noise conditions that are being encountered.

Transmitter Design

The transmitter block diagram is shown in Fig 4.

With the crowded condition of this portion of the spectrum, it is necessary to limit the swing of the transmitter to ± 15 kc to prevent adjacent-channel interference. To do this, it is necessary to limit the slope, or rate of change, of the audio modulating wave. The modulation limiter employed to accomplish this slope limiting is composed of a pre-emphasis circuit, a voltage limiter, and a de-emphasis circuit, as shown in the block diagram.

The pre-emphasis circuit changes the audio input voltage into a wave whose amplitude is proportional to the slope of the audio input wave. The limiter tube is a double triode which amplifies in the first section and limits, as an overdriven amplifier, in the second section. A potentiometer in the output of this stage adjusts the point at which modulation limiting takes place. This symmetrically-limited output is fed to the de-emphasis circuit which changes the audio signal back to a wave whose amplitude is inversely proportional to the slope of the wave at the output of the limiter tube, and then to the grid of the modulator tube.

Thus, below limiting, the voltage output of the de-emphasis circuit is unchanged from the original audio input, while above limiting, the only change is that all slopes are limited to values that will prevent frequency deviation greater than desired. A visual representation of this limiting is shown in Fig. 5.

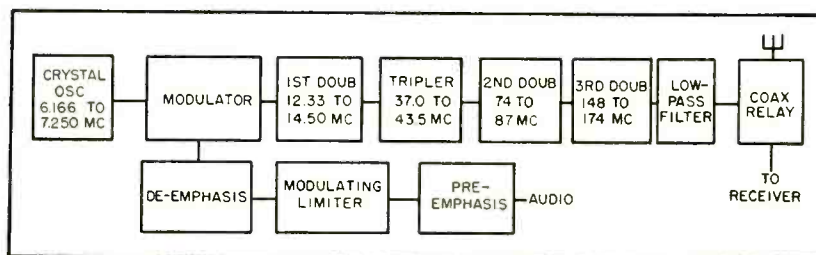

FIG. 4—Transmitter block diagram. Deviation at modulator output is ± 625 cps

The modified Pierce oscillator is capacitance coupled to the grid of the modulator tube and inductively coupled to the plate of this tube. The output of this stage is then fed to the grid of the first multiplier tube as phase modulated r-f with a maximum deviation of ± 625 cps.

As can be seen in Fig. 4, the frequency is then multiplied $2 \times 3 \times 2 \times 2$ or 24 times to the output frequency, and hence the deviation is $24 \times \pm 625$ or $\pm 15,000$ cps. Double-tuned coupling circuits are used from the tripler on to attenuate the spurious emission from the transmitter below the carrier frequency at least 70 db below the carrier output level.

The antenna circuit, which consists of a movable coupling coil with a series tuning capacitor, permits extremely simple tuning because the functions of antenna tuning and coupling are separate. The transmitter may be tuned into an an-

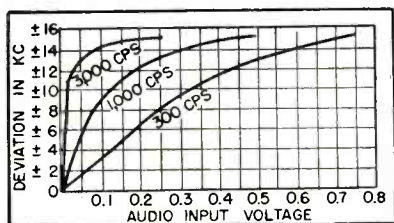

FIG. 5 — Typical modulation limiting curves for transmitter

tenna with a standing-wave ratio of 2 to 1 by merely resonating the final tank capacitor, resonating the antenna capacitor, and coupling to full power.

Field Tests

Two series of field tests were used to evaluate this equipment.

The first was conducted under conditions that might be frequently encountered in practice. It was made by using the transmissions of some of the City of Syracuse taxicab companies. Three of the companies operating on channels 5, 6, 7, are located as shown in Fig. 6A on level terrain. All of the transmitters have 50-watt output. They are equipped with high-gain antennas with gains of 2, 3 and 3, respectively at heights of approximately 105, 110, 115 feet, respectively. The receiver was tuned to channel 7 and

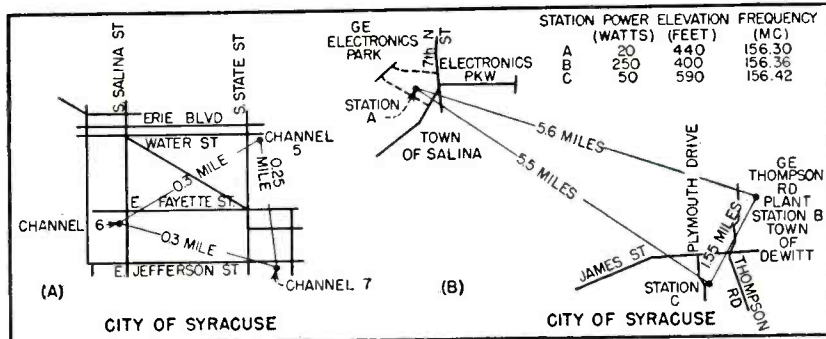

FIG. 6—Two series of field tests were made over area shown in these maps of the Syracuse area

the test car driven around the downtown area in the vicinity of the transmitter on channel 6. A number of test runs were made, and in no case was any adjacent-channel interference experienced even when the test car was in the street alongside the building upon which the channel 6 transmitter was located.

Careful checking revealed a few very restricted spots in the area around the channel 6 antenna where intermodulation interference could be heard when channels 5 and 6 were on but channel 7 was off. In every case, channel 7 completely captured as there was no trace of interference.

The second set of tests was made using special test stations on experimental frequencies.

Station A, a 20-watt station, was located at the Electronics Park Plant, elevation 406 feet, with a dipole antenna mounted on top of one of the buildings at a height of 50 feet. Station B at the Thompson Road Plant at an elevation of 400 feet, consisted of a 250-watt transmitter with a dipole antenna mounted on the roof at a height of 75 feet. Station C was a 50-watt transmitter, located on rising ground at an elevation of 590 feet, $1\frac{1}{2}$ miles from Station B. A high-gain antenna on a 38-foot mast gave station C an output equivalent to a 175-watt transmitter, and a relative height of 228 feet with respect to B.

The stations were operated on the following frequencies: A, 156.30 mc; B, 156.36 mc; C, 156.42 mc. The output of Station A was reduced to give a signal of 2 to 5 microvolts in the region of Station B, $5\frac{1}{2}$ miles away (see Fig. 6B), and tests of adjacent-channel and

intermodulation interference were made in the vicinity of Station B with a receiver tuned to Station A. These conditions were far more severe than any usually encountered in practice but were so chosen that changes in design that caused only small changes in test bench measurements could be evaluated.

Under these conditions while slight adjacent channel interference was apparent in the background of the desired signal at a distance of 1,000 feet from the antenna of Station B, the desired signal was clearly readable to within 600 feet or less, and unintelligible at 300 feet.

In the case of intermodulation interference resulting from the simultaneous transmissions of Stations B and C, although it was present in the absence of a signal from A, the latter completely captured the set up to a distance of about 800 feet from the antenna of Station B. Then there was a transition period where there was an intermingling of signals, and at approximately 600 feet, the intermodulation produced captured the receiver. The distance to Station C was approximately $1\frac{1}{2}$ miles in all cases.

These field tests proved that the design of the equipment (designated type MC203) had accomplished very satisfactorily its objectives of practical adjacent-channel operation with the maximum simplicity of circuits and lowest cost consistent with reliability and high-quality performance.

The authors wish to acknowledge their indebtedness to G. A. Kious and many others of their associates in the Radio Communication Engineering Section in the development, design and testing of the equipment.

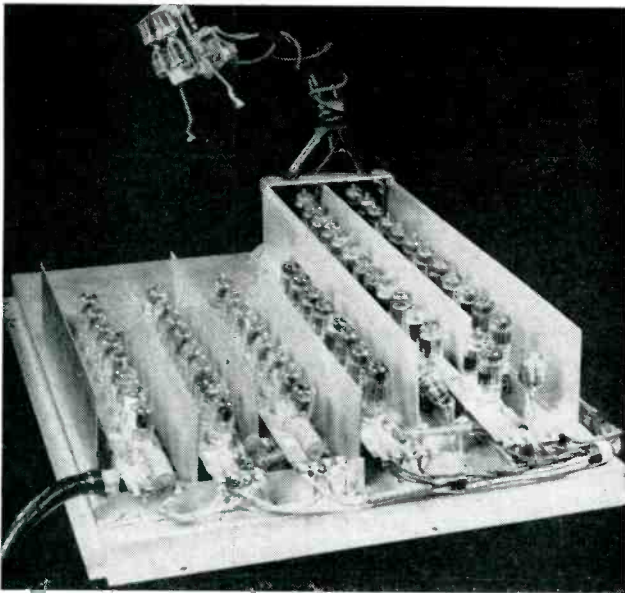

A 150-mc distributed amplifier with a gain of 5,000

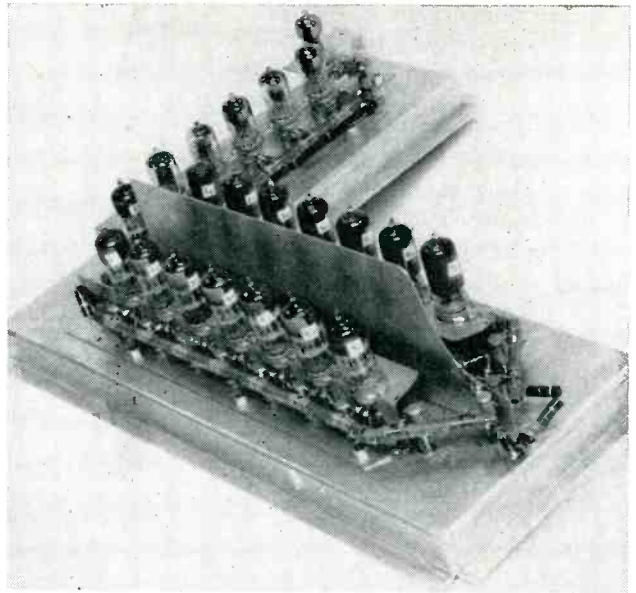

An 85-mc distributed amplifier with a gain of 180

Millimicrosecond

Pulses as short as 0.5 millimicrosecond can be viewed or recorded through use of high-gain distributed amplifiers and high-vacuum linear-sweep generators. Distributed amplifiers show promise for utilization to 500 mc or higher

By Y. P. YU

Senior Engineer
Instrument Division
Allen B. DuMont Laboratories, Inc.
Clifton, N. J.

H. E. KALLMAN and

Consulting Engineer
New York, N. Y.

P. S. CHRISTALDI

Engineering Manager
Instrument Division
Allen B. DuMont Laboratories, Inc.
Clifton, N. J.

OBSERVATION and measurement of pulses of the order of 10^{-9} to 10^{-10} sec have assumed increasing importance. This paper will discuss some recent oscillographic developments in circuits for measurement of these time intervals.

Development of high-speed sweep circuits^{1, 2}, refinements in reflection systems^{3, 4, 5, 6}, and waveform analysis using signal delay systems⁴ have been described in the literature. This paper is mainly concerned with the development of distributed amplifiers.

This article is based on a paper presented at the 1950 National Electronics Conference. The Conference paper will appear in *Proc. NEC*.

The development of amplifiers capable of satisfactory reproduction of signals containing signal components in the order of hundreds of megacycles has been hampered by the limitations imposed by practical values of transconductance, interelectrode capacitances and input loading of vacuum tubes. The suggestion of increasing effective transconductance without increasing shunt capacitance by incorporating a number of tubes into a transmission line network was made many years ago,⁸ but only recently^{9, 10, 11} has it been utilized to some degree. The principle of distributed amplification appears to

be the most promising for use with presently available tubes and components, and a number of practical designs have been evolved.

Distributed Amplifiers

Figure 1 shows the basic circuit of a distributed amplifier stage. Two artificial transmission lines are connected separately to plates and grids of the amplifier tubes, which become part of the lines. A signal voltage e_s applied to the input terminal is transmitted along the grid line to the grid of V_1 , producing a corresponding change in plate current $g_m e_s$, which is transmitted along the plate line. When

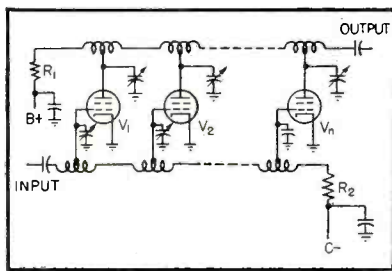

FIG. 1—Basic circuit diagram of a distributed amplifier

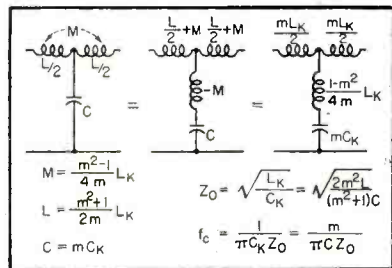

FIG. 2—Typical m -derived section and its equivalents

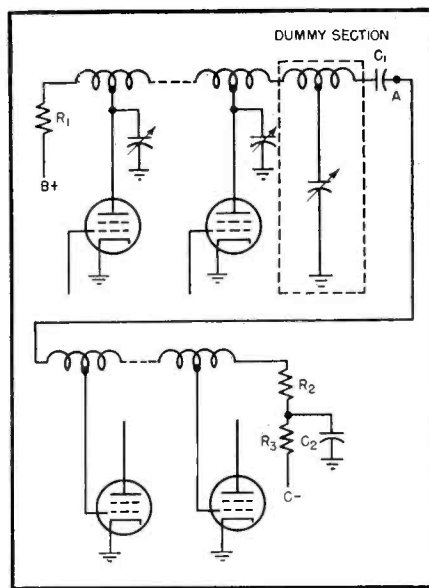

FIG. 3—Method of coupling two stages of a distributed amplifier

Oscillography

the applied signal reaches the grid of V_2 , a similar change of plate current will be produced in that tube.

If the propagation constants of these two lines are equal, the signal components of plate currents produced by various tubes will arrive at the output terminal at the same time and will add. The usual undesirable effects resulting from paralleling of tube capacitances are thereby eliminated.

When resistor R_1 is made equal to the characteristic impedance of the plate line, signal currents transmitted to the left will be completely absorbed. Similarly, the applied signal e_g will also be absorbed after the grid of V_n when R_2 is made equal to the characteristic impedance of the grid line.

Practical Considerations

For simplicity, both the grid and plate lines can be made of constant- k low-pass T-sections. However, m -derived sections have at least two advantages compared with constant- k sections. First, time delay can be made substantially constant over the entire pass band with less resulting phase dis-

ortion. Second, greater shunting capacitance can be used when m is greater than unity. This would permit either greater bandwidth or higher line impedance and correspondingly higher stage gain.

The m -derived network with substantially constant time delay up to two-thirds of the cutoff frequency is known to be that with $m = 1.27$. A typical m -derived section is shown in Fig. 2 together with its equivalents. The negative inductance $-M$ in series with the shunt capacitance C results from the aiding magnetic coupling between the two halves of L .

With L and C defined as in Fig. 2, the characteristic impedance becomes

$$Z_o = \sqrt{\frac{L_k}{C_k}} = \sqrt{\frac{2m^2 L}{(m^2 + 1) C}} \quad (1)$$

and the cutoff frequency is

$$f_c = \frac{1}{\pi C_k Z_o} = \frac{m}{\pi C Z_o} \quad (2)$$

The above expression indicates that the cutoff frequency of an m -derived section is m times that of a constant- k section.

Bridged-T networks offer the ad-

vantage of more constant characteristic impedance, but this is offset by the need for twice the number of critical circuit elements.

The signals traveling along both the grid and plate lines are subject to losses that will cause considerable attenuation at high frequencies because of the presence of impedance in the cathode circuit and the transit-time effect.

In a distributed amplifier stage the signal at the grid of the first tube is attenuated by these losses once, at the second tube grid twice, and so forth. An analysis assumes that the signal is attenuated by α db in the first section, by 2α db in the second, and so on by $n\alpha$ db in the n th section. The effective sum of all signal components of plate currents is then reduced from $ng_m e_g$ on the output of an n -tube distributed amplifier stage to $g_m e_g (a + a^2 + \dots + a^n)$, where $a = \text{antilog } \alpha/20$. The value of this sum is $g_m e_g a(1 - a^n)/(1 - a)$ and the resulting loss in db is $20 \log a(1 - a^n)/n(1 - a)$. For a typical case of $n = 7$ and $\alpha = 0.6$ db, the resulting loss is 2.5 db.

Plate Line Losses

Similar consideration may apply to losses in the plate line due to low plate impedance of some tubes, such as the type 6AN5, whose plate impedance is likely to be below 10,000 ohms. The losses so caused, are perhaps 0.5 db per stage.

Because of these losses there is obviously a limiting number of tubes per stage beyond which the amplification of the stage will decrease instead of increase. A mathematical analysis assuming 0.6-db losses per section in both grid and plate lines shows the gain increases very slowly after $n = 8$, becomes maximum when $n = 12$ and decreases thereafter. The effect of coil losses due to skin effect and other factors is small compared with tube losses, about 1 db for 40 sections of 200-ohm networks.

Other factors such as grid and plate-lead inductances result in lowering the amplifier cutoff frequency and in altering the characteristic impedance of the transmission lines. Fortunately, it is possible to minimize such undesirable effects to a small percentage

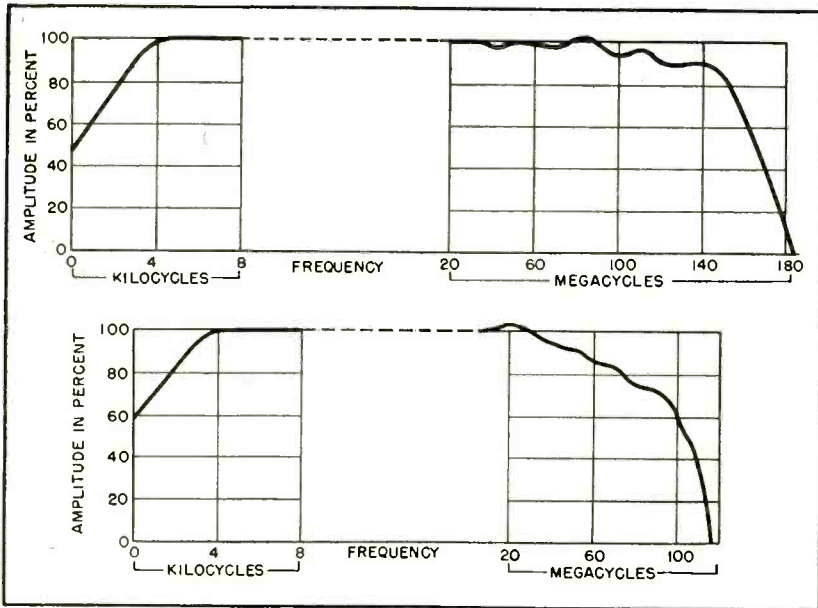

FIG. 4—Amplitude-frequency characteristics of distributed amplifier A (upper curve) and distributed amplifier B (lower curve)

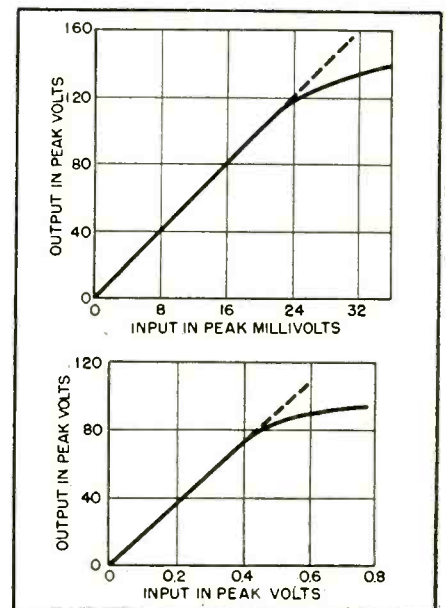

FIG. 5—Amplitude-amplitude characteristics of amplifier A (upper curve) and B (lower)

in a well-designed amplifier.

It is important to point out that uniform amplification with respect to frequency variation cannot be obtained in a stage of distributed amplification when the receiving end of the plate line is open. The reasons are: (1) The input impedance of a transmission line is no longer constant if it is not terminated by its own characteristic impedance, thus the line impedance looking at the plates of the amplifier tubes changes as the signal frequency varies; (2) The phase relations between the reflected wave and the signal components of various plate currents change as the signal frequency varies; therefore, they may add at one frequency and subtract at another.

Since the load of an oscillograph deflection amplifier is the deflecting plate of a cathode-ray tube, which is essentially a capacitive load of not less than $2 \mu\mu\text{f}$, it cannot be connected directly across the terminating resistor of the output line without introducing reflections.

To avoid this undesirable effect, an additional section is used, and the deflecting plates of the cathode-ray tube are connected as part of the shunt capacitance. This capacitance is adjusted so that the total shunting capacitance is equal to that of other sections of the same line.

For amplification of pulses, the transient response of the amplifier is important, particularly the rise time and the percentage of overshoot. In order to minimize the overshoot of a multistage amplifier, it is necessary that the phase distortion be kept very low and that the frequency response drop slowly and steadily, following the Gaussian error curve. If f_1 is the frequency at the 70-percent point of the frequency response curve, the 37-percent point should be located approximately at $1.5 f_1$. The shape of the response below 30 percent is not critical, but it also should drop slowly and steadily.

Multistage Operation

The rise time of an amplifier stage is approximately equal to the ratio of $0.35/W$, where W is the 3-db bandwidth of the amplifier. For n stages, the over-all rise time is approximately equal to the square root of the sum of the squares of those of the individual stages when the percentage of overshoot is negligible. It may be noted here that the effect of an oscillograph amplifier having rise time T_a on a signal pulse having rise time T_p can be estimated from the following expression:

$$T_{\text{resultant}} = \sqrt{T_a^2 + T_p^2} \quad (3)$$

Thus a signal pulse with a rise

time of $0.01 \mu\text{sec}$ will appear to be slowed down by 11 percent in an oscillograph amplifier with $T_a = 0.005 \mu\text{sec}$ to a resultant rise time of $0.011 \mu\text{sec}$.

Since there must always be certain physical distances existing between stages, the inductance of the leads employed for connecting stages affects the response of the amplifier. To overcome this difficulty, additional dummy sections are used. These sections serve as a continuation of the line, with tube capacitances replaced by the increased trimmer capacitances.

Distributed amplifier stages may be coupled directly in order that response may be extended down to d-c signals. For such operation, suitable means must be provided to overcome the difficulty of the presence of quiescent plate potential.¹² When d-c response is not required, the arrangement shown in Fig. 3 has been found suitable to allow signals of very low frequencies to pass with the use of standard components and without affecting the response at high frequencies. The physical size of the coupling capacitors should be kept as small as possible in order to avoid difficulties caused by both distributed capacitance and lead inductance of the coupling capacitor.

In Fig. 3, R_1 and R_2 are made equal to the characteristic imped-

ance of the line, C_1 is made equal to C_2 , and R_3 is made as large as possible for the type of amplifier tubes used. Under this condition, the impedance to the right of point A essentially equals that to the left except for the existence of a high resistance R_3 . Theoretically, the frequency response will be uniform as long as the resistance of R_3 is very large compared with the reactance of C_2 . Experimental results show that frequency response can be kept flat to as low as 200 cps even when the line impedance is 200 ohms and the coupling capacitance is only $0.01\mu\text{f}$.

Impedance transformation can be secured through the use of a stage of distributed amplification. For such operations the characteristic impedances of grid and plate lines are made respectively equal to the input and output impedances. When the stage consists of more than one tube, the propagation constants of both grid and plate lines should be made identical.

The amplification of a multistage distributed amplifier may be controlled by changing the number of

stages or by inserting attenuators. The former may offer the advantage of better frequency response and shorter rise time, while the latter has been proved to be more practical in actual cases, since it minimizes the number of plug-in connections or switches required. While stage gain can also be controlled by variation of grid bias, this method is undesirable because it seriously affects the amplitude-amplitude characteristic, producing nonlinearity.

Results

Two multistage distributed amplifiers are shown in the photographs. Amplifier A consists of six stages, four single-ended stages, a phase inverter, and a push-pull output stage. Amplifier B consists of a single-tube stage used as impedance transformation for coupling to a 50-ohm coaxial cable, a single-ended stage, a phase inverter, and a push-pull output stage.

The individual stages of amplifier A were designed to have their theoretical cutoff frequency at 250 mc and their time delay approximately

1.26×10^{-9} second, while those of amplifier B are at 125 mc and 2.52×10^{-9} second, respectively. The amplitude-frequency characteristics of these two amplifiers are shown in Fig. 4, and curves showing amplitude-amplitude characteristics of both amplifiers are shown in Fig. 5.

The rise time of amplifier A was measured to be approximately $0.004\mu\text{sec}$ and of amplifier B, $0.005\mu\text{sec}$ by the use of a special pulse generator capable of producing square pulses of $0.012\text{-}\mu\text{sec}$ duration. The upper curve of Fig. 6

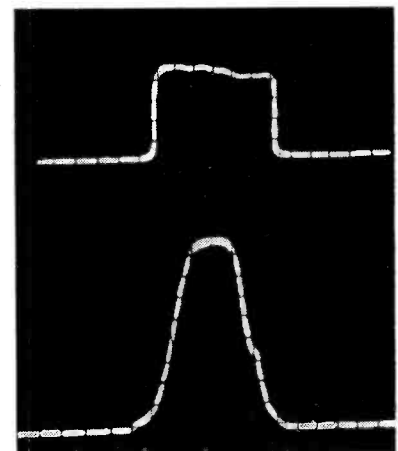

FIG. 6—Waveform of $0.012\mu\text{sec}$ test pulse applied directly to vertical deflecting plates of cathode-ray tube (upper waveform) and same pulse after transmission through a 50-db attenuator and amplifier A (lower waveform)

Table I—Technical Data for Distributed Amplifier A

Stages	Tubes	Function	Grid Line Ohms	Plate Line Ohms	Plate Current in Ma	Approx. Gain	Output Volts Peak-to-Peak
1st	8 6AK5's	Preamplifier	200	200	60	4	0.1
2nd	8 6AK5's	Preamplifier	200	200	60	4	0.4
3rd	8 6AK5's	Impedance Transformation	200	125	60	2.5	1
4th	8 6AN5's	Driver	125	125	270	6.5	6.5
5th	2 6AN5's	Phase Inverter	125	125	65	1	6.5
6th	24 6AN5's	Push-Pull Output	125	200	800	20	130
Total	58 Tubes	—	200	200	1.285 amp	5,000	130

Table II—Technical Data for Distributed Amplifier B

Stages	Tubes	Function	Grid Line Ohms	Plate Line Ohms	Plate Current in Ma	Approx. Gain	Output Volts Peak-to-Peak
1st	1 6AK5	Impedance Transformation	50	400	9	2	2
2nd	5 6AK5's	Preamplifier	400	300	45	3.8	6
3rd	1 6CB6	Phase Inverter	300	300	15	1	2.5
4th	14 6CB6's	Push-Pull Output	300	520	210	23	85
Total	21 Tubes	—	50	520	279	175	85

shows the shape of the applied pulse as it appeared on the screen of a cathode-ray tube. The lower curve shows the shape of the same pulse after transmission through a 50-db attenuator and distributed amplifier A. Amplifier A has a gain of approximately 5,000 and is capable of delivering a balanced undistorted output voltage of 130 volts peak to peak. Amplifier B has a gain of approximately 180 and its maximum undistorted output voltage is 85 volts peak to peak, balanced about ground. A tabulation of technical data for both amplifiers is given in Tables I and II.

High-Speed Sweep Circuits

Since the deflection of the cathode-ray beam is accomplished by a variation of electric field potential

between the horizontal deflecting plates, it is necessary to have this field potential changed at a rate dv/dt such that the spot will move at the required speed. For instance, a type 5XP cathode-ray tube operating with a second-anode potential of 4 kv and an intensifier potential of 25 kv requires approximately 300 volts change in electric field potential for one inch of horizontal deflection. The capacitance between these two plates, including wiring capacitance, is approximately $15 \mu\text{mf}$. The current required for a sweep speed of 400 inches per μsec becomes $I = C dv/dt = 2$ amperes. This result indicates that a tube with high current capacity is required in a high-speed sweep circuit.

The requirement of high current capacity suggests immediately the use of a thyratron but time jitter is then produced on the screen of the cathode-ray tube. Furthermore, it is difficult to operate gas-tube sweeps at repetition rates above 10,000 or even 5,000 per second because of the relatively long time required for deionization.

If a high-vacuum tube is considered for use as a switch tube it will be required to conduct between successive sweeps in a conventional circuit. For high sweep speeds it becomes difficult to find a vacuum tube that can pass 2 amperes of plate current and that has interelectrode capacitances and lead inductances small enough for the highest sweep speeds desired.

A vacuum-tube sweep circuit in which the switch tube is normally

cut off and conducts only during the time of sweep is shown in Fig. 7. In this circuit the switch tube V_5 is a vacuum tetrode type 4X150A. The lead inductances and interelectrode capacitances of this tube are quite small, yet its peak current capacity is over 2 amperes. If the repetition rate is kept under 100,000 per second, forced-air cooling of the tube is unnecessary.

Use of Tetrode

The reasons for using a tetrode instead of a triode as a switching tube are: (1) The input capacitance is substantially smaller because Miller effect is greatly minimized by the presence of a screen grid. This enables the sweep speed to become higher and simplifies somewhat the requirements of the trigger circuit. (2) Constant plate current can be obtained when the potential at the screen is made to rise or fall by the same amount as that at the cathode. Constant plate current is very important when linear sweep is required. In the circuit of Fig. 7 the potential at the screen of the switch tube is made to follow that of the cathode by the use of coupling capacitor C_4 .

Before the application of an input trigger pulse, all tubes are cut off. This results in low plate power consumption and permits the use of circuit components of low power rating.

When a trigger pulse is introduced to the grid of V_1 , plate current flows and a positive pulse is introduced at the grid of V_2 through magnetic coupling in trans-

former T_1 . Tube V_2 operates as a blocking oscillator. The time constant of R_1C_1 determines the width of the pulse produced by this blocking oscillator. The pulse is taken from the third winding of transformer T_1 to the grid of the cathode-ray tube for beam gating and to the input terminal of the delay cable for triggering the second blocking oscillator V_3 and V_4 . Use of the delay cable was found necessary in order to have the beam on at the instant when the sweep voltage starts. The time delay introduced by the cable of Fig. 7 is about $0.02 \mu\text{sec}$. Components C_2 and R_2 are employed as a differentiating circuit.

The time constant of C_3R_5 determines the width of the rectangular pulse on the grid of V_5 . Normally, tetrode V_5 is cut off, the voltage across capacitor C_5 is equal to about 2,000 volts and the voltage across C_6 is zero. During the pulse, the grid-to-cathode potential of V_5 is driven to zero or even slightly positive. Capacitor C_5 is discharged by the plate current of V_5 and capacitor C_6 is charged by the plate and screen currents of the same tube.

Since the screen-to-cathode voltage of V_5 is kept constant by the use of coupling capacitor C_4 , both plate and screen currents are expected to be essentially constant during the pulse, thus permitting substantially linear sweep voltages to be developed across C_3 and C_6 .

The value of C_5 is slightly larger than that of C_6 because the current flowing to C_5 is larger than that

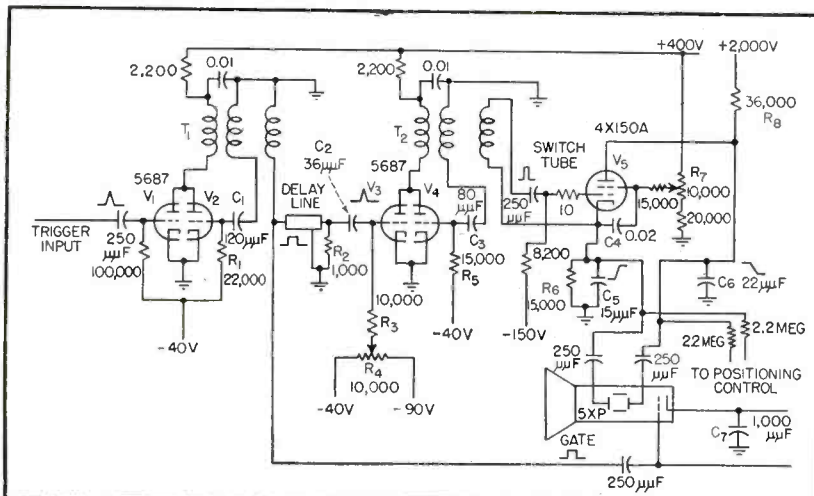

FIG. 7—Schematic diagram of high-speed sweep circuit

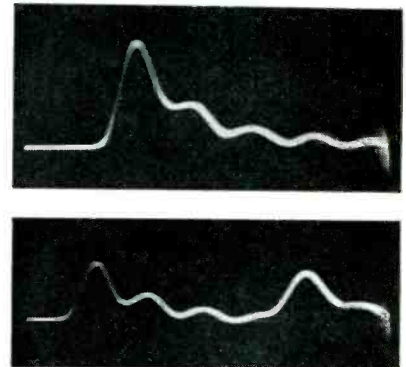

FIG. 8—Upper curve shows a 5×10^{-10} second pulse displayed on a sweep generated by the circuit of Fig. 7. Lower curve is the same pulse and its reflection produced by a 30-inch open-circuited stub of RG-58/U cable

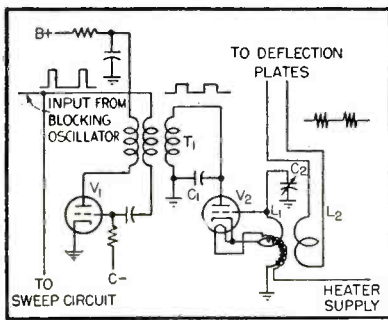

FIG. 9—Schematic diagram of high-frequency timing signal generator

flowing out from C_0 . After the pulse, tube V_0 is cut off, capacitor C_0 discharges through R_0 and capacitor C_0 charges through R_0 . The sweep speed can be changed by varying capacitors C_0 and C_1 .

Experimental Results

Experimental results show that the circuit can generate a balanced sweep voltage of about 1,500 volts peak to peak. The maximum sweep speed obtainable is over 800 inches per μsec when the sweep voltage is applied to the horizontal plates of a type 5XP cathode-ray tube with its second anode at 2,000 volts and third anode at 14 kilovolts. The speed is reduced by one-half when the second anode voltage is increased to 4,000 volts and the third anode is increased to 29 kilovolts. The sweep speed may be increased to 1,200 inches per microsecond when the sweep voltage is applied to the vertical deflecting plates of the cathode-ray tube.

The amount of time jitter is not more than the width of a normal trace on the cathode-ray tube and is estimated to be less than 0.0001 μsec . Departure from linearity was found to be less than 5 percent. The starting time from the instant of input trigger to the beginning of the sweep voltage is estimated to be 0.045 μsec . The maximum repetition rate is over 100,000 per second. The total consumption of plate and screen power is under 10 watts average.

Results of employing this sweep circuit to view a pulse signal of 0.5 millimicrosecond duration are shown in the curves Fig. 8. This pulse was generated by a circuit developed by the Purdue Research Foundation for the United States

Air Force and the Signal Corps. The oscillations at the trailing edge of the upper pulse curve of Fig. 8 were produced by the pulse generator itself, since it employs the principle of reflection to generate narrow pulses. The lower curve of Fig. 8 shows the results of connecting a 30-inch open-circuited stub of RG-58/U coaxial cable at the signal deflecting plates. This arrangement will allow an accurate calibration of the time axis. Since RG-58/U coaxial cable has a characteristic impedance of 53 ohms and a capacitance per foot of 28 μmf , the time delay will be 1.5 millimicroseconds per foot. Thus the time between the two major peaks of the lower curve of Fig. 8 is 7.5×10^{-6} second. The waveform of the pulse as shown may differ from the true waveform because of transit time effects in the cathode-ray tube and the frequency characteristic of the coaxial cable.

In order to calibrate the speed of the sweep, either a sine-wave os-

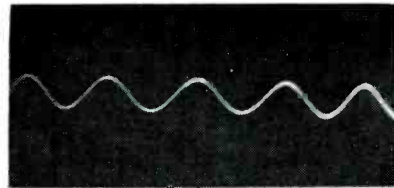

FIG. 10—A keyed 400-mc timing signal with a 2,500 prf, generated by the circuit of Fig. 9

cillator that oscillates at some known frequency or a pulse generator that produces sharp pulses at some known repetition rate can be employed to produce timing marks as vertical deflection. For sweep speeds of 400 inches per μsec , sharp pulses with rise times of less than 0.1 millimicrosecond would be required. Such pulses are difficult to generate and to apply to the deflecting plates or the control grid of the cathode-ray tube because of the leakage capacitances and inductances of all commercial circuit components involved. On the other hand, sine waves at frequencies of 1,000 mc or lower are comparatively less difficult to produce and to apply since the undesirable effects can generally be eliminated by the use of appropriate resonant circuits.

Synchronization of the timing signal to the sweep voltage is another important problem to be considered. For reasons described previously, the jitter should be less than 0.25 millimicrosecond in order to produce a satisfactory trace with a sweep speed of 400 inches per μsec . It was found that a plate-pulsed oscillator can be arranged to satisfy these requirements.

Timing Signal Generator

The schematic diagram of such a circuit is shown in Fig. 9. In this circuit, the first blocking oscillator provides a trigger pulse to the sweep circuit and at the same time serves to trigger the second blocking oscillator V_1 . The output from the third winding of transformer T_1 provides the plate current needed for oscillator tube V_2 . The heater of V_2 is raised above a-c ground potential by the use of a choke wound on the lower half of coil L_1 . This is necessary because the cathode of V_2 is above a-c ground potential. Capacitor C_2 is employed for frequency adjustment. The coupling between L_1 and L_2 should be adjusted experimentally until maximum deflection is obtained on the screen of the cathode-ray tube. Figure 10 shows the trace of a 400-mc sine wave generated by this circuit at a repetition rate of 2,500 per second on the screen of a type 5XP cathode-ray tube.

REFERENCES

- (1) D. F. Winter, "Winterscope or Fast Sweep Synchroscope", Report 1001, Radiation Laboratory, MIT, 1946.
- (2) Soller, Starr and Valley, "Cathode-Ray Tube Displays", McGraw-Hill Book Co. Inc., New York, 1948, p 288.
- (3) I. E. Lempert and R. Feldt, The 5RP Multiband Tube: An Intensifier-Type Cathode-Ray Tube for High-Voltage Operation, *Proc. IRE*, 34, p 432, June 1946.
- (4) J. V. Lebacqz, Short-time Oscillography, *Proc. NEC* 13, p 68, 1947.
- (5) A. V. Haefl, U. S. Patent 2,064,469.
- (6) M. Newman, R. P. Featherstone and P. S. Christaldi, A Cathode-Ray Oscillograph with 100-Megacycle Bandwidth, *Proc. NEC*, 4, p 445, 1948.
- (7) J. R. Pierce, Traveling Wave Oscilloscope, *ELECTRONICS*, 22, p 97, Nov. 1949.
- (8) W. S. Percival, British Patent 460,562.
- (9) E. L. Ginzton, W. R. Hewlett, J. H. Jasberg and J. D. Noe, Distributed Amplification, *Proc. IRE*, 36, p 950, August 1948.
- (10) F. Kennedy and H. G. Rudenberg, 200-Mc Traveling Wave Chain Amplifier, *ELECTRONICS*, 22, p 106, Dec. 1949.
- (11) W. W. Horton, J. H. Jasberg and J. D. Noe, Distributed Amplifiers, Practical Considerations and Experimental Results, *Proc. IRE*, 38, p 748, July 1950.
- (12) Y. P. Yu, Cathode-Follower Coupling in D-C Amplifiers, *ELECTRONICS*, 19, p 99, August 1946.

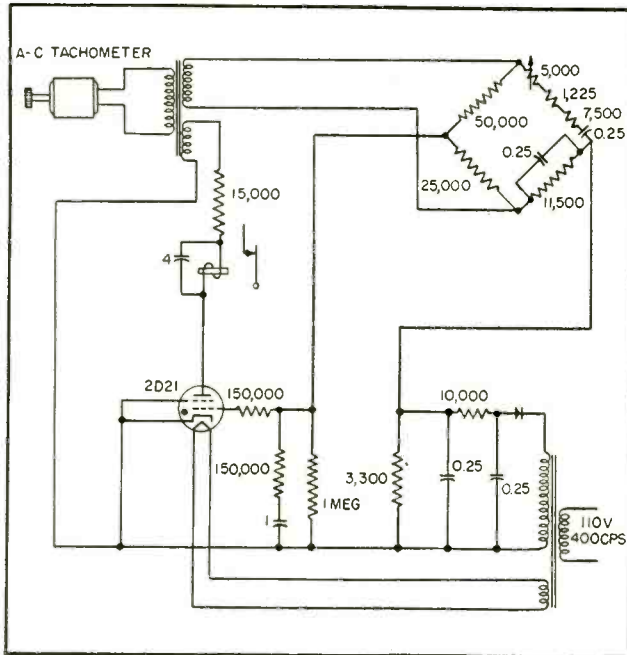

FIG. 1—Schematic diagram of electronic speed switch. The output frequency of an a-c tachometer is used as input to the frequency-sensitive network

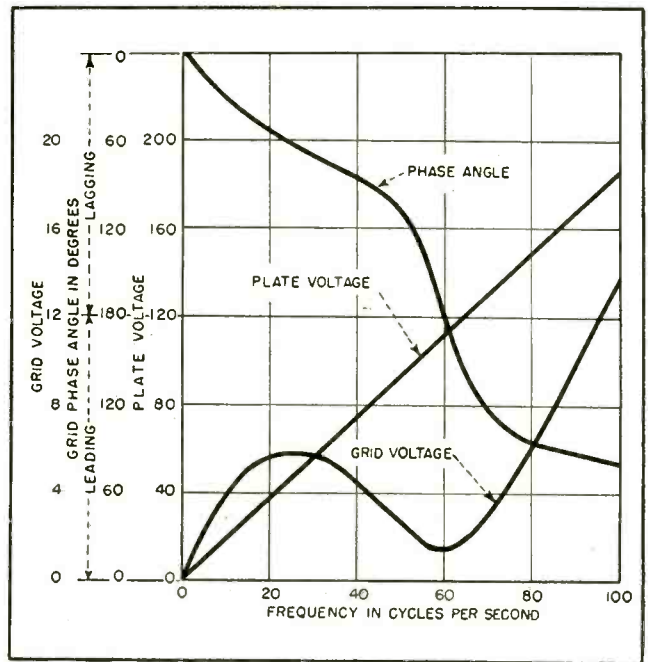

FIG. 2—Voltage and phase relationships for thyatron with Wien bridge arbitrarily balanced at 60 cps. Operating frequency of bridge is adjusted by the 5,000-ohm resistor

SPEED-CONTROLLED

Designed to operate from a standard a-c tachometer, an electronic switch makes or breaks contacts at a predetermined speed without materially increasing existing load. Switching on or off of auxiliary equipment can thus be done at the selected speed setting

SPEED CONTROL by the use of tachometers is less well known than speed measurement by the use of d-c and a-c tachometers. The simplicity of mechanical systems, such as a fly-ball governor whose output may be coupled directly to the speed-regulating mechanism, makes their use popular.

There are instances where an electrical system, particularly one using an a-c tachometer, offers distinct advantages over a mechanical system. An a-c signal whose frequency is accurately proportional to the speed of the rotating shaft can be generated without mechanical contact and brushes. In high-speed applications where gearing down to lower speeds for measuring purposes is not practical, the tachometer speed-control system may be

applied advantageously.

Remote indicators for speed are most likely to be electrical. If control signals at a certain speed are required, they can be derived from the same elements used for indication by use of a tachometer system.

Switch Operation

The electronic speed switch operates a relay at a preselected speed. The switch obtains its signal from an a-c tachometer whose output frequency is used for speed measurement. Figure 1 shows a schematic diagram of the speed switch circuit.

The tachometer output is applied through two different transformer windings to the plate of a 2D21 thyatron and to a Wien bridge. The output of the Wien bridge is con-

nected to the grid of the thyatron. A negative d-c bias prevents the thyatron from firing unless voltages of proper phase are superimposed from the output of the bridge. The sensitive double-pole double-throw d-c relay in the plate circuit becomes energized when the thyatron conducts.

Figure 2 shows the plate and grid voltages of the thyatron and their phase relationship for a Wien bridge arbitrarily balanced at 60 cycles and a tachometer voltage which rises linearly with frequency.

If the frequency of the tachometer is equal to the balance frequency of the bridge, the grid voltage is 180 degrees out of phase with the plate voltage and the tube does not conduct. As the tachometer frequency increases, the grid volt-

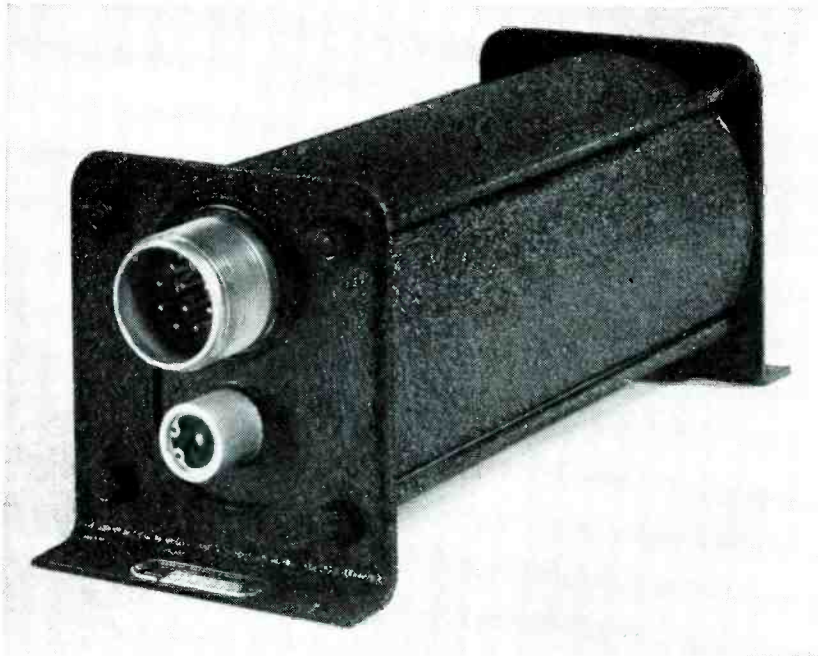

Complete switch assembly. All electrical components are hermetically sealed in one container for greater economy in size and weight. Internal parts are supported by rubber bumpers

SWITCH

By H. W. KRETSCH and F. J. WALKER

*Manning, Maxwell and Moore, Inc.
Bridgeport, Conn.*

age increases and leads the plate by an angle less than 180 degrees. Thus, somewhere at the beginning of each positive plate-voltage cycle the grid will become sufficiently positive to fire the thyatron for the balance of the half cycle and a current will flow sufficient to energize the relay.

Frequencies below the balance point will also cause a rise in the grid voltage, but in this case the grid voltage will lag the plate voltage by less than 180 degrees. The grid will be negative at the start of each positive plate-voltage cycle but will go positive at some point near the end of the half cycle. The average current created in this manner can be kept well below the value required to energize the relay.

The average current value might

become critical for very low frequencies were it not for the fact that the tachometer voltage also decreases with frequency. The relationship between grid and plate voltage at any one point can be obtained by the choice of the transformer winding feeding the bridge and plate circuit.

Even though a phase-controlled thyatron circuit has been chosen to make the operation dependent primarily on frequency, variations of the tachometer output voltage will influence the accuracy of the switch to some degree. A decrease in plate voltage, for instance, will require a larger grid voltage to fire the thyatron, as can be determined from the characteristics. To produce this larger grid voltage, a higher frequency is necessary which

in turn results in a change of the set point. For the values used in Fig. 2, a 10-percent change in tachometer voltage causes a shift of 1.2 percent in the operating point.

Line-Voltage and Temperature Effects

Line-voltage variations do not affect the operation of the switch because filament and bias voltage are both derived from the same a-c source. An increase in filament voltage decreases the operating point, opposite to the effect of an increase in bias voltage. With proper choice of the bias voltage the switch can be made independent of normal line-voltage variations.

To eliminate the influence of temperature variations, the 1,225-ohm bridge resistor is made of copper. Its value is determined so that it compensates for variations of the other bridge components and the thyatron to make the switch practically independent of ambient temperature variations.

All electric components, including the relays, are hermetically sealed into one container to protect them from altitude, temperature and humidity variations, which are quite severe in aircraft applications for which this particular model was designed. Sealing all parts into one container, rather than providing individual hermetically sealed components, gives greater economy in size and weight, which is of utmost importance for aircraft installations. The chassis is connected to the container by means of rubber bumpers which furnish the necessary shock and vibration protection. One AN type connector has prongs for the dpdt relay as well as for the tachometer and power supply. Also accessible from the outside is a rheostat permitting a change in the speed setting.

Connected between the tachometer and speed indicator of an aircraft engine, this switch will actuate its relay at a predetermined setting without interfering with the indicating system. The power drawn from the tachometer to actuate the switch is not enough to disturb the indication. It can be used to operate auxiliary equipment at the selected speed setting without mechanical connection to the engine.

Continuous FILM

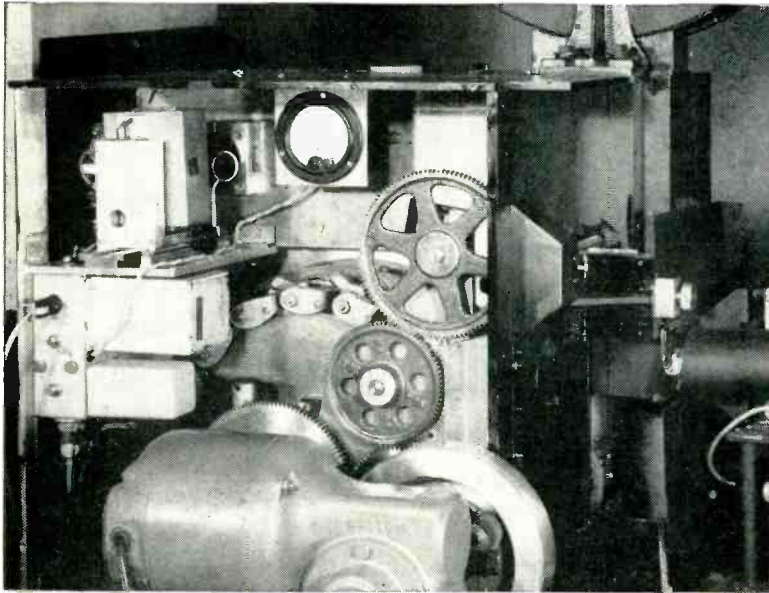

Motor drive, cam and rollers (left of center) of new projector. High precision is required on cam surface only over active angle of about 32°

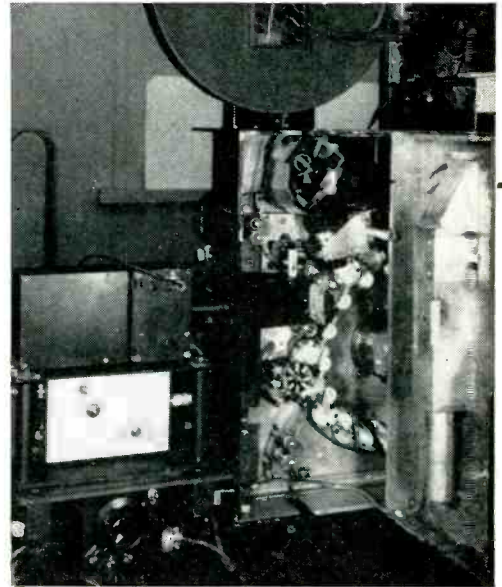

Film transport, mirrors, gate (below center) and compensating mirror (above center)

SINCE the advent of the multiplier phototube in 1938, it has been recognized that the flying-spot method of televising transparencies, using a photomultiplier as the transducer, produces a higher quality signal than do most other pickup devices. One result of this situation is the fact that film transmissions from the BBC stations in England, using the flying-spot technique and a video bandwidth of 2.75 mc, are considered by most observers to be superior to film transmissions in the United States, using the iconoscope camera and a band of 4 mc. This marked difference in quality appears, despite the wider bandwidth available to American broadcasters, because of the limitations on contrast and background inherent in the storage action of the iconoscope. American technicians have sought for the past decade for a suitable nonstorage method of televising 24-frame-per-second film on the American scanning standard of 30 frames per second. In Great Britain, the difficulty is circumvented by running the film at a speed about 4 percent above normal, at 25 frames per second, which coincides with the European scanning standard.

One such group of technicians is the television research group of the Bell Telephone Laboratories, headed by Axel G. Jensen, which has developed a number of television film scanners to serve as sources of high-quality television signals for laboratory purposes. One such projector, demonstrated in recent years, used a special form of the Farnsworth image dissector (a nonstorage device) in conjunc-

tion with specially printed motion picture film. But since special film was needed, the range of subject matter available for testing purposes was restricted. To overcome this limitation, the group decided to design a continuous film projector, similar in some respects to the German Mechau machine now used by the BBC for some of its film transmissions, but containing a number of refinements which would

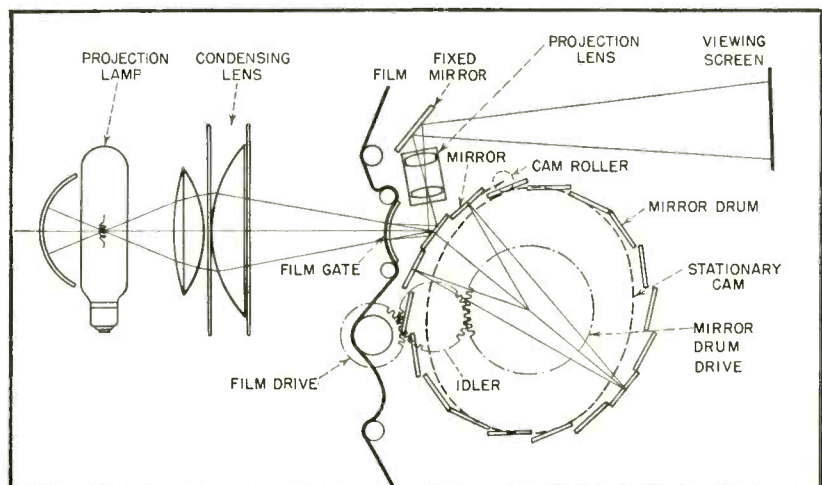

FIG. 1—Elements of projector when used for conventional projection on viewing screen. Roller attached to each mirror runs on stationary cam, turns mirror through angle to compensate for continuous motion of film past gate. Projected image contains vertical jitter and flicker

SCANNER for TV

Designed as high-fidelity television signal source by research staff of Bell Telephone Laboratories, mirror-drum projector uses two electronic servo controls to compensate for jitter and flicker, permits flying spot scanning of 24-frame film at 60 fields

adapt it to the American scanning standard and make its operation and maintenance relatively simple.

This new scanner, which is still under development, was described and demonstrated informally by Mr. Jensen and his associates before the recent convention of the SMPTE, whose members visited the Laboratories at Murray Hill on May 1. This account is derived from the information released at that meeting.

Nonintermittent Principle

Figure 1 shows the essential mechanical and optical elements of the new scanner, as it would be used for conventional projection of film on a viewing screen (rather than with a photomultiplier tube as described below). A projection lamp and condenser lens system pass light through a film gate of curved shape, over which the film passes. The film moves at constant speed, not intermittently as in conventional pulldown projectors. The image projected on the screen

would therefore be moving were it not for the fact that the optical path contains a series of mirrors in motion, their motion being such as to counteract the motion of the image.

The mirrors, eighteen in number, are mounted on the periphery of a drum or crown which rotates at constant speed, geared directly to the film drive at such a ratio that there is a crown mirror associated with each frame of the moving film. In other words, for 24 frame-per-second film, the crown rotates at 80 rpm.

Each crown mirror is free to rotate about an axis in the plane of its reflecting surface and at right angles to the plane of the diagram. Each mirror is caused to move about this axis by a lever attached to a roller, which rolls on the surface of a stationary cam. The shape of the cam is such that the motion of the mirror precisely counteracts the motion of the film, and a stationary image is thereby reflected through the projection lens to a fixed mirror and thence the viewing

screen as shown in Fig. 1.

Each mirror is active during about 32 degrees of motion. Since this is 60 percent more than the angular spacing of the crown mirrors, there is a lap dissolve of one frame into the next on the screen. In this manner, the image projected is continuous, one mirror alone being active for a portion of the time, two adjacent mirrors being active during the transition from one mirror to the next. When two mirrors are active the amount of light transmitted through the system changes somewhat, and this causes flicker at the film frame repetition rate of 24 per second. This flicker will be removed by an electronic servomechanism as described below.

Vertical Jitter

Aside from the flicker introduced by the successive action of the mirrors, this projector, in common with all other non-intermittent machines, is susceptible to vertical jitter, a slight upward and downward motion of the projected image with

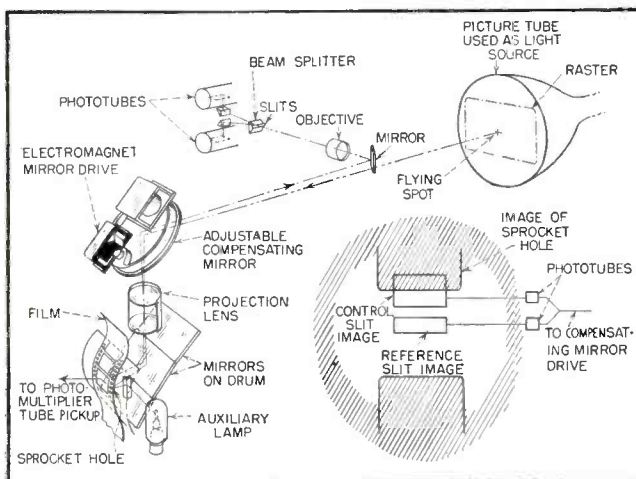

FIG. 2—Flying spot system and compensating servo which removes vertical jitter. Image of sprocket holes actuates mirror which rotates as required to compensate for any vertical motion of film frame as projected

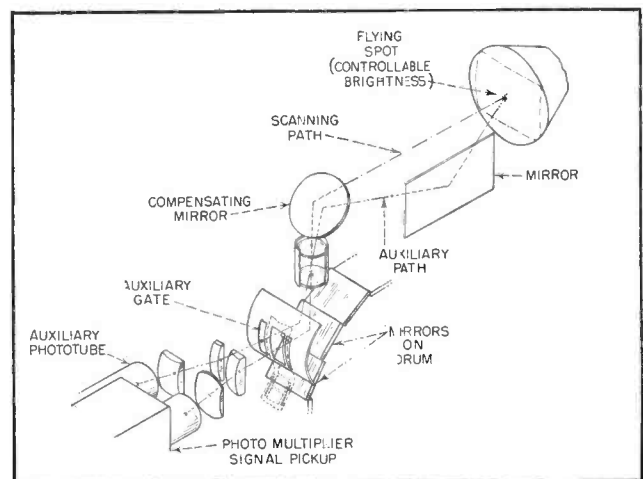

FIG. 3—Flicker-compensating servo. Light from flying spot is reflected from mirrors through auxiliary gate to phototube. Light passing through film changes through active cycle, but servo changes brightness of flying spot proportionately

respect to the frame edges. This effect arises mainly from the difficulty of maintaining absolute uniformity of film motion in the gate. This difficulty has been one of the outstanding objections to continuous projectors in the past, all of which have been found to require highly trained operators to maintain the mechanism in proper adjustment. In intermittent type projectors, this difficulty is avoided by the fact that the individual film frames are accurately aligned with the sprocket holes in the film, and these holes are accurately located, by the sprocket drive, with the respect to the film position in the gate during the dwell time of the intermittent motion. In this new projector, the vertical jitter is automatically corrected by means of an electronic servo which adjusts the position of the projected image by reference to an optical image of the sprocket holes. In addition, the servo decreases the accuracy required in the entire optical and mechanical assembly and alignment. It finally also tends to eliminate errors due to film shrinkage.

Jitter Compensation

Figure 2 shows the adaptation of the projector to the flying-spot method of pickup together with the elements of the jitter-correcting servomechanism. At the upper right is the picture tube (type 5ZP16) which serves as the source of light. The screen of this tube, which uses a very short persistence phosphor, is scanned in the usual manner (525 lines, 30 frames per second). The light from the scanning spot passes to the jitter compensating element, a front-surface plane mirror which reflects the light through a projection lens to the crown mirrors. These mirrors move past the film gate, and are turned by the cam mechanism through the proper angle to cause the spot of light to move downward with the film. The image of the raster is therefore stationary with respect to the film frame.

The light, having passed through the film, is collected and passed to a photomultiplier tube which develops a video signal amplitude proportional to the transmission factor of the film. As the scanning

proceeds, the spot moves over the whole frame in the conventional series of alternate (interlaced) scanning lines, each line being stationary with respect to the film frame.

The jitter-compensating servo begins with an auxiliary projection lamp which illuminates, through a right-angle prism, the portion of the film containing the sprocket holes. The light is reflected by the film surface surrounding the sprocket holes. Consequently an image of the area of one of the sprocket holes, in motion, is reflected back to the crown mirrors, whose rotation arrests the motion in the manner described previously. Thus a stationary image of the sprocket holes is reflected back through the system, is picked off to one side as shown, and is imaged onto a pair of slits.

The light through one of the slits is controlled by the position of the sprocket hole edge, the light through the other slit is not affected by the edge position, and serves as a reference, as shown at the lower right of the diagram. The light from the two slits is fed through prisms to two phototubes. These in turn are connected to a differential amplifier whose output is proportional to the difference in light through the two slits.

If a sprocket hole tends to get ahead of its correct position, due to jitter introduced by film or mirror drum, the light through the control slit increases and a control current of one polarity results, whereas if the sprocket hole falls behind, a current of the opposite polarity is produced. The control current, suitably amplified, is applied to a pair of electromagnets attached to the compensating mirror previously mentioned, at the left of the center of the diagram. The magnets cause the mirror to move in the proper direction and by the proper amount to shift the direction of the beams reflected by it so as to restore the edge of the sprocket hole to its proper position. This shift also corrects the direction of the beam from the flying spot to the film, and thereby maintains the raster image stationary with respect to the film frame.

The degree of compensation is

such that the vertical jitter is reduced to less than 0.1 percent of the picture height, or less than half the width of a scanning line, which is well within the usual tolerance specified for scanning systems. To achieve this performance, the servomechanism operates at high speed, and the compensating mirror moves through the required angle in a time of the order of a millisecond. Fortunately the angle through which the compensating mirror must rotate is of the order of a few minutes of arc, so the amount of driving power required is not excessive. In fact, the driving means consists of a pair of 5-inch speaker voice coil units, and the peak power is of the order of one watt.

Flicker Compensation

Figure 3 shows a servomechanism proposed to compensate for the frame flicker previously mentioned. This feature was not a part of the apparatus demonstrated but no difficulty in incorporating it in the demonstration equipment was anticipated. The light from the flying spot is picked up by a mirror at the side which reflects the beam along an auxiliary path to the compensating mirror and projection lens and thence to the crown mirrors. The two beams, one on the regular scanning path, the other on the auxiliary path, fall on the mirror surfaces side by side as shown. Consequently the intensity of the two beams changes in the same manner through the active cycle of the crown mirrors. The auxiliary beam then passes through an open gate off to the side of the film gate and into a phototube which measures the light flux in the auxiliary beam. The phototube current, suitably transduced, is then applied as a control signal on the electron gun of the flying-spot cathode-ray tube, changing the intensity of the spot by an amount sufficient to compensate for the change in the light efficiency throughout the cycle. The servo thus acts to maintain the intensity of the light passing through the film at a constant level, and the video signal variations are representative only of variations of the transmission factor of the film being televised.—D.G.F.

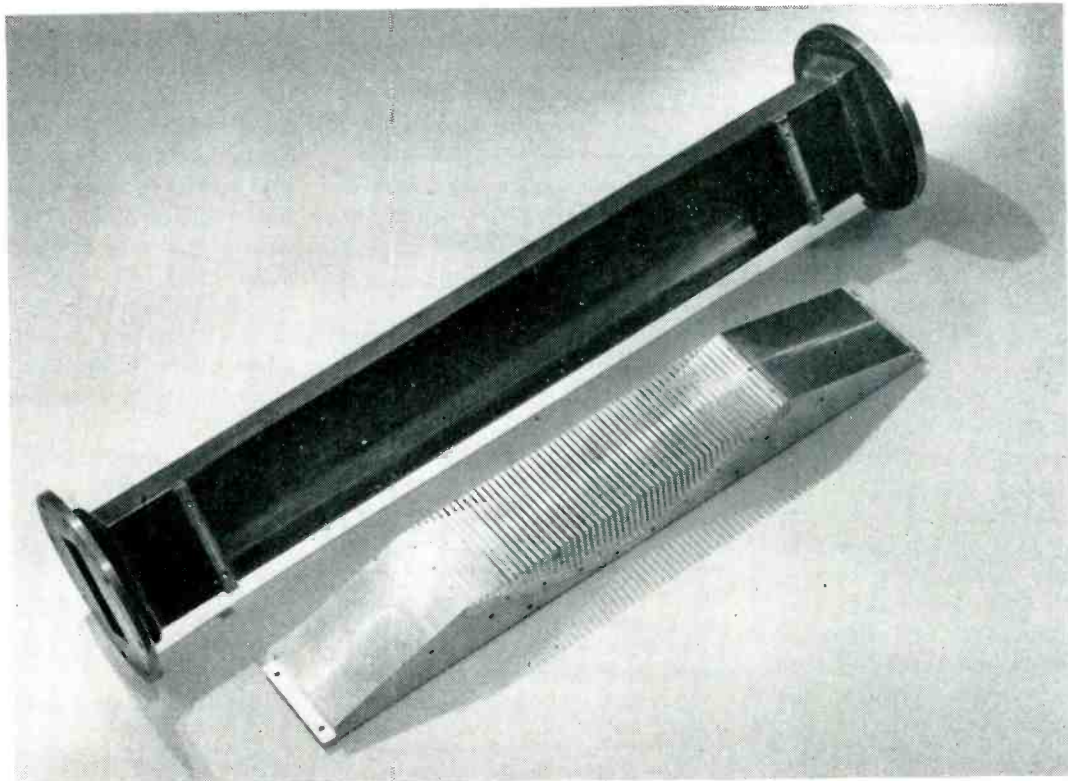

Section of waveguide and corrugated surface which fits into it

Corrugated-Waveguide Band-Pass Filters

High-pass properties of a waveguide are combined with low-pass properties of a corrugated surface in a filter designed to give a rapid transition between pass and attenuation bands. Single corrugated element does work of several elements in conventional designs

By **J. C. GREENE**

*Engineer
Airborne Instruments Laboratory
Mineola, N. Y.*

RAPID TRANSITION between pass and attenuation bands and a wide frequency range free of spurious responses are desirable properties of a band-pass filter. Such a filter can be realized readily by combining the high-pass properties of a waveguide with the low-pass property of a corrugated surface.

In a particular application a filter was designed which had a pass-

band between 2,080 mc and 2,800 mc and 70-db attenuation, relative to the pass-band response, at 2,900 mc. There were no responses which were not attenuated by at least 60 db from 2,900 mc to above 10,000 mc.

Because of the high-pass characteristic of a waveguide, a band-pass filter can be formed readily by incorporating a low-pass structure into the waveguide. One such low-

pass structure is the corrugated surface for which approximate field solutions have been given in the literature¹⁻⁴.

The design considered in this paper for utilizing the corrugated surface structure is shown in Fig. 1, where one broad face of the waveguide is replaced by a tapered corrugated surface. Approximate solutions for the attenuation and phase characteristics of the filter

in Fig. 1 are obtained by combining design relations⁵ with a loaded-line equivalent circuit representation¹.

An idealized pass-band shape is illustrated in Fig. 2. The low-frequency cutoff f_c is provided by the normal cutoff of the waveguide, while the high-frequency cutoff f_∞ , at which there is infinite attenuation, is provided by a resonance of the slots in region C of the corrugated surface.

The slots in region B of the corrugated surface serve a two-fold purpose. They provide additional resonant elements in the upper rejection band ($f > f_\infty$) to prevent repetitive pass bands. In addition they serve as a smooth taper which transforms the characteristic impedance of region C into the characteristic impedance of the waveguide through the taper in region A.

Filter Characteristics

The loaded transmission-line representation of one slot in the corrugated surface is shown in Fig. 3. The characteristic equation of the frequency spectrum relating the phase shift ϕ across one element of the loaded line (including both the slot and the transmission line of length l' to the phase shift θ along l' between two adjacent slots is

$$\cos \phi = \cos \theta - (Z/2Z_0) \sin \theta \tan (p\theta) \quad (1)$$

where $\phi = 2\pi l'/\lambda_g$
 $\theta = 2\pi l'/\lambda_g$
 $p = (b - b')/2l'$
 $Z =$ characteristic impedance of the slot
 $Z_0 =$ characteristic impedance of the unloaded line
 $\lambda_g =$ guide wavelength in the unloaded line
 $\lambda =$ free-space wavelength
 $\lambda_g =$ guide wavelength in the loaded line

λ_g is related to λ by the expression

$$\lambda_g = \lambda / \sqrt{1 - (\lambda/2a)^2} \quad (2)$$

where a is the broad dimension of the waveguide.

Putting $\phi = \beta - j\alpha$ and neglecting resistive losses one obtains for the pass band ($\alpha = 0$)

$$\cos (\beta + 2n\pi) = \cos \theta - (Z/2Z_0) \sin \theta \tan (p\theta) \quad (3)$$

where $n = 0, \pm 1, \pm 2$, etc and in the cutoff band ($\beta = 0$ or π)

$$\pm \cosh \alpha = \cos \theta - (Z/2Z_0) \sin \theta \tan (p\theta) \quad (4)$$

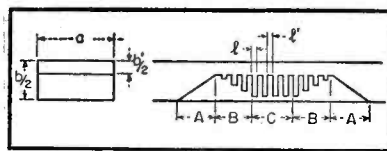

FIG. 1—Mechanical drawing of tapered corrugated surface which replaces one face of the waveguide

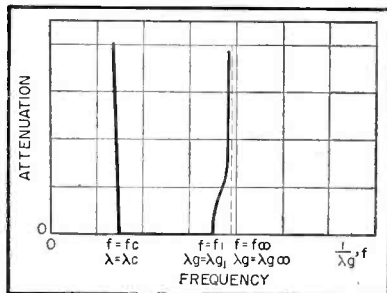

FIG. 2—Idealized pass-band shape. High-frequency attenuation at $f = \infty$ is provided by resonance of the slots in region C of corrugated surface (see Fig. 1)

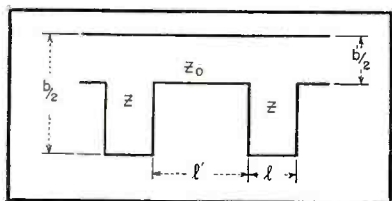

FIG. 3—Loaded transmission line representation of one slot in the corrugated surface

where $\alpha =$ attenuation in nepers per section of loaded line, $(\beta + 2n\pi) =$ phaseshift per section of loaded line.

The values of $n \neq 0$ in Eq. 3 represent space harmonics of the fundamental ($n = 0$) component of the wave. The positive values of n represent transmitted waves, the negative values reflected waves. All of these components are necessary to fully describe the propagated wave.

To simplify the analysis, the space harmonic components are neglected. This is a valid assumption in the pass band, since the amplitudes of the space harmonics are greatly reduced in the pass band⁶. The assumption becomes less valid as the frequency approaches that at which the slots become resonant.

Design relationships among the dimensions of a slot are⁵

$$b'/2 < l' < (\lambda_{g1})^2/10 \quad (5)$$

$$b'/b < 0.1 \quad (6)$$

where λ_{g1} is the guide wavelength in the unloaded section at the upper cutoff frequency, f_1 . It can be demonstrated that the pass-band resistive losses due to a finite conductivity in the conducting surfaces vary inversely with the quantity b'/b . This value was chosen to be as large as possible, namely 0.1. It may be seen from Eq. 4 that an infinite attenuation occurs when $p\theta = \pi/2$. The frequency at which this infinite attenuation occurs is f_∞ . However,

$$\theta = 2\pi l'/\lambda_g = \frac{2\pi}{\lambda_g} \frac{(b - b')}{2p}$$

Hence at the infinite attenuation frequency ($\lambda_g = \lambda_{g\infty}$)

$$p\theta_\infty = \pi/2 = \frac{2\pi}{\lambda_{g\infty}} \frac{(b - b')}{2}$$

or

$$\frac{(b - b')}{2\lambda_{g\infty}} = 1/4 \quad (7)$$

Eq. 7 means that at the infinite attenuation frequency, the slot depth, $(b - b')/2$, equals one quarter of a guide wavelength.

The values of l and l' are not critical and are generally chosen to keep the over-all length of the filter as short as possible. Typical values are $l' = 2l = 0.1\lambda_{g\infty}$. The value of the ratio Z/Z_0 is taken to be $2l/b'$, the ratio of the slot height to the line height.

Theoretical curves relating ϕ and α in db to θ are shown in Fig. 4. The curves have been calculated for $p = 2$ and $Z/Z_0 = 2$. At the point of infinite attenuation, $\theta = 45$ deg, while at the upper cutoff point $\theta = 36$ deg. Hence the ratio of the cutoff wavelength, λ_{g1} , to the infinite attenuation wavelength, $\lambda_{g\infty}$ is $\lambda_{g1}/\lambda_{g\infty} = 45 \text{ deg}/36 \text{ deg} = 1.25$. The slot requires the cutoff wavelength to be decreased by 25 percent before its attenuation becomes infinite.

Referring to Fig. 4, representing the characteristics of the slots in region C of the filter, it can be seen that repetitive pass bands will occur. The first repetitive pass band occurs when $\lambda_g = \lambda_{g1}/2$. To avoid this pass band as well as higher ones, it is necessary to include slots in region B of the filter which will resonate in the vicinity of the higher passbands. In general, this condition is fulfilled

merely by having a reasonable length of taper.

Design Procedure

The filter can be easily incorporated as an inserted section in a waveguide, with waveguide input and output. It can also be incorporated into a coaxial line through the use of waveguide to coaxial transformers. The transforming sections form the input and output of the filter.

The low-frequency cutoff determines the wide dimension of the waveguide, a , and is simply related to it by

$$\lambda_c = 2a$$

Generally, both the upper cutoff frequency f_1 and a minimum attenuation at a point between f_1 and f_∞ are specified. Once these are known, the slot depth and number of slots in region C can be determined. First λ_{g1} is calculated from the high-frequency cutoff f_1 by Eq. 2. Because $\lambda_{g1}/\lambda_g \infty = 1.25$, $\lambda_g \infty$ may be readily found. The slot depth is then made equal to $\lambda_g \infty / 4$.

The number of slots required is the desired attenuation in db at some frequency between f_1 and f_∞ divided by the attenuation of one slot at that frequency as determined from Fig. 4.

The lengths of the tapered sections in regions A and B should be about equal and as long as possible for the best match. A theoretical curve relating the vswr introduced by a taper as a function of its length has been given by Frank⁷. From this curve and a consideration of the variation in guide wavelength in the pass band, a value giving small mismatch reflections over the entire pass band is found to be $1.5 \lambda_c$ or $3a$.

Experimental Results

An experimental curve for the filter based on the previous design considerations is given in Fig. 5. The corrugated surface was designed to be inserted in standard 1.5 by 3-in. waveguide having a cutoff frequency of 2,080 mc. The desired upper cutoff frequency was 2,800 mc ($\lambda_{g1} = 16.0$ cm.) This gives the infinite attenuation frequency as 3,200 mc ($\lambda_g \infty = 12.8$ cm). It was also desired to have

at least 70 db of attenuation at 2,900 mc ($\lambda_g = 15.0$ cm).

Because λ_{g1} corresponds to $\Theta = 36$ deg on the curve of Fig. 4, at $\lambda_g = 15.0$ cm, $\Theta = 38.4$ deg. From Fig. 4, the attenuation in db per slot at $\Theta = 38.4$ deg is 9 db. Hence eight slots in region C should be sufficient to give the desired attenuation. Actually ten slots were used because the attenuation of a slot will be slightly less than shown in Fig. 4 due to resistive losses in the slot. The pass-band loss, averaging approximately 2.5 db, is a combination of resistive loss in the slots and mismatch loss in the tapers.

Higher Order Modes

In the above analysis it was assumed that only the dominant mode $TE_{1,0}$ is propagated. For the usual waveguide dimensions (broad face twice as wide as the narrow face) higher-order modes may be propagated at frequencies greater than twice the normal cutoff frequency. If these higher-order modes are propagated, spurious responses may appear in the rejection band.

Because of the symmetry of the filter, only $TE_{1,2n}$ ($n = 0, 1, 2, \dots$) and $TM_{1,2n}$ ($n = 1, 2, 3, \dots$) modes can be excited within the filter itself⁸. The first of these modes, the

$TE_{1,2}$ and the $TM_{1,2}$ will not be propagated for frequencies less than four times the normal cutoff frequency. In general this is far enough into the rejection band to be of little consequence.

Should higher-order modes, such as the $TE_{2,0}$, $TE_{3,0}$ be set up in the input section leading to the filter, they will pass through the filter and produce narrow spurious pass bands for frequencies in the vicinity of twice the normal cutoff frequency, three times this frequency, and so on.

At the cutoff frequency for the higher modes, the guide wavelength for these modes is infinite and rapidly decreases as the frequency is increased. Until the wavelength decreases to a value such that the slots in region C become resonant, no attenuation is offered to the modes.

The higher modes can often be eliminated by careful design of the input circuit to eliminate asymmetrical structures tending to excite the higher-order modes. They may also be eliminated in the output section when of a special type, such as ridged waveguide output. In this case, the ridged section is designed so that it passes the dominant mode, but is cut off for the higher-order modes in the vicinity of the spurious response pass bands. Compensating sections of different widths, a , can be included in the filter proper so that they are below cutoff for the higher-order modes over the frequency range of the spurious responses⁹.

REFERENCES

- (1) A. W. Lines, G. R. Nicoll and A. M. Woodward, Some Properties of Corrugated Waveguides, Telecommunications Research Establishment Report No. T2114; reprinted in *Proc. IEE*, 97, Part III, No. 48, July 1950.
- (2) C. C. Cutler, Electromagnetic Waves Guided by Corrugated Conducting Surfaces, Bell Telephone Laboratories Report No. MM44-160-218.
- (3) H. H. Goldstein, The Theory of Corrugated Transmission Lines and Waveguides, Rad. Lab. Report No. 494, April 1944.
- (4) S. B. Cohn, Analysis of a Wide-Band Waveguide Filter, *Proc. IRE*, 37, p 651, June 1949.
- (5) S. B. Cohn, Design Relations for the Wide-Band Waveguide Filter, *Proc. IRE*, 38, p 799, July 1950.
- (6) W. Rotman, A Study of Single-Surface Corrugated Guides, Air Force Cambridge Research Laboratory Report No. E5055, Feb. 1950.
- (7) N. H. Frank, Dielectric Structures in Waveguides, "Rad. Lab. Handbook," p 30, Feb. 1943.
- (8) Radio Research Laboratory Staff, "Very-High-Frequency Techniques," McGraw-Hill Book Co., New York, Section 27-28, 1947.

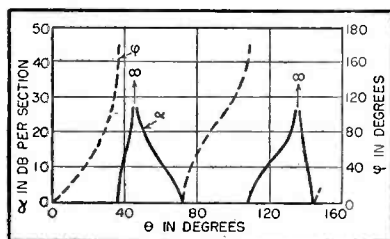

FIG. 4—Theoretical curves relating attenuation in db per section and phase shift across one slot for transmission line of length l' (see Fig. 1) to the phase shift along the distance between two slots

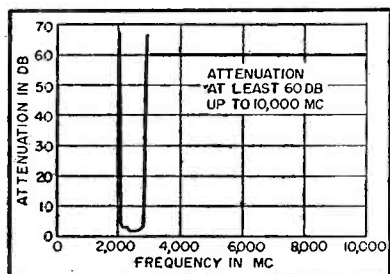
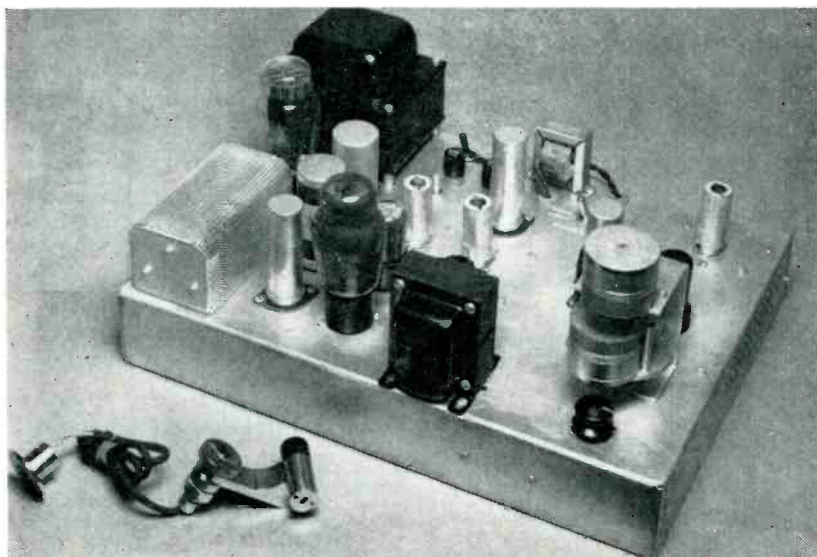

FIG. 5—Attenuation curve for actual filter constructed

BROADCAST TAPE

By D. R. ANDREWS

*Development Engineer
Radio Corp. of America
RCA Victor Div.
Camden, N. J.*



Complete equipment except for audio amplifier to drive capstan motor. Scanning unit cylinder at lower left is $\frac{3}{4}$ inch in diameter and 2 inches long

utilizes optical markings to furnish the timing signal. Since the signal markings are not magnetic, no unwanted signal is generated in the reproducing head by the additional information stored on the recording medium.

The signal is produced by equally spaced bars, printed on the reverse side of the tape, as they are scanned with an optical transducer. This transducer comprises an extremely simple optical system. A grid, placed directly over the printed side of the tape, consists of a mask with one or more holes to correspond with the markings on the tape. A light source is directed towards the grid and as the tape changes in color beneath the hole in the grid, more or less light is reflected back into a photocell.

Figure 1 shows a cut-away view of a scanner to illustrate the operation of such an optical system. Part of the light from source *B* goes through the aperture or grid *C* onto the tape *A*. The intensity of the light reflected back to the photocell *D* is partially governed by the color and gloss of the tape surface. The printed markings therefore produce a signal in the photocell whose frequency is directly proportional to the speed of the tape past the aperture.

The signal generated by the motion of the tape must be compared with some standard or reference frequency, which may be obtained from a regular power supply or from a stable clock-circuit power supply. Some large broadcasting studios have the latter to insure the accuracy of clocks used for program timing. Since available clock motors are designed to operate on 60 cps and the NAB standard tape speed is fifteen inches per second,

THE MANY conveniences of magnetic tape as a medium for recording radio programs are attractive to producers and artists, as well as broadcast technicians. A complete show can now be recorded in a manner similar to the production of a Hollywood movie, with each selection recorded over and over until the director is entirely satisfied. The producer can then edit the recordings to produce precisely the type of show he desires. Fluffs may be easily removed and replaced. This practice provides a freedom of expression for the artist that is extremely convenient. During the editing process the show can be carefully timed so that it will be completed without sacrificing valuable commercial time.

To insure desirable continuity, the program must be timed within one second in a half hour. The dimensional stability of plastic-base tape is not sufficient to guarantee that the recorded time will be maintained to such close tolerances during reproduction of the program.

Conditions of temperature and humidity as well as tension affect the physical dimensions of plastic materials. These dimensional changes may increase with time.

Therefore, programs that are shipped to other locations having different climatic conditions or those stored for long periods of time may suffer severely in this respect. In such cases, the time required for reproducing the program may vary considerably from the recording time.

Timing Controls

Several different methods of controlling the playing time of tape recordings have been suggested or tried. One utilizes transverse magnetization to record a reference signal on the tape during the recording of the program.¹ This effect is accomplished by rotating the signal recording head 90 degrees so that the gap is placed parallel to the direction of tape travel. The signal recorded in this manner is reproduced during playback by a similarly oriented head and is used for synchronizing purposes.

A second system² makes use of a 14-kc carrier that is modulated with a timing signal. During reproduction, the carrier is filtered from the program signal and after demodulation is used for synchronization.

The system we have developed

SPEED CONTROL

Magnetic-tape programs can be played back within less than a second of original half-hour recording time despite 2-percent stretch or shrink. Printed bars on back of tape are scanned photoelectrically to produce a comparison signal that is held at exactly 60 cps

the markings on the tape are placed at four bars per inch. If it is desirable to operate the tape at the secondary standard of 7.5 inches per second, the marking of four bars per inch may still be used to produce a 60-cps signal by means of a frequency-doubling circuit.

Comparing Speeds

Several methods of comparison between reference and photocell frequencies could have been used. One utilizes a simple beat note for driving the capstan motor. The signal from the photocell is mixed with a signal of twice the reference frequency and the beat note produced will then vary in frequency inversely with the frequency of the photocell signal. This system decreases the error but can never introduce sufficient compensation for complete correction.

A second method uses a two-phase motor as an integrator. The

signal from the reference frequency is used to furnish power for one winding of a two-phase capstan motor. The signal furnished by the motion of the tape is amplified to excite the second winding of the motor. If the phase of the current through the first winding leads that of the current in the second winding, the torque of the motor is increased, and conversely, if the phase of the current through the second winding leads that of the current in the first winding, the torque of the motor is decreased. Such a system, however, is an instantaneous or phase-integrating device and does not furnish the time-integrating system desirable for broadcast timing.

Small, fast deviations may produce extremely high percentages of wow. This fact makes it imperative that any correction in speed be accomplished at a very slow rate.

A third method providing a slow

time-integrating device may be designed using two synchronous clock motors. One operates from the clock power supply, using no more than 4 watts from this source. A second clock motor operates from the signal generated by the photocell, with rotation counter to that of the first motor. The shafts of the two clock motors are joined by a flexible coupling. As long as the two frequencies governing the speed of the two motors are identical nothing happens, but any difference in the two frequencies causes the frame of one of the motors to rotate with respect to the frame of the second one. This might be described as a simple mechanical differential, which needs no special gears or precision parts.

Capstan Speed Correction

The rotation of the clock frame may be utilized in a number of different ways to obtain correction of

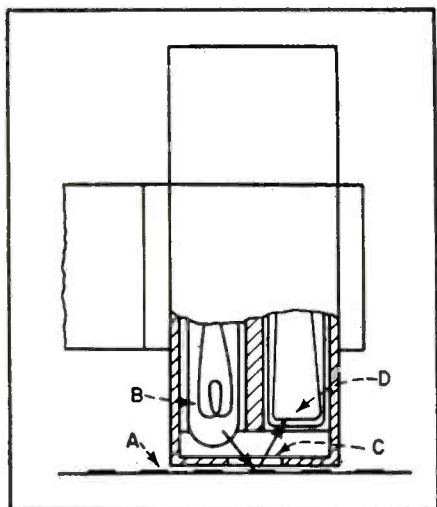

FIG. 1—Light from lamp B reaches photocell D by reflection from tape A

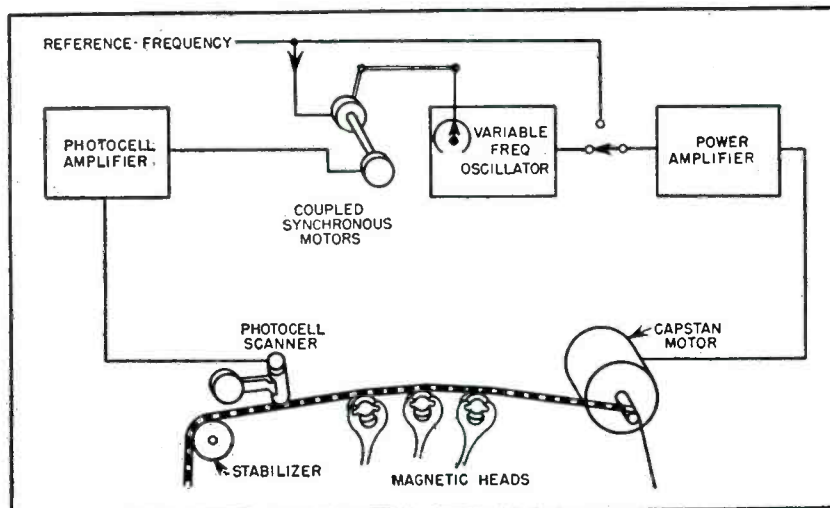

FIG. 2—Block diagram of the final system in which closed-circuit servo operates capstan motor so that signal from tape is exactly 60 cps

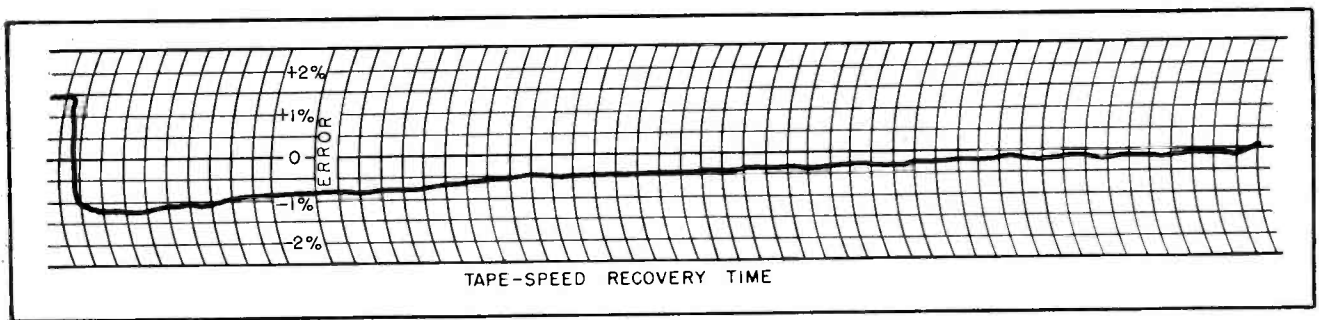

FIG. 4—Recovery time after drastic intentional error was introduced into the system

mately $\frac{1}{4}$ -inch cube). The lead sulphide type was chosen also because of its sensitivity at the red end of the visible spectrum.

Since all the better quality plastic-base tapes are coated with ferric oxide, their color is a reddish brown. The markings can be printed on this color with black ink and produce good contrast when scanned with a red-sensitive photocell. If black tape is used with white markings, the contrast is also sufficient with the same photocell.

The lead sulphide photocell has an internal resistance that varies inversely with the light applied to its sensitive area. The circuit requires a voltage supplied through a load resistance or inductance in the same manner as the anode of a vacuum tube.

The output from the photocell is fed to a conventional preamplifier (Fig. 3A). If the tape is being operated at half speed or 7.5 inches per sec, the signal is diverted through a frequency-doubling circuit (Fig. 3B). This circuit consists of an amplifier, to regain the losses caused by the other stages; an isolation stage, to provide balanced input for the bridge; and a full-wave bridge-type rectifier, to provide the frequency doubling. The gain of the amplifier is so adjusted that the output signal has approximately the same level as that of the input but at twice the frequency.

The output from the frequency-doubling circuit or preamplifier, as the case may be, is passed through a limiter or clipper circuit (Fig. 3C). This circuit provides an output of constant amplitude even though the input signal may vary as much as five to one.

The output from the clipping cir-

cuit is then amplified sufficiently to operate one of the clock motors (Fig. 3D). Since the signal is changed to approximately a square wave in the clipping circuit, it is necessary to reshape the signal in the amplifier circuits. A nearly sinusoidal signal is provided by resistance-capacitance filters as well as by a capacitor tuning the inductance of the clock motor itself. Changes in the waveform of the signal are indicated on different sections of the diagram. Signals from the photocell and preamplifier are shown for a tape speed of 15 in. per second.

Control Relay

The relay that stops the clock motors and switches the signal for the capstan motor is electronically controlled (Fig. 3E). The coil is in series with the cathode circuit of a thyatron tube and the relay is normally energized. When the grid of the thyatron is biased negatively, the tube is cut off and the relay is deenergized.

Bias for the thyatron is furnished by rectifying some of the signal generated by the photocell. The signal is furnished to the diode rectifier through a high-pass filter network from the output of the power amplifier stage. This filter network may be adjusted so the relay will become de-energized as the frequency of the photocell signal approaches 60 cps.

The variable-frequency oscillator (Fig. 3F), furnishing the signal for the capstan motor, uses an R-C circuit of the phase-shift type. Three R-C phase-shifting elements are used, with each unit shifting the phase approximately 60 degrees. One of the resistance elements is varied with the motion developed by the dual clock-motor

differential, and so drifts the frequency of the oscillator.

It may be noted that the impedances of the R-C circuits are kept as low as possible. This precaution was used to decrease the possibility of hum pickup in the grid circuit. Any oscillator has a tendency to lock-in on any signal appearing on the grid of the tube. If lock-in occurs, the usefulness of the entire system will be jeopardized.

No circuit is shown for the power amplifier needed to drive the capstan motor. A conventional audio power amplifier may be used or a much simpler narrow-band amplifier could be constructed.

Performance

Repeated timing tests have been made with this synchronizing system. A synchronized tape was recorded with timing markers exactly 15 minutes apart. Reproduction of this tape was again timed. The timer was operated from the same source of power as that furnishing the reference frequency in both cases. The greatest differential between recording and reproducing time in several tests was 0.3 second. This error might be reduced still further at the expense of speed variation or wow. A recovery rate was selected so that any speed changes would occur as slow drift and not be detected as wow.

The curve in Fig. 4 depicts the recovery rate of tape speed after an intentional error that had been introduced into the correcting device by manually rotating the clock-motor differential.

REFERENCES

- (1) R. H. Ranger, Sprocketless synchronous magnetic tape, *Jour. SMPTE*, Mar. 1950.
- (2) D. G. C. Hare & W. D. Fling, Picture-synchronous magnetic tape recording, *Jour. SMPTE*, May 1950.

Measuring Vector Relationships

Imaginary and real components of an unknown voltage in terms of a reference voltage are indicated directly over a frequency range of 8 cycles to 500 mc. Other applications include study of phase delay in amplifiers, wave filters and attenuators

By Y. P. YU

Passaic, N. J.

VECTOR RELATIONS of alternating voltages over a wide frequency range, from 8 cycles to 500 megacycles, can be measured by means of the instrument to be described. In most applications, the operating principle is based essentially on the vector theory of addition and subtraction. The operating principles underlying two frequent applications, measurement of the phase angle between two given voltages and measurement of complex components of an unknown voltage, will be discussed.

Phase-Angle Measurement

Figure 1 shows a block diagram of the instrument as it is used for the measurement of the phase angle between two given voltages, E_1 and E_2 . Variable attenuators R_1 and R_2 are used for adjusting the amplitudes of E_1 and E_2 . Phase inverters P_1 and P_2 are capable of producing a constant phase shift of 180 degrees over the entire range of operating frequency.

When terminals 4 and 8 are connected to terminals 1 and 6 respectively, output meter V will read the vector difference of E_1' and E_2' . If the absolute amplitudes of E_1' and E_2' are made equal by adjusting R_1 and R_2 , the reading E_o on the output meter may be expressed as

$$E_o = E_2' - E_1' \\ = |E_1'| (\cos \theta + j \sin \theta - 1) \quad (1)$$

where θ is the phase angle between

E_1 and E_2 . The absolute magnitude of E_o may be written as

$$|E_o| = |E_1'| \sqrt{(\cos \theta - 1)^2 + \sin^2 \theta} \\ = 2 |E_1'| \sin \frac{\theta}{2} \quad (2)$$

For simplicity, the magnitude of $|E_1'|$ is made equal to one volt dur-

ing adjustment of attenuator R_1 , whereby the term $|E_1'|$ may be omitted in Eq. 2, and

$$|E_o| = 2 \sin \frac{\theta}{2}$$

The output meter may be calibrated to indicate directly the phase angle in degrees between any two voltages. For instance, a meter with full-scale sensitivity of two volts will read 60 degrees at its center and 180 degrees at full scale.

The distribution of readings on a meter face is an important factor in the design of measuring instruments. A linear-scale meter which has a guarantee of one percent error at full scale would produce an error of 10 percent at one-tenth full scale. Sinusoidal distribution of meter readings is a desirable feature since the percentage accuracy of readings is nearly uniform over the entire scale.

Where the two voltages under consideration are nearly opposite in phase, the accuracy of reading can be greatly increased by introducing a phase shift of 180 degrees to either one. This is done with phase inverter P_1 or P_2 . A second scale starting with 180 degrees at its normal zero position is established.

Without altering the value of any circuit element the full-scale sensitivity may be increased to any value between 0 and 180 degrees or between 180 and 360 degrees by increasing the value of $|E_1'|$.

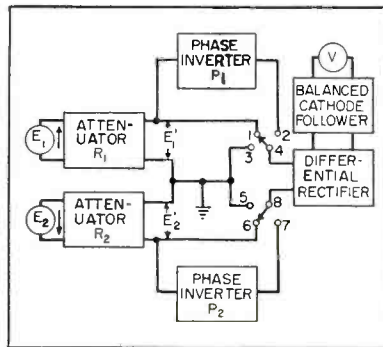

FIG. 1—Block diagram of the Vector-lyzer

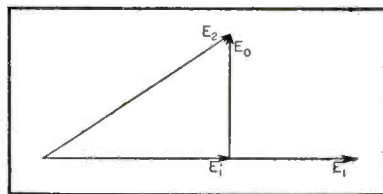
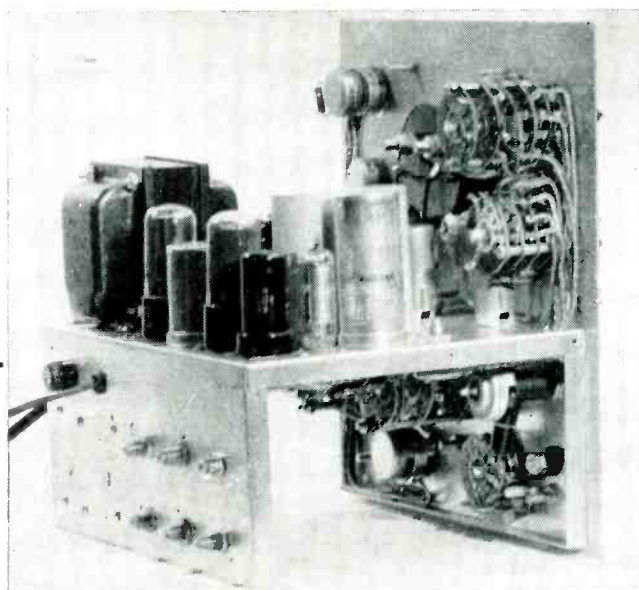

FIG. 2—Vector diagram used in connection with measurement of complex components of an unknown voltage



Instrument chassis with cover removed



Front-panel view of the complete instrument

The principle underlying this feasibility can best be explained by referring to Eq. 2. As the phase angle θ of this equation decreases, the magnitude of the resultant voltage $|E_o|$ may be held constant if the amplitudes of the input voltages increase accordingly. This in turn keeps the indication on the output meter unchanged, since it is energized by the resultant voltage $|E_o|$.

If it is desired to increase the full-scale angular sensitivity of the instrument from 180 degrees to 60 degrees with the voltage sensitivity of the output meter remaining at 2 volts, R_1 and R_2 are readjusted so that the magnitudes of $|E'_1|$ and $|E'_2|$ will be two volts instead of one volt. After this readjustment the angular sensitivity of the output meter will be increased by three times.

Measuring Complex Voltages

The instrument is a simple and convenient device for direct indication of the imaginary and real components of an unknown voltage in terms of a reference voltage. The block diagram of Fig. 1 may also be used to explain the operating principle underlying this application.

In Fig. 1, E_1 and E_2 are assumed to be the reference and unknown voltages respectively. Attenuator R_2 is adjusted to give zero attenuation so that E'_2 will be equal to E_2 .

Attenuator R_1 is adjusted until the deflection at the output meter reaches a minimum with terminals 4 and 8 connected respectively to terminals 1 and 6. To represent this condition, a vector diagram is drawn in Fig. 2 for voltages E'_1 , E_2 , and E_o . Symbol E_o denotes the reading on output meter V , which is also the potential developed across terminals 1 and 6 when the meter is correctly calibrated.

Since these three vectors form a right triangle, the diagram indicates that E_o is equal to the imaginary component of E_2 and that E'_1 is equal to the real component of E_2 . The output meter will read directly the imaginary component with terminals 4 and 8 connected to the positions shown in Fig. 1 and read directly the real component when terminal 8 is connected to terminal 5.

If the phase angle between the unknown voltage and the reference voltage is greater than 90 degrees but less than 270 degrees, the above method of measuring complex components still is useful when E'_1 is shifted 180 degrees with respect to E_1 by inserting phase inverter P_1 .

High-Impedance Attenuator

The attenuator circuit shown in Fig. 3 is designed to minimize phase-distortion difficulties encountered with conventional volume controls at high frequencies. The tri-

ode is arranged as a cathode follower to provide a high input impedance and to allow the resistance of the potentiometer at its cathode to become very low. The first feature is essential for many practical applications while the second helps to minimize the error caused by the stray capacitances of the potentiometer.

Experimental results show that the maximum error introduced by the circuit of Fig. 3 is less than 2 degrees at 2.5 mc with a 1,000-ohm carbon potentiometer for R_3 . At low frequencies, the error angle is determined by the values of C_2 and R_3 —the larger these two elements are, the smaller the error angle. Capacitor C_2 keeps the d-c potential constant at the output terminal during adjustment.

Figure 4 shows the schematic diagram of the differential rectifier and the balanced cathode-follower circuits appearing in Fig. 1. Diode V_1 functions as a differential rectifier. During the positive loop of the applied voltage, C_1 and C_2 charge through V_1 . During the negative loop of the applied voltage these two capacitors discharge through the series combination of R_1 , R_2 and the other part of the circuit.

The time constant during discharge is made very large compared with that during charge, and therefore the sum of the average poten-

tials across C_1 and C_2 is only slightly less than the peak value of the positive loop of the applied voltage. Resistors R_1 and R_2 are used to isolate both input terminals from the other part of the circuit. Both input terminals can be connected to points which are above a-c ground potential.

Triodes V_2 and V_3 function as a balanced cathode follower. The impedance between points C and D looking into the cathode follower is $R_3/(1 - A)$, where A is the gain of the cathode follower. This impedance becomes very large compared with R_3 when A approaches unity. In practice, the value of $R_3/(1 - A)$ can be conveniently made equal to 100 megohms or higher if R_3 is chosen to be 10 megohms. This high impedance makes it possible to operate the instrument at frequencies as low as a few cycles since the time constant $[C_1 C_2 / (C_1 + C_2)] [R_3 / (1 - A)]$ determines the lower limit of the frequency response.

Another feature of the circuits described is good stability. This is achieved by the use of balanced arrangement. Physically, R_5 , R_6 , V_1 , V_2 and V_3 - V_4 perform as four arms of a balanced bridge in which R_5 and R_6 correspond to the ratio arms, V_1 - V_2 to the unknown arm and V_3 - V_4 to the standard arm.

VHF Operation

With available circuit elements and technical knowledge it is extremely difficult to construct a variable attenuator which will produce negligible or constant phase shift from 10 to 500 mc while also having a high input impedance. It is equally difficult to construct a high-impedance network which will introduce a constant phase shift over this range.

Figure 5 shows the basic circuit of the instrument when it is used at high frequencies. In this circuit, rectification is performed by the probe which consists of a germanium crystal, two capacitors and two resistors. The resonant frequency of the probe can be made very high, over 700 mc, when care is taken during construction. Potentiometer R_4 is used for panel zero adjustment. Before operation the variable arms of potentiometers

R_5 and R_6 are set at their extreme right positions.

In order to explain the operation of this circuit, consider the case of measuring the phase angle between two given voltages. Assume that symbols E_1 and E_2 represent the two given voltages and the magnitude of E_1 is smaller than that of E_2 . The procedure for handling various controls is as follows: (1) Connect input terminal 6 to ground and connect terminals 4 and 5 to terminals 1 and 2, respectively. Adjust potentiometer R_3 until a half-scale deflection is obtained on the output meter. This step serves to adjust the sensitivity of the instrument so that a full-scale deflection will occur if the phase angle to be measured is 180 degrees. (2) Connect terminal 4 to ground and terminal 6 back to terminal 3, then adjust potentiometer R_6 until a half-scale deflection is again obtained on the output meter. This step serves to adjust the zero indication of the instrument so that the output meter will read zero when the two input voltages are in phase. (3) Connect terminal 4 back to terminal 1. Now enter the reading of the output meter into one of the curves of Fig. 6 and find the answer on the X axis. If the absolute magnitudes of both input voltages are equal, the phase angle can be read directly on the output meter and it is possible to omit both the second step and the use of the curves of Fig. 6.

To explain the operating principle, an expression for the voltage E_o developed across terminals 1 and 6, which is also the reading on the output meter, is written as follows:

$$E_o = E_2 - E_1 = |E_1|(n \cos \theta + j n \sin \theta - 1) \quad (3)$$

where $n = |E_2|/|E_1|$ and θ is the phase angle between E_1 and E_2 . The absolute amplitude of E_o is

$$|E_o| = |E_1| \sqrt{n^2 + 1 - 2n \cos \theta} \quad (4)$$

Equation 4 indicates that $|E_o|$ varies from $(n - 1)|E_1|$ to $(n + 1)|E_1|$ as the angle θ varies from zero to 180 degrees. Thus the maximum variation is $2|E_1|$ which is independent of the ratio n . This relation is very important in using the instrument at high frequencies.

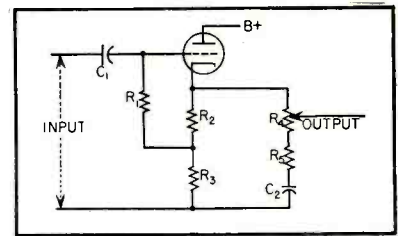

FIG. 3—Basic circuit diagram of the attenuator for audio and radio frequencies

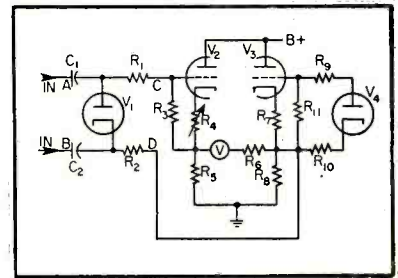

FIG. 4—Differential rectifier and balanced cathode follower

Assume that θ_1 is the reading of the output meter and θ is the true phase angle between E_1 and E_2 . Since the scale of the output meter is calibrated in degrees for the case when both input voltages have equal amplitude, we may write

$$2|E_1| \sin \frac{\theta_1}{2} = |E_1| [\sqrt{n^2 + 1 - 2n \cos \theta} - (n - 1)] \quad (5)$$

In Eq. 5, the term at the left is obtained by substituting $n = 1$ into Eq. 3, while the term at the right is derived from Eq. 4 and the fact that a voltage with amplitude equal to $(n - 1)|E_1|$ is balanced out from the output meter during the second step of adjustment. By rearrangement of terms, Eq. 5 becomes

$$\cos \theta = 2 \left(1 - \sin \frac{\theta_1}{2} \right) \left(1 + \frac{1}{n} \sin \frac{\theta_1}{2} \right) - 1 \quad (6)$$

Graphical representation of Eq. 6 is shown in Fig. 6.

Complete Instrument

A simplified circuit diagram of the complete instrument is shown in Fig. 7. Essentially the instrument is a combination of the following elements: two variable attenuators, two phase inverters, a differential rectifier, a balanced cathode follower, a high-frequency probe,

SQUARE-WAVE GENERATOR

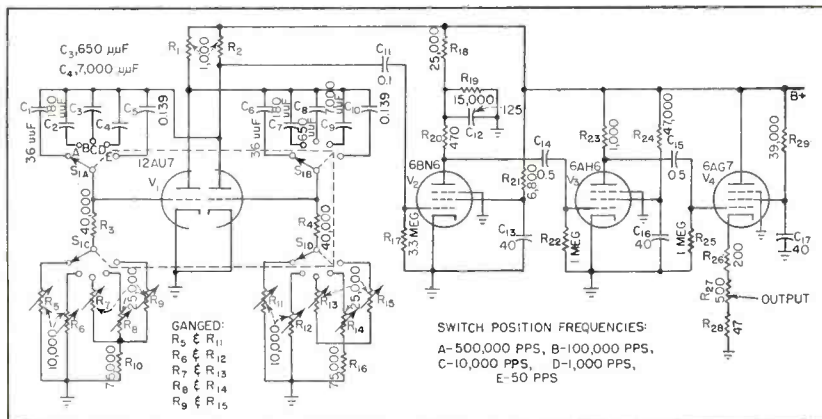

FIG. 1—Circuit diagram for square-wave generator. The clipper stage employs a 6BN6 gated-beam tube

By LOUIS E. GARNER, JR.

Technical Consultant
National Radio Institute
Washington, D. C.

MOST SQUARE-WAVE generators are fairly expensive because they employ several cascaded amplifier stages to provide adequate clipping action. With only five tubes used in the complete instrument, a square-wave generator using a 6BN6 gated-beam tube as a clipper¹ delivers a signal with good waveform, fast rise time and wide frequency range. The schematic diagram of such an instrument is shown in Fig. 1.

Circuit Description

Referring to the schematic diagram of Fig. 1, a 12AU7 twin-triode, V_1 , is used as a plate-coupled symmetrical multivibrator. Five separate frequencies of operation are provided with each frequency obtained by changing the grid-plate R-C circuits by means of switch S_1 . The grid resistors are dual potentiometers which can be adjusted to supply exact frequencies on each switch position regardless of coupling-capacitor tolerances.

The nonsinusoidal signal appearing across plate load R_2 is applied through C_{11} to the gated-beam clipper V_2 . Both plate and screen voltages on this tube must be kept low for good clipping.

A square-wave signal appears across plate load R_{20} and is applied through C_{14} to the wide-band volt-

age amplifier V_3 . The amplified square-wave signal is then applied through C_{15} to the cathode-follower output stage V_4 which permits a low-impedance output.

Direct voltages to operate the instrument are supplied by a conventional full-wave rectifier power supply using a 5Y3GT.

Design Features

Small-value plate-load resistors are used in each amplifier stage to provide wide frequency response and to minimize the effect of distributed capacitance.

To amplify a square-wave signal with minimum waveform distortion, an amplifier should be capable of amplifying frequencies without attenuation to at least the tenth harmonic of the square-wave fundamental frequency. Since the highest frequency square-wave signal supplied by this unit is 500,000 pps, the amplifiers must be reasonably flat to better than 5 megacycles. By using small plate-load resistors and care in wiring it has been possible to accomplish this without having to use peaking coils or other means to boost the high-frequency response. This is desirable so that the final square wave will be free of overshoots, ringing and high-frequency phase shift.

At low frequencies, other prob-

lems are encountered. Since a low-frequency square wave may be considered as a switched d-c signal, the amplifier circuits must be capable of holding a steady level during a period equal to one-half a cycle of the lowest-frequency square wave to be obtained. Towards this end, large R-C time constants are used in coupling between stages and large-capacitance electrolytics are used in filtering and by-pass circuits.

Several requirements dictated the design of the output circuit. In common with all wide-band devices, the output impedance had to be low. At the same time, it was desired to provide control over the output level at minimum cost and without distortion of signal waveform at different levels.

A cathode-follower output circuit was selected and a low-resistance potentiometer, R_{27} , used to control the output level. Even with these precautions, the waveform suffered near the ends of rotation of the control. This was due to the frequency consciousness of a potentiometer type of control. To minimize this effect, fixed resistances, R_{28} and R_{29} , were added to prevent adjusting the control to extreme limits.

In the final circuit, it is possible to adjust the output level over the desired range without waveform distortion from 50 to 500,000 pulses per second.

Choice of Frequencies

Since a square-wave signal is satisfactory for checking an amplifier to at least the tenth harmonic of its fundamental repetition rate,

USING GATED-BEAM TUBE

Output from 50 to 500,000 pulses per second is provided in five steps for checking frequency response, phase shift or transient response. Simple circuit includes a symmetrical multivibrator, gated-beam tube, wide-band amplifier and cathode-follower output

it is not necessary to provide continuous frequency coverage in a square-wave generator. Four or five frequencies, if carefully chosen, are satisfactory for all normal work.

Frequencies permitting the final instrument to be applied with equal versatility to the design of audio amplifiers and pulse and video amplifiers were selected. For these reasons, repetition rates of 50, 1,000, 10,000, 100,000 and 500,000 pps were chosen.

Another model will be made available for wide-band, high-fidelity audio-amplifier work. It will supply signals at 50, 500, 5,000, 10,000 and 20,000 pps.

Output-signal level may be adjusted by means of R_{27} from approximately 0.8 to 8 volts peak-to-peak. This permits checking not only complete amplifier circuits but also individual stages and attenuator circuits. Output impedance varies from about 50 ohms to approximately 550 ohms, depending on the attenuator setting.

Rise time is good, and for the 500-kc signal is better than 0.07 microsecond.

Applications

The final instrument may be used for checking amplifiers, peaking or ringing networks, attenuator circuits, phase-shift circuits and pulsing circuits or devices.

For pulse formation, a conventional differentiating circuit may be used in conjunction with the square-wave generator.

When the instrument is used, normal precautions should be followed. Unless necessary to minimize hum pickup, a shielded output

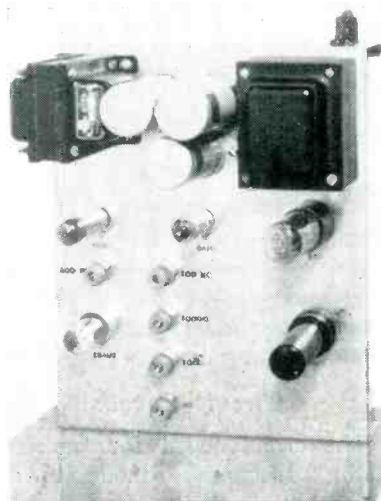

Chassis of square-wave generator, showing dual-potentiometer adjusting screws for the five output frequencies

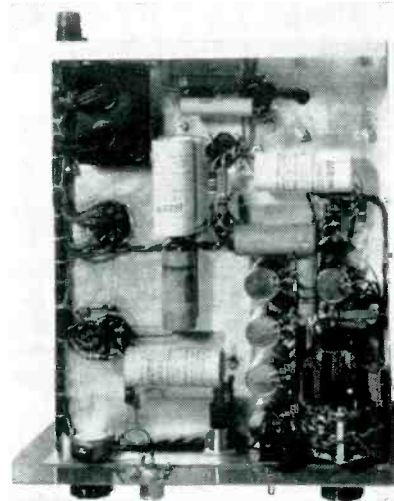

Underside of chassis with output potentiometer, output jack, power switch and frequency-selector switch visible

cable should not be used. An open line is preferred to prevent high-frequency signal loss and resultant rounding of the square-wave signal.

Since a direct voltage is present along with the square-wave signal at the output terminal, a blocking capacitor should be connected in series with the hot lead if d-c cannot be tolerated in the circuit to which the generator is connected. The size of this capacitor will be determined by the input impedance of the circuit to be tested and, for this reason, a capacitor was not incorporated as part of the instrument. The capacitor used should be selected to provide an R-C time constant, with the input impedance of the circuit to be tested, at least 25 times greater than the time of one cycle of the lowest-frequency square-wave to be used.

In all cases, connections to and

from the circuit tested should be kept as short as practicable. Long leads may introduce sufficient inductance in some amplifier circuits so that resonance at comparatively low frequencies occurs. This results in overshoots and transient oscillation when signals having a short rise time are used. Such distortion of the square-wave signal may lead to incorrect conclusions concerning the circuit tested.

The author wishes to thank Joseph Kaufman, Director of Education, National Radio Institute, for his encouragement and suggestions during the design of this instrument and Mort Massie for his help in securing special samples necessary for the construction of an experimental model.

REFERENCE

(1) Robert Adler, A Gated Beam Tube, *ELECTRONICS*, p 82, Feb. 1950.

TRANSISTOR FREQUENCY

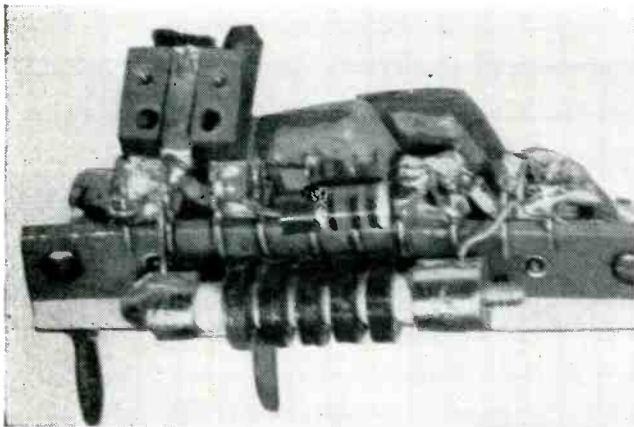

Actual-size photograph of transistor frequency modulator shows simplicity and compactness as compared to vacuum-tube modulator

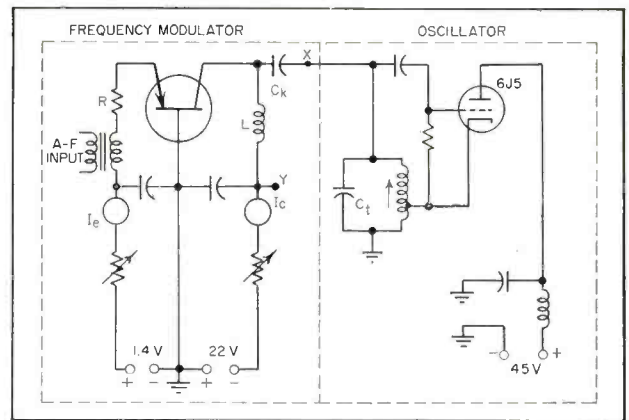

FIG. 1—Transistor frequency modulator provides low-distortion modulation with low d-c and a-f power input requirements. Signal frequencies up to 1.5 mc may be used

TRANSISTORS, since their introduction several years ago, have successfully been applied in many circuits originally designed to operate with vacuum tubes. Experimental work described here shows suitability of transistors for use as frequency modulators.

The control element of the transistor in this application is the emitter as in conventional amplifier circuits. The controlled element is, however, the internal impedance of the collector-base path. Measurements on transistors show that the internal collector impedance changes between broad limits if the voltage and the current are changed slightly between the emitter and base. The measurements further show that instead of the internal collector impedance being purely resistive, it is actually complex for some values of emitter current.

In some transistors the reactive component of the collector impedance changes its value from inductive to capacitive as the emitter current is changed. In other transistors the sign of the internal collector impedance remains the same within the range of emitter currents used.

The wide variation of internal collector impedance is used to produce frequency modulation in an oscillator circuit. A conventional tube circuit is used for the oscillator. The production of frequency modulation by resistance changes

has been proposed before^{1,2}. These methods use the variable internal plate resistance of tubes and some resistance-transforming means for coupling variable reactive elements to an oscillator tank.

Circuit Details

The circuit used for the transistor frequency modulator is somewhat simpler. Figure 1 shows the diagram of the experimental setup. The collector circuit of the transistor is fed with direct current through r-f choke L . A capacitor, C_k , not greater than about 1/10 of the oscillator tank capacitor, couples the collector to the oscillator tank. The emitter circuit is biased to class A amplifier service. The audio input is applied to the emitter circuit through series resistance R . This resistance reduces distortion caused by the nonlinear characteristic of the emitter circuit. The transistor cannot develop an audio-output voltage in the collector-load circuit, even if the collector current is varied, because r-f choke L acts as a short-circuit for the audio output. The audio signal applied to the emitter, however, varies the collector resistance between broad limits at an audio-frequency rate. Coupling capacitor C_k is coupled to the tank through the variable internal collector resistance of the transistor and the ground return. The r-f choke in parallel with the collector represents a high r-f re-

actance and can be neglected.

The coupling capacitor draws more or less capacitive current from the tank according to the instantaneous value of the transistor internal collector resistance. This produces a frequency modulation. The oscillator tank, however, is loaded through C_k with a variable resistance, which is the internal collector resistance. This variable loading effect produces some amplitude modulation. By proper selection of the oscillator tank capacitor, C_t , which should be of low reactance, the amplitude-modulation effect of the variable collector resistance can be kept below any desired value. A high value of reactance for the tank capacitor is needed, however, to produce a large frequency deviation for a given collector resistance variation. A sound compromise is possible between these contradictory requirements.

Figure 2 shows a typical static linearity curve for a transistor frequency modulator operating at 1.03-mc carrier frequency. During the static deviation measurements the flow of modulation current was simulated by varying the emitter bias-current resistor. Also shown in Fig. 2 is the amplitude variation of the frequency-modulated oscillator tank.

Figure 3A shows the equipment used to test the deviation and static linearity of the circuit. The signal from the oscillator under test is

MODULATOR CIRCUIT

Use of transistor in frequency-modulation circuit saves a-c filament power, reduces size and weight, requires less a-f driving power and reduces d-c power requirements. Distortion in transistor frequency modulator can be kept as low as in tube modulators

By L. L. KOROS and R. F. SCHWARTZ

Engineering Products Department,
Advanced Development Section
RCA Victor Division
Radio Corporation of America
Camden, New Jersey

picked up on a communications receiver (with c-w oscillator on) and the receiver output frequency deviations are measured by comparison with a calibrated audio signal generator using Lissajous figures.

The circuit of Fig. 1 was tested for its dynamic performance with a 400-cycle modulating signal. This was done by applying the audio signal to the a-f input terminals and observing the output by means of a discriminator and wave analyzer. Two 6SH7 limiter stages preceding the 6H6 discriminator seemed to give sufficient limiting for all signal levels encountered in this work and assured a linear output response of ± 2.5 volts d-c for $\pm 5,000$ -cps frequency variation with a 0.05-volt rms frequency-modulated input.

A distortion analysis of the modulator was made for three different values of deviation. Figure 3B shows graphically the relationship between the input voltage and the deviation for one of the transistors investigated. The results of the distortion analysis are shown in Table I. The distortion components were read on the wave analyzer at the discriminator output.

A measurement on the audio oscillator indicates that for the maximum deviation setting shown in Table I, and for a resistive load of the same order of magnitude as that represented by the modulator circuit, the output distortion of the audio oscillator was 0.3 percent rms. For output settings corresponding to the lower inputs used, the distortion is so low as to be considered negligible. No correction was used, therefore, on the data of Table I. Figure 3C shows the plot

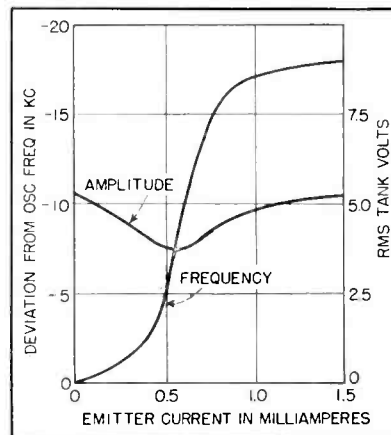

FIG. 2—Curves show linearity of modulation characteristics and effect of modulation on oscillator output amplitude

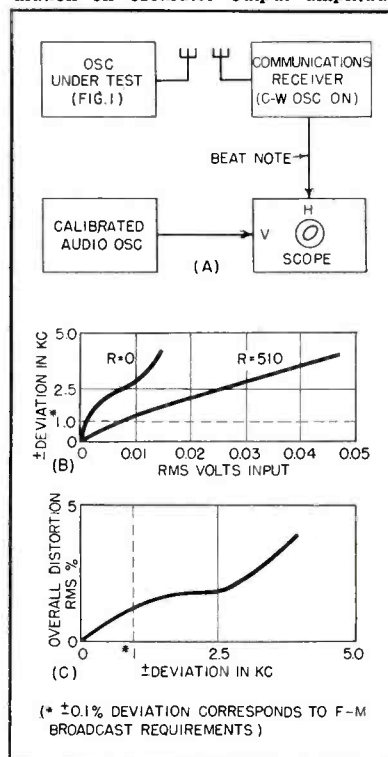

FIG. 3—Equipment used to test transistor frequency modulator is shown in A. Resulting curves for a typical transistor are given in B and C

of overall distortion versus deviation for the transistor considered here. The audio-frequency response of the transistor modulator was measured and is substantially constant from 20 to 15,000 cps for all of the transistors investigated.

The data given in Table I and Fig. 3C show that for a ± 0.1 -percent deviation of the carrier frequency, which is the upper limit required in the f-m services, the distortion was reasonably low. The interpolated value was only 1 percent rms. Figure 3B shows that the input voltage to the modulator to obtain this deviation was also low. The ± 0.1 -percent frequency deviation was achieved with about 0.008 volt rms input. The input resistance of the emitter circuit with a 510-ohm series resistor R was about 650 ohms. For maximum deviation the input requirement of the modulator with the linearizing resistor was therefore about -40 db (0 level 1 milliwatt). The input without linearizing resistor was -55 db. The input requirement showed fluctuations in the order of 6 db from transistor to transistor.

Internal Collector Resistance

Two equivalent circuits of the modulator are shown in the insert in Fig. 4. Any collector reactance is included in C_c . This form of representation does not follow the real situation because the coupling capacitor has a predetermined value and the changing element is the collector impedance. It is more convenient, however, to separate the resistive and reactive elements into two groups and to consider the modulator as a series or parallel

combination of a capacitor and resistor. The equivalence of the series and parallel representation is expressed by

$$R_s - jX_s = -\frac{R_p jX_p}{R_p - jX_p} \quad (1)$$

$$\frac{X_s}{R_s} = \frac{R_p}{X_p} \quad (2)$$

where X_s and X_p are the reactances

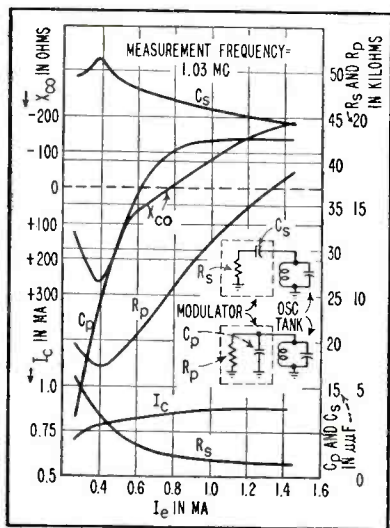

FIG. 4—Curves show relationship between emitter current and other circuit variables for two forms of equivalent circuit

of C_s and C_p respectively at the oscillator frequency.

For practical purposes, the data which can be measured directly by the easiest method are C_p and ΔC_p , the change of C_p . Resistance R_p can be measured by a Q-meter, and C_s and R_s can be computed.

From Eq. 1 and 2

$$C_s = C_p \frac{X_p^2 + R_p^2}{R_p^2} \quad (3)$$

$$R_s = R_p \frac{X_p^2}{X_p^2 + R_p^2} \quad (4)$$

The frequency deviation Δf is expressed by

$$\Delta f = -\frac{f}{2C_s} \Delta C_p \quad (5)$$

If it is found that the calculated $C_s = C_k$, which is the coupling capacitor actually used, the internal collector impedance is purely resistive and its value is identical with R_s . If, however, it is found that C_s is less than C_k it means that the internal collector impedance can be represented by a resistor and capacitor in series. If C_s is greater

than C_k the internal collector impedance can be represented by a series combination of a resistance and inductance.

The technique used to measure C_p , ΔC_p and R_p consists of the determination of the Q of the network formed by the internal collector impedance and the coupling capacitor C_k connected in series. The frequency modulator part of Fig. 1 is coupled to the Q-meter at X and Y. The inductance of the Q-meter, for obtaining the most exact figures, should be chosen lower than recommended for normal use of the instrument at the same frequency, in order to make the Q reading on a convenient range on the meter. If lower inductance is used it is necessary to add capacitors in parallel to the variable capacitor of the Q-meter to tune the circuit to resonance at the investigated frequencies. The techniques of the measurement are as follows: (1) Tune the Q-meter's variable capacitor to maximum Q-reading, before the transistor is inserted in its socket. Read Q_o and C_o . (2) Plug in the transistor and select different emitter current values I_e . (3) Tune the Q-meter's variable capacitor to maximum Q-reading again with each I_e setting and read the $Q(I_e)$ and the changes on the Q-meter capacitor ΔC_p . From the Q readings for the different emitter currents, R_p is computed as

$$R_p = \frac{Q_o Q(I_e)}{Q_o - Q(I_e)} X_L \quad (6)$$

where X_L is the reactance of the Q-meter coil used. To minimize errors due to distributed capacitances and lead inductances, the transistor socket with the coupling capacitor C_k and the r-f feed choke L was built as a compact unit which was directly plugged into the terminals of the Q-meter. A photograph of this frequency modulator unit is shown.

The curves of Fig. 4 show the values of C_p , R_p , C_s and R_s as functions of the emitter current at 1.03 mc for one transistor. The experimental data are presented in Table II. The values of the collector current I_c are also shown in the same figure. The values of C_p and Q were measured, and the values of R_p , C_s and R_s were calculated from

Eq. 6, 3 and 4. The reactive component of the internal collector impedance is represented by X_{co} . The computation of X_{co} was done with the expression $X_{co} = X_{ck} - X_s$, where X_{ck} is the reactance of the coupling capacitor and X_s is the reactance of C_s at the r-f carrier frequency. As Fig. 4 shows, the value of the reactive component X_{co} was found to be low compared with R_s . Nevertheless, it had an influence on the frequency deviation. Reactance X_{co} changed in this case from inductive to capacitive values. There were found, however, transistors where X_{co} was even smaller and the internal collector impedance was, for the main part, resistive. It was also found that the collector resistance and reactance depended upon the electrical history of the transistor. In the investigated cases, however, if the transistor showed amplification properties, the frequency-modulation property also was present.

Figure 4 shows that a large variation of the resistive component of the collector impedance, about 600 to 5,000 ohms, takes place for only a small change of the order of one milliamper in emitter current. Since the emitter resistance is of the order of 100 ohms, only a small input power is required for a relatively large change in collector resistance, as we have previously seen. Such a variation is an interesting feature which makes the transistor especially useful as a frequency modulator.

The transistor frequency modulator may introduce some jittering of the oscillator frequency due to instability of the transistor constants and to temperature changes. If the center frequency of the oscillator is stabilized by means of a discriminator and standard frequency

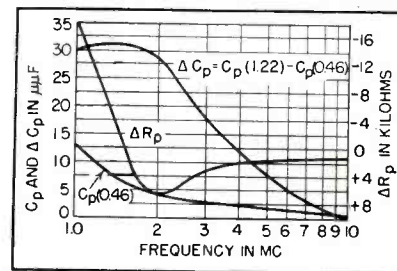

FIG. 5—By careful choice of transistors, operating frequency of frequency modulator can be extended up to 10 mc

CONSULT CINCH

...FOR THE DESIGN AND PRODUCTION OF MILITARY VERSIONS OF ANY COMMERCIAL ELECTRONICS COMPONENT.

Cinch is producing many variations of standard electronic components for military use.

CONSULT CINCH FOR THE PRODUCTION OF ANY COMPONENT ASSEMBLY NEEDED FOR WAR THAT FALLS WITHIN THE GENERAL CATEGORY OF ELECTRONIC PARTS MANUFACTURE.

The Cinch organization is flexible, readily adapted to any requirement . . . in military or commercial emergency, ample physical properties in space and production facilities, development, design, and production engineering personnel. Consult Cinch today.

CINCH components are available at leading electronic jobbers—everywhere.



Cinch
ELECTRONIC
COMPONENTS

CINCH MANUFACTURING CORPORATION

1026 South Homan Ave., Chicago 24, Illinois

Subsidiary of United-Carr Fastener Corporation, Cambridge, Mass.

source, as is the standard practice for broadcast transmitters, a considerable part of the effect of transistor instability is eliminated.

Modulating Higher Frequencies

The relatively low output power of the frequency-modulated oscillator cannot be considered as a limitation of the system, because the frequency multiplier stages amplify and multiply the r-f excitation to the necessary power level to excite the f-m power amplifier tube.

To obtain information about the capability of the transistors to modulate oscillators at higher frequencies, several transistors were tried with the previously described Q-meter method at frequencies between 1 and 10 mc. Figure 5 represents typical experimental data. Table III shows the measured values.

The emitter current limits of 0.46 ma to 1.22 ma (with the corresponding collector current units of 0.74 ma to 0.86 ma) were selected to produce high C_p changes around the linear response part of the frequency-modulation characteristic. The R_p values were computed again by Eq. 4. The changes of R_p (ΔR_p) are represented also in Fig. 5. The sign of ΔR_p indicates whether the parallel resistance value is going down with increasing emitter current, in which case ΔR_p is shown as positive, or going up, in which ΔR_p is shown as negative. This increasing or decreasing character depends, in the case of one investigated transistor, upon the applied frequency. In the case of another transistor, R_p decreased with increasing emitter current for all frequencies between 1 and 10 mc.

Figure 5 shows that this transistor unit with the coupling capacitor of 47 $\mu\mu\text{f}$ has a reasonably high ΔC_p value, and consequently has frequency modulation capability up to 2.5 mc. The behavior of the transistors is not uniform at higher frequencies. It is too early to say what is the upper frequency limit of the transistor in f-m service. Of course the flexibility of the modulator will be higher if the oscillator frequency can be increased. Otherwise, at least one more frequency multiplier stage must be used. This additional

Table I—Overall Measured Distortion

Input Voltage to Modulator (rms volts)	Deviation (\pm cps)	Distortion Components of 400-cps modulating tone		Overall Distortion (rms %)
		Harmonic	% Fund.	
0.0132	1,350	2nd	0.979	1.32
		3rd	0.769	
		4th	0.419	
		5th	
0.0330	2,850	2nd	1.91	2.12
		3rd	0.800	
		4th	0.450	
		5th	
0.0160	3,900	2nd	3.62	3.72
		3rd	0.75	
		4th	0.30	
		5th	0.337	

Table II—Measurement of Collector Variables

I_e (ma)	I_c (ma)	Q	C_Q^*	C_p ($\mu\mu\text{f}$)	R_p (Kilohms)	C_s ($\mu\mu\text{f}$)	R_s (Kilohms)	X_{co} (Kilohms)
		106**	177	0	Before inserting transistor			
0.46	0.74	55	165	12	7.37	48.4	5.55	+0.09
0.58	0.78	50	155	22	6.12	51.1	3.48	+0.26
0.75	0.81	54	142.5	34.5	7.12	48.2	2.02	+0.08
0.96	0.84	62.5	136	41	9.84	47	1.26	0
1.22	0.86	70	134.5	42.5	13.35	45.7	0.92	-0.09
1.64	0.86	75.5	134.5	42.5	16.98	44.4	0.74	-0.19

* C_Q is the reading of variable capacitor in Q-meter. A fixed capacitor was used parallel to C_Q to tune the 10-microhenry coil to 1.03 mc.
 ** The first line represents Q_0 , the others $Q(I_e)$.

Table III—Measurement of Frequency Response

f (mc)	Coil (μh)	Q (0.46)	Q (1.22)	C_Q (0.46)* ($\mu\mu\text{f}$)	C_Q (1.22)* ($\mu\mu\text{f}$)	C_p^{**} ($\mu\mu\text{f}$)	ΔC_p ($\mu\mu\text{f}$)
1.03	10	55	70	165	134.5	12	30.5
2	5	60	39	204	175	4	29
3	1	56	42	261	243	3	18
4	1	71	40	268	255		13
5	1	72	32	126	120	2	6
7.5	1	71	21	418	414	2	4
10	1	59	20	225	225	1	0

* C_Q (0.46) and C_Q (1.22) represent readings of variable capacitor in Q-meter at 0.46 and 1.22-ma emitter currents.
 ** C_p is capacitor value represented by transistor at 0.46-ma emitter current.

stage might also be necessary for high-power transmitters due to the low oscillator power. As transistor development advances and the similarity between units becomes greater, the reasonable upper frequency limit and oscillator tank voltage limit for the transistor

frequency modulator can be determined.

REFERENCES

- (1) A. V. Eastman and E. D. Scott, Transmission Lines as Frequency Modulators, *Proc. IRE*, p 878, July 1934.
- (2) B. E. Montgomery, Inductively Coupled Frequency Modulator, *Proc. IRE*, p 559, Oct. 1941.

**Value
Beyond
Expectation!**

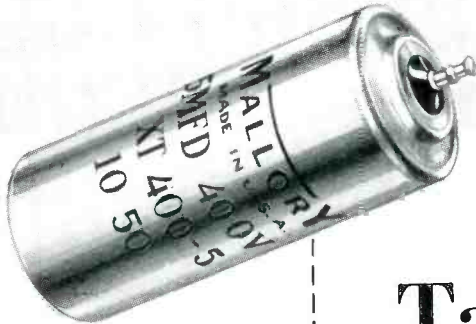

Solidifying temperature
of many oils.

Greater than the melting
point of some solders.

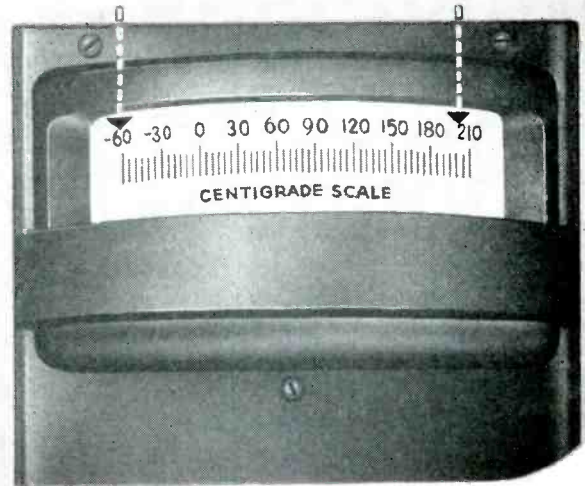

Mallory Tantalum Capacitor

*Gives Plus Performance
Over Extreme Temperature Range*

A new Technical Information Bulletin has been prepared to give you detailed specifications on the Mallory XT Tantalum Capacitor. Included are details on Sizes, Mounting Arrangements and Surge Voltages... as well as a complete set of performance curves on capacitance, impedance and resistance under a wide range of temperature conditions.

After more than eight years of research and development, Mallory engineering has succeeded in perfecting a capacitor that operates continuously from -60° to $+200^{\circ}$ C.

The new Mallory XT Tantalum Capacitor is ideal for use in a wide range of applications... particularly those included in the trend toward smaller, more compact electronic assemblies. Miniaturization makes unprecedented demands upon individual components and usually reflects a marked increase in the total heat generated. The Mallory Tantalum Capacitor, available in a variety of ratings of the single section type, serves well under extremes of both high and low temperature conditions... a plus performance that affords greater dependability in critical services.

That's value beyond expectation!

Mallory capacitor know-how is at your disposal. What Mallory has done for others can be done for you.

P. R. MALLORY & CO., Inc.
MALLORY

P. R. MALLORY & CO., Inc., INDIANAPOLIS 6, INDIANA

SERVING INDUSTRY WITH

Electromechanical Products
Resistors *Switches*
TV Tuners *Vibrators*

Electrochemical Products
Capacitors *Rectifiers*
Mercury Dry Batteries

Metallurgical Products
Contacts *Special Metals*
Welding Materials

TUBES AT WORK

Including INDUSTRIAL CONTROL

Edited by RONALD K. JURGEN

Acoustic Mill-Feed Controller.....	136
Subminiature Low-Frequency Receiver.....	138
Reducing Transmitter Out Time.....	158
Pulse-Sharpening Circuit.....	162
Constant-Amplitude Oscillator.....	164
Home-Heating Control Modification.....	170
Thermal Shunt for Soldering Resistors.....	176
Position Indicator.....	178
Measuring Muzzle Velocity.....	180
Robot Control for TV Transmitter.....	182

Acoustic Mill-Feed Controller

PULVERIZED FUEL for modern draught-fed furnaces and boilers is processed in what are known as tube mills. Coal fed continuously into this type of mill is reduced to the consistency of fine grade powder by the action of cascading steel balls within a rotating tube or drum. Efficiency is almost entirely dependent on the correct amount of raw coal being continuously maintained within the tube.

In fuel processing mills, the rate of feed required is dictated by a number of variable factors. Therefore, to be effective, any method of automatic feed control must be based on the actual, and not estimated, amount of raw coal within the tube or drum.

Controller Apparatus

Since it is not possible to make an assessment of the quantity within the tube based on the amount of coal fed into the mill or its output, the acoustic mill-feed controller has been designed to determine the actual contents of the mill from the noise level of the cascading coal and balls in contact with each other and the walls of the drum. As with the human ear, this determination calls for fine distinctions in noise level taken at a reference point in the immediate vicinity of the drum.

The basic apparatus consists of a

microphone, adequately protected against dust and dirt, placed immediately beneath the drum. The microphone is connected by cable to the main controller unit which is set up at any desired distance

from the tube mill.

The output stage of the controller unit comprises a series of pads for lining-up purposes, an amplifier and a high-pass filter. The function of the filter is to segregate the significant high-frequency noises emanating chiefly from inside the drum from the low-frequency noises associated chiefly with the external gearing and drive of the mill itself.

The most significant noise frequencies have been found to exist at about 4 kc. These frequencies give a noise discrimination of about 14 db between the full and empty condition of the tube as compared with about 3 db, which is the best discrimination possible when considering the over-all noise frequency spectrum of the mill.

The output from the amplifier-filter stage of the controller is used to actuate a sensitive relay adjusted to operate in accordance with fluctuations in noise above and below a set figure corresponding to the optimum amount of coal in the tube. The relay serves to provide, through suitable heating coils and

TV FAN BUILDS \$10,000 SHACK



Virgil H. Ruppenthal built this retreat in the mountains near Cumberland, Md., and supplied it with the latest in tv equipment including a 19-inch set, f-m receivers, fancy speaker cabinet and various test equipment, at a total cost of \$10,000. Ruppenthal gets reception from more than 15 tv stations and 60 f-m stations. Interior of the shack is pine-panelled with inlaid linoleum floor and has modern kitchen and bath with hot and cold running water

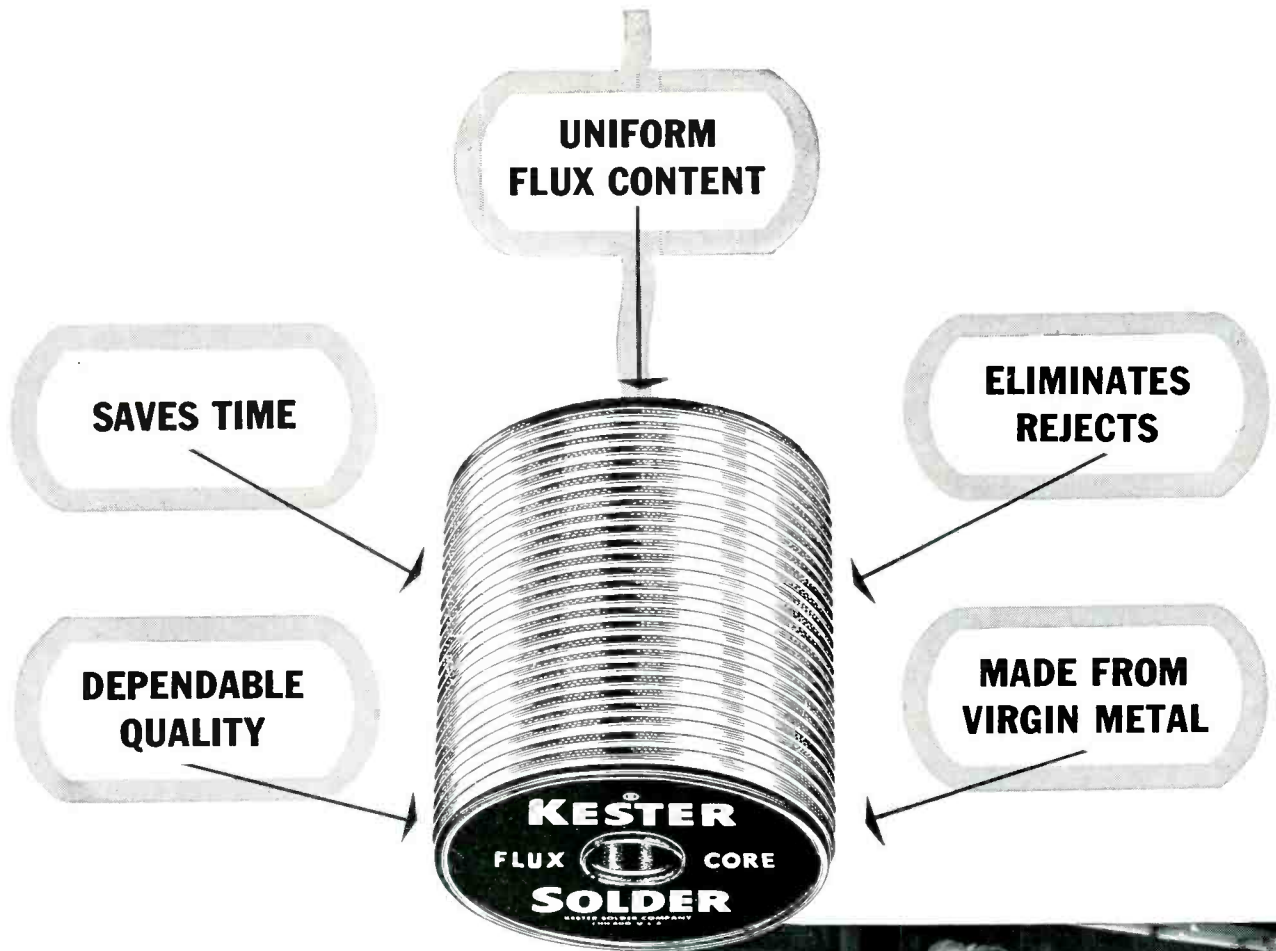

KESTER

the Solder

*that gets Speed
into
TV Production*

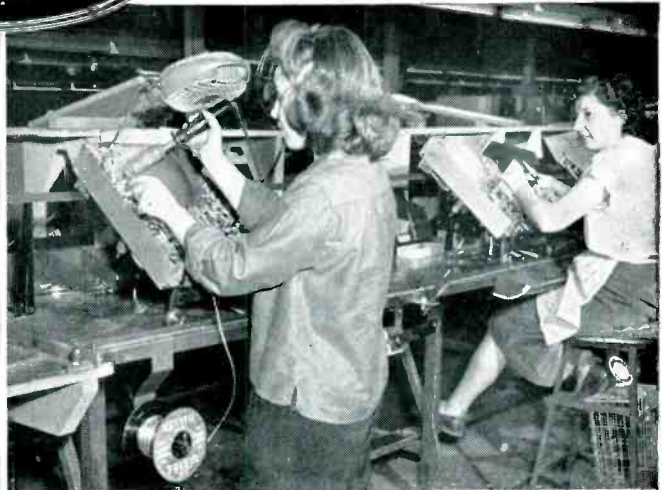

Using Kester Flux-Core Solders, Plastic-Rosin and "Resin-Five" Core Solders, will keep your solderers satisfied. Kester flows better—handles easier—faster to use. Kester Solders are made only from newly mined grade A tin and virgin lead.

FREE TECHNICAL MANUAL—Send for your copy of SOLDER and Soldering Technique.

KESTER SOLDER COMPANY • 4204 WRIGHTWOOD AVE.
CHICAGO 39, ILL. • NEWARK, N. J. • BRANTFORD, CANADA



THE FRONT COVER

THE COVER photograph this month shows a production tank unit for the Simmonds electronic fuel gage in the process of being tested to see if tank unit electrical capacitance compares favorably with quality control requirements. The inspection is being made on a Master Laboratory capacitance bridge.

The capacitance bridge network consists of a Campbell Shackelton shielded ratio box, a Hewlett-Packard a-f signal generator to supply alternating voltage and a detector which works through an amplifier and a 1,000-cycle selective filter or straight through for other frequencies. Leeds and Northrup single-range potentiometer indicators are also used.

The Pacitron Gage system consists of a tank unit of variable capacitance, an amplifier as shown in the accompanying schematic, a bridge calibrator and a

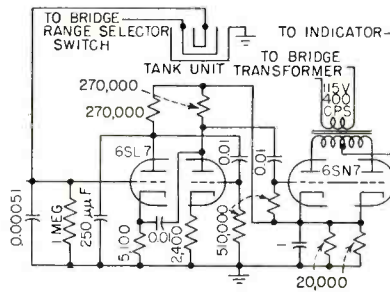

motor-driven indicator. In the system, the capacity of the tank unit is constantly compared with a fixed-capacitance reference capacitor.

The voltage resulting from a difference in capacitance is amplified and applied to a motor-driven potentiometer which restores the bridge to balance. The quantity of fuel, as sensed by the tank unit, determines the potentiometer wiper position. An indicator pointer attached to the potentiometer indicates the quantity of fuel.

oscillator, two 135-kc i-f amplifier stages with a bandwidth of about 2 kc, a diode detector, an avc diode, a beat-frequency oscillator, an audio amplifier stage and a push-pull-parallel power output stage. All stages operate with 26 volts d-c on heaters, screens, and plates. Under these conditions of operation, four subminiature audio power output tubes are required for adequate power output.

To facilitate mass production, seven detachable subassemblies, each of which can be built independently, are employed in the receiver. This also permits easier servicing. The subassemblies are fastened to one another and to the front panel, which takes the place of a chassis.

Printed circuits are used to a considerable extent. They are of value both in conserving space and for economical mass production. The wiring is printed on steatite or silicone-impregnated fiber-glass.

Hermetic Sealing

Hermetic sealing of the entire unit affords protection against moisture and contamination. It also permits elimination of protective coatings for the individual components, which saves space. A soldered copper band seals the housing to the front panel. The band can be removed for repair purposes with a key of the type used for opening coffee cans. The air in the unit is replaced with nitrogen before sealing to prevent oxidation.

The tuning of the receiver over its wide operating frequency range was a difficult engineering problem. A straight-line tuning characteristic (frequency proportional to control angle) was attained in the limited space allowable by the use of a variable-pitch screw to drive the slugs in and out of the r-f coils.

The tuning slugs are made of the newly developed ferrite base materials, more stable at high temperatures than powdered-iron cores. It was expected that production control of these new materials might present a difficulty; mechanical means were therefore provided in the tuner to compensate for non-uniformity of core material.

The i-f transformers have an over-all size of $\frac{1}{2}$ by $\frac{1}{2}$ by $1\frac{3}{8}$ inches;

(continued on page 156)

relay trains, a means of altering the speed of the feed motor or, alternatively, for manual control purposes, of actuating a suitable gage to afford visual indication of

the contents of the tube mill.

The equipment is manufactured by Standard Telephones and Cables Limited in Aldwych, London, England.

Subminiature Low-Frequency Receiver

A SUBMINIATURE radio receiver for aircraft use, continuously tunable from 190 to 550 kc and utilizing a 135-kc i-f amplifier, has

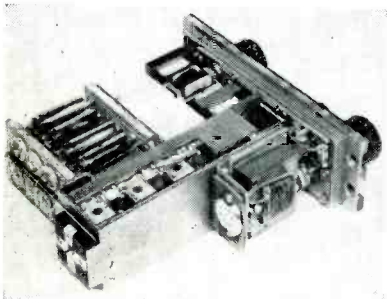

New subminiature receiver chassis ready for encasement and hermetic sealing in nitrogen

been developed by the National Bureau of Standards. This assembly occupies about 55 cubic inches and is the functional equivalent of a World War II unit more than five times as large.

The new 12-tube receiver, in conjunction with a previous high-frequency project (a 60-mc, 11-tube i-f amplifier assembly), effectively brackets the communication spectrum. The receiver is used to keep aircraft on course. It has a sensitivity of $5 \mu\text{v}$ for 6 db signal-to-noise ratio and a power output of 100 milliwatts.

The 12 tubes provide two tuned r-f amplifier stages, a mixer, a local

Hermetically-sealed CUP CERAMIC CAPACITORS for Precision tuned Circuits

With
**SPRAGUE
HERLEC**
Dependability

Top-notch capacitance stability, high Q, and excellent retrace characteristics are only part of the story on Sprague-Herlec Cup Ceramic Capacitors.

In addition, they are small, hermetically-sealed, and easy to mount securely against the effects of vibration and shock. Their extreme stability and compactness make them unexcelled for rigid frequency control applications and as reference capacitance standards in either laboratories or electronic circuits. Low self-inductance likewise makes them valuable in v-h-f bypass applications.

With Sprague-Herlec metal cup ceramic capacitors in precision circuits, it is often possible to control the capacitance tolerance within $\pm 1\%$ and the temperature coefficient tolerance within ± 10 parts per million!

For complete details write for Engineering Bulletin 603 to either Sprague or Herlec

HERLEC CORPORATION

422 N. 5th Street, Milwaukee, Wisconsin; A wholly-owned subsidiary of the

SPRAGUE ELECTRIC COMPANY

North Adams, Massachusetts

THE ELECTRON ART

Edited by JAMES D. FAHNESTOCK

Checking Quality of Aluminized Screens.....	140
Current Transformers for Audio Measurements.....	188
Improved Terratex	196
Distributed Resistance Ignition Cable.....	204
Logarithmic Counting Rate Meter.....	208

Checking Quality of Aluminized Screens

BY HOWARD J. EVANS
*Tube Department
Radio Corporation of America
Harrison, New Jersey*

TO AVOID waste manufacturing steps, two methods have been developed to test aluminized picture screens before the gun structures are sealed into the bulbs. These developments were necessary because the standard test on non-aluminized screens cannot be used on aluminized ones.

Test Procedure

In the test on nonaluminized screens, after the phosphor has been deposited on the faceplate, the bulb is partially evacuated, and a high-frequency spark coil is moved over the faceplate. The resultant intense electric fields inside the bulb cause high-velocity electrons to strike the phosphor, exciting it so that actual operation of the finished tube is simulated and the quality of screen luminescence can be visually examined.

However, in bulbs which use an aluminized coating on the back of the phosphor to prevent ion-spot formation, the aluminum acts as a radio-frequency shield which prevents any outside electric fields from penetrating into the bulb enclosure. Formerly, therefore, the screens of aluminized picture tubes could not be fully tested until the tube was completed and examined in actual operation. Each defective screen, consequently, resulted in virtually a total loss, for the cost of

salvaging the good parts of the tube almost equalled the original cost.

Two Methods Devised

The two methods devised to prevent this waste permit a check of the quality of aluminized screens earlier in the manufacturing process. One, the radio-frequency method, uses a high-frequency oscillator to produce an electric field which impels high-speed electrons against the phosphor. The second, the direct-current method, accelerates the excitatory electrons by

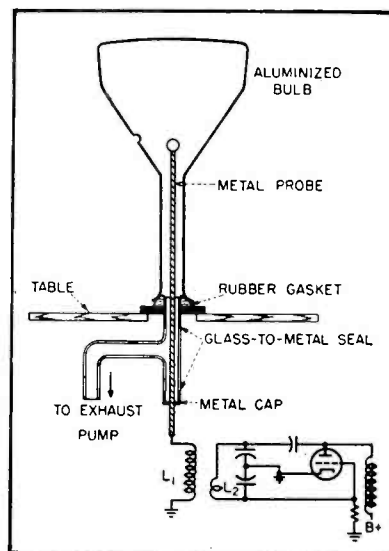

FIG. 1—Apparatus for examining screens of aluminized picture tubes by r-f method

means of direct voltage. This d-c method, although not now used in practice, will be described because it conceivably might be preferable if the presence of a strong radio-frequency field were undesirable.

Radio-Frequency Method

A representation of the r-f method is shown in Fig. 1. The bulb to be examined is connected in an upright position to the intake port of a vacuum system and the bulb is evacuated. The flanged portion of the bulb neck presses against the rubber gasket with sufficient force to form a gas-tight seal. When the final vacuum is established, this force is equal to the weight of the bulb plus the product of the atmospheric pressure and the area of the bulb flange. The rubber gasket is restrained from collapsing inward by the metal cylinder which is placed inside the gasket.

The electrical energy which causes screen excitation enters the evacuated bulb through the probe. When the probe is driven positive or negative, an electric field set up between the probe and the aluminized coating accelerates the free electrons or ions. The ions have a mean free path of the order of 1 centimeter when the pressure is 5 microns. This path is long compared with the radius of the neck, so that few ionization collisions occur in the neck region. However, the mean free path is short compared with the probe-to-screen distance, so that sufficient ionization collisions occur in the cone region to maintain the supply of ions and electrons. On the positive half of the r-f cycle the positive ions are repelled toward the screen. Since there is no electrical connection to the screen, these positive charges cause the screen to assume a positive potential with respect to ground. On the negative half of the cycle the probe becomes negative, and electrons and negative ions strike the aluminum coating with a maximum energy which, when measured in terms of electron volts, exceeds the maximum voltage between probe and ground. This energy is sufficient to cause the electrons to penetrate the alumi-

(continued on page 184)

Extends the **ADVANTAGES** of **Q** measurements to the **VHF** range

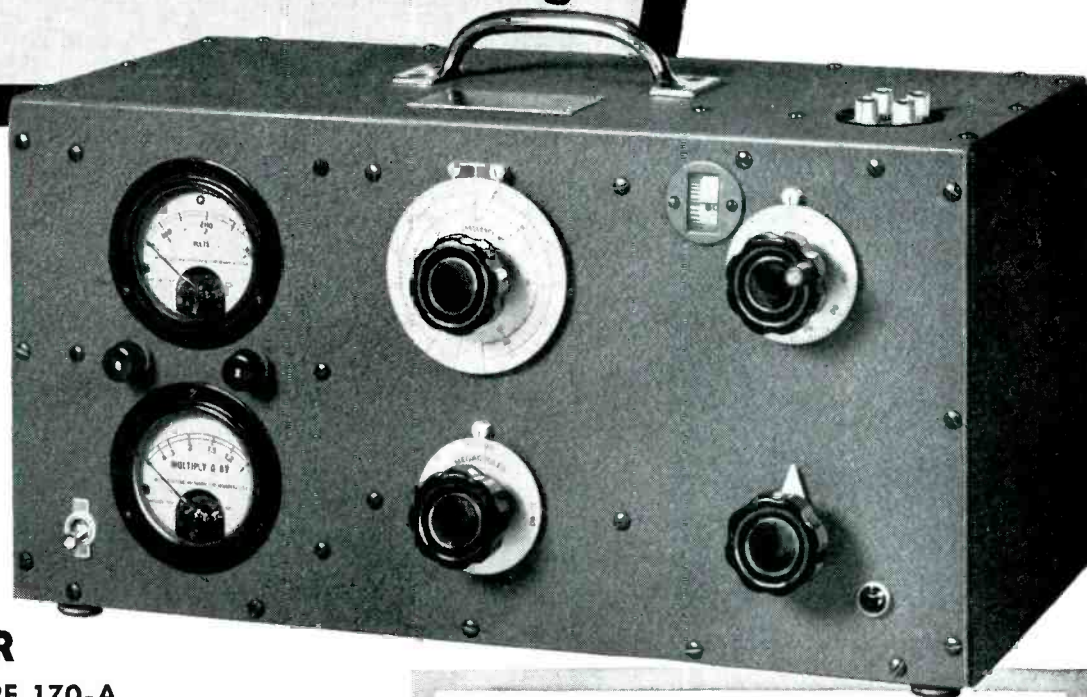

The **Q**
METER

TYPE 170-A
Freq. 30-200 mc.

Since the first use of tuned circuits, the ratio of their reactance to their losses at resonance has been an important factor of merit. This ratio, known as **Q**, specifies the band-width, cut-off rate and potential gain of the tuned circuit when used in an amplifier. The **Q Meter** is a standard of the industry because it quickly and accurately measures this fundamental, unchanging quantity.

Frequency ranges, tuned circuit designs and circuit applications have changed. To keep pace with these changing requirements, **Q Meters** have been introduced for different frequency ranges and with other design changes. The **Type 170-A Q Meter** is one of the results of our continuous program of developing precision equipment to meet the needs of laboratory and industry.

Write for complete information.

DESIGNERS AND MANUFACTURERS OF THE **Q METER** • **QX CHECKER**
FREQUENCY MODULATED SIGNAL GENERATOR • BEAT FREQUENCY
GENERATOR AND OTHER DIRECT READING INSTRUMENTS

MEASURES

- **Q of VHF Coils.**
- **Effective Inductance of Coils.**
- **Losses in Condensers and Dielectrics.**
- **Characteristics of VHF Antennas.**
- **Distributed Capacity of Coils.**

SPECIFICATIONS:

Oscillator Frequency Range: Continuously variable from 30 mc. to 200 mc. in 3 ranges.

Frequency Calibration Accuracy: $\pm 1\%$.

Range of **Q** Measurements: Directly Calibrated—80 to 300. By use of Multiplier—80 to 1200.

Accuracy of **Q** Measurements: Directly Calibrated Scale $\pm 10\%$ to 100 mc. Accuracy decreases with frequency above 100 mc.

Capacitance Calibration of **Q** Condenser:
Range 11 to 60 mmfd. with 1 mmfd. divisions.
Micrometer Vernier marked with 100 divisions.
Accuracy: 1% or 0.5 mmfd., whichever is greater.

Inductance Range: 0.05 microhenry to 1.3 microhenry.

Power Supply: 110-120 volts, 50-60 cycles.
Also 220-240 volts, 50-60 cycles.
Power Consumption—50 watts.

BOONTON RADIO

BOONTON · N.J. · U.S.A.



NEW PRODUCTS

Edited by WILLIAM P. O'BRIEN

Military Electronics Program Extends Miniaturization Trend . . .

Noncritical Materials Stand Out in Design for Civilian Use . . .

Available Manufacturers' Catalogs Are Listed



Tiny Electronic Amplifier

BENDIX RADIO DIVISION OF BENDIX AVIATION CORP., Baltimore 4, Md., has developed a tiny electronic amplifier for miniaturized airborne radar equipment. It is a band-pass type amplifier with a rated electrical gain of 130 db. Weighing less than 2 ounces and requiring only 35 component parts, its cost in large production quantities should be small enough to make feasible replacement of the entire amplifier in case of tube or component failure and because of its plug-in design replacement can be made in a matter of seconds. Illustrated is the unit as compared to a conventional band-pass amplifier as used in radar equipment.



Polyphase Reproducer

AUDAK Co., 500 Fifth Ave., New York 18, N. Y., has announced the Audax L-6-G, a new polyphase reproducer. This single magnetic

unit will play any and all lateral recordings at speeds of 33 $\frac{1}{3}$, 45 or 78 rpm. A special connector is available which permits the unit to be plugged into the Garrard changer arm. Point pressure is 8 grams for all discs. Output is approximately 20 mv. Response is from 20 to over 10,000 cps. The sapphire or diamond stylus is easily replaceable.



High-Temperature Variable Resistor

CHICAGO TELEPHONE SUPPLY CORP., Elkhart, Ill. Type 65 miniaturized variable composition resistor has extremely high temperature and humidity stability. It is specially designed for use in all types of military communications.



Mounting Bases

T. R. FINN & Co., INC., 333 Jackson Ave., Bronx 54, N. Y. Finnflex mounting bases, designed to protect airborne equipment such as aircraft radios, radar, loran and similar electronic apparatus, exceed Army-Navy E-19 drop test require-

ments. They are designed to meet dimensional and metal requirements of JAN C-172A specifications. Load range is from 6 to 80 lb. The unit illustrated is carried by four metallic spring-type isolators, which provide protection by maintaining their high vibration-isolating efficiency from -80 F to +250 F.

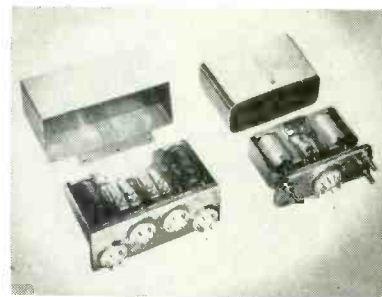

Sealed Multiple Relays

POTTER AND BRUMFIELD, Princeton, Indiana, has developed a line of 2-in-a-can and 4-in-a-can sealed relays for use in military airborne equipment. The 2-in-1 assembly has two-ampere palladium contacts on each relay. It has overall dimensions of 3 in. \times 1 $\frac{1}{2}$ in. \times 2 in. high and weighs 6 oz. The 4-in-1 assembly has 5-ampere silver contacts. It measures 3 $\frac{1}{2}$ in. \times 1 $\frac{1}{2}$ in. \times 2 in. high and weighs 13 oz. The relays are thoroughly desiccated and hermetically sealed in inert gas.

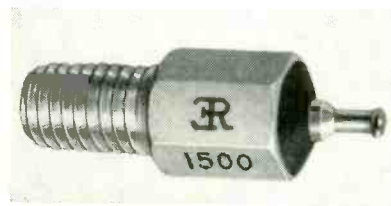

Sealed Stand-Off

ERIE RESISTOR CORP., 644 W. 12th St., Erie, Pa. Basic design of the style 326 stand-off Ceramicon for vhf and uhf applications provides, in a hermetically sealed case, a bypass-to-ground through the shortest possible path. Post terminal provides a sturdy tie point for several connections, and is made essentially to match tube socket terminal height in the interest of

Write For Your Free Copy Of This Complete RAYTHEON TUBE GUIDE



SUBMINIATURE TUBES

TYPE	CONSTRUCTIVE DATA	TYPICAL APPLICATION	HEAT FILAMENT	HEAT TYP	HEAT COND	MAX DIMENSIONS	PLATE VOLTAGE	GRID VOLTAGE	SCREEN VOLTAGE	PLATE CURR. MA	GRID CURR. MA	SCREEN CURR. MA	AMP. FACTOR	PLATE RESIST. OHM	INT. RESIST. OHM	INT. CAP. PF	LOAD RESIST. OHM	LOAD CAP. PF
6AV6	Hexode	R.F. Amplifier	1.25	100	TA	5A	15	300	200	45	2.0	0.8	0.0	0.0	2000			
6AV6C	Hexode	Detector	1.25	60	TA	5A	15	300	200	45	2.0	0.8	0.0	0.0	2000			
6AV6D	Hexode	Detector	1.25	60	TA	5A	15	300	200	45	2.0	0.8	0.0	0.0	2000			
6AV6E	Hexode	Detector	1.25	60	TA	5A	15	300	200	45	2.0	0.8	0.0	0.0	2000			

RELIABLE AND RUGGED TUBES

TYPE	CONSTRUCTIVE DATA	TYPICAL APPLICATION	HEAT FILAMENT	HEAT TYP	HEAT COND	MAX DIMENSIONS	PLATE VOLTAGE	GRID VOLTAGE	SCREEN VOLTAGE	PLATE CURR. MA	GRID CURR. MA	SCREEN CURR. MA	AMP. FACTOR	PLATE RESIST. OHM	INT. RESIST. OHM	INT. CAP. PF	LOAD RESIST. OHM	LOAD CAP. PF
6AR5	Diode	Rectifier	1.25	100	TA	5A	15	300	200	45	2.0	0.8	0.0	0.0	2000			
6AR5A	Diode	Rectifier	1.25	100	TA	5A	15	300	200	45	2.0	0.8	0.0	0.0	2000			
6AR5B	Diode	Rectifier	1.25	100	TA	5A	15	300	200	45	2.0	0.8	0.0	0.0	2000			
6AR5C	Diode	Rectifier	1.25	100	TA	5A	15	300	200	45	2.0	0.8	0.0	0.0	2000			

GERMANIUM CRYSTAL DIODES

DC characteristics measured at 25°C

TYPE	TYPICAL APPLICATION	HEAT FILAMENT	HEAT TYP	HEAT COND	MAX DIMENSIONS	PLATE VOLTAGE	GRID VOLTAGE	SCREEN VOLTAGE	PLATE CURR. MA	GRID CURR. MA	SCREEN CURR. MA	AMP. FACTOR	PLATE RESIST. OHM	INT. RESIST. OHM	INT. CAP. PF	LOAD RESIST. OHM	LOAD CAP. PF	
6X4	Diode	Rectifier	1.25	100	TA	5A	15	300	200	45	2.0	0.8	0.0	0.0	2000			
6X4A	Diode	Rectifier	1.25	100	TA	5A	15	300	200	45	2.0	0.8	0.0	0.0	2000			
6X4B	Diode	Rectifier	1.25	100	TA	5A	15	300	200	45	2.0	0.8	0.0	0.0	2000			
6X4C	Diode	Rectifier	1.25	100	TA	5A	15	300	200	45	2.0	0.8	0.0	0.0	2000			

ELECTROMETER TUBES

TYPE	CONSTRUCTIVE DATA	TYPICAL APPLICATION	HEAT FILAMENT	HEAT TYP	HEAT COND	MAX DIMENSIONS	PLATE VOLTAGE	GRID VOLTAGE	SCREEN VOLTAGE	PLATE CURR. MA	GRID CURR. MA	SCREEN CURR. MA	AMP. FACTOR	PLATE RESIST. OHM	INT. RESIST. OHM	INT. CAP. PF	LOAD RESIST. OHM	LOAD CAP. PF
6EM5	Diode	Electrometer	1.25	100	TA	5A	15	300	200	45	2.0	0.8	0.0	0.0	2000			
6EM5A	Diode	Electrometer	1.25	100	TA	5A	15	300	200	45	2.0	0.8	0.0	0.0	2000			
6EM5B	Diode	Electrometer	1.25	100	TA	5A	15	300	200	45	2.0	0.8	0.0	0.0	2000			
6EM5C	Diode	Electrometer	1.25	100	TA	5A	15	300	200	45	2.0	0.8	0.0	0.0	2000			

RADIATION COUNTER (GEIGER-MUELLER) TUBES

(All glass thin wall self-etching)

TYPE	MAX DIMENSIONS	OPERATING VOLTAGE RANGE	PLATE CURR. MA	SCREEN CURR. MA	RELATIVE SENSITIVITY	ANODE TEMP. °C	ANODE BIAS VOLTAGE	ANODE RESIST. OHM	ANODE CAP. PF	ANODE INDUCT. OHM	ANODE INDUCT. CAP. PF	ANODE INDUCT. RES. OHM	ANODE INDUCT. CAP. PF	ANODE INDUCT. RES. OHM	ANODE INDUCT. CAP. PF	ANODE INDUCT. RES. OHM	ANODE INDUCT. CAP. PF
6R13	1.25 x 1.00 x 1.00	150-250	0.5	0.5	1.0	25	100	100	100	100	100	100	100	100	100	100	100
6R13A	1.25 x 1.00 x 1.00	150-250	0.5	0.5	1.0	25	100	100	100	100	100	100	100	100	100	100	100
6R13B	1.25 x 1.00 x 1.00	150-250	0.5	0.5	1.0	25	100	100	100	100	100	100	100	100	100	100	100
6R13C	1.25 x 1.00 x 1.00	150-250	0.5	0.5	1.0	25	100	100	100	100	100	100	100	100	100	100	100

RECTIFIER TUBES

TYPE	CONSTRUCTIVE DATA	FILAMENT	HEAT FILAMENT	HEAT TYP	HEAT COND	MAX DIMENSIONS	PLATE VOLTAGE	GRID VOLTAGE	SCREEN VOLTAGE	PLATE CURR. MA	GRID CURR. MA	SCREEN CURR. MA	AMP. FACTOR	PLATE RESIST. OHM	INT. RESIST. OHM	INT. CAP. PF	LOAD RESIST. OHM	LOAD CAP. PF
6AR5	Diode	Rectifier	1.25	100	TA	5A	15	300	200	45	2.0	0.8	0.0	0.0	2000			
6AR5A	Diode	Rectifier	1.25	100	TA	5A	15	300	200	45	2.0	0.8	0.0	0.0	2000			
6AR5B	Diode	Rectifier	1.25	100	TA	5A	15	300	200	45	2.0	0.8	0.0	0.0	2000			
6AR5C	Diode	Rectifier	1.25	100	TA	5A	15	300	200	45	2.0	0.8	0.0	0.0	2000			

TELEVISION PICTURE TUBES

TYPE	BASE SIZE	TYPE	CONSTRUCTION	FILAMENT	HEAT FILAMENT	HEAT TYP	HEAT COND	MAX DIMENSIONS	PLATE VOLTAGE	GRID VOLTAGE	SCREEN VOLTAGE	PLATE CURR. MA	GRID CURR. MA	SCREEN CURR. MA	AMP. FACTOR	PLATE RESIST. OHM	INT. RESIST. OHM	INT. CAP. PF	LOAD RESIST. OHM	LOAD CAP. PF
7JP6	4 x 5 1/2	6.3	6.6	1 G-M12	7%	147	7%	None	Elec.	Elec.	None	None	None	None	None	None	None	None	None	None
8AP4	5 1/2 x 7	6.3	6.6	1 G-M12	7%	147	7%	None	Elec.	Elec.	None	None	None	None	None	None	None	None	None	None
10BP4	4 x 4	6.3	6.6	1 G-M12	7%	147	7%	None	Elec.	Elec.	None	None	None	None	None	None	None	None	None	None
10CP4	4 x 4	6.3	6.6	1 G-M12	7%	147	7%	None	Elec.	Elec.	None	None	None	None	None	None	None	None	None	None
10DP4	4 x 4	6.3	6.6	1 G-M12	7%	147	7%	None	Elec.	Elec.	None	None	None	None	None	None	None	None	None	None
10EP4	4 x 4	6.3	6.6	1 G-M12	7%	147	7%	None	Elec.	Elec.	None	None	None	None	None	None	None	None	None	None
10FP4	4 x 4	6.3	6.6	1 G-M12	7%	147	7%	None	Elec.	Elec.	None	None	None	None	None	None	None	None	None	None
10HP4	4 x 4	6.3	6.6	1 G-M12	7%	147	7%	None	Elec.	Elec.	None	None	None	None	None	None	None	None	None	None

RECEIVING TUBES

TYPE	BASE SIZE	TYPE	CONSTRUCTION	FILAMENT	HEAT FILAMENT	HEAT TYP	HEAT COND	MAX DIMENSIONS	PLATE VOLTAGE	GRID VOLTAGE	SCREEN VOLTAGE	PLATE CURR. MA	GRID CURR. MA	SCREEN CURR. MA	AMP. FACTOR	PLATE RESIST. OHM	INT. RESIST. OHM	INT. CAP. PF	LOAD RESIST. OHM	LOAD CAP. PF
6AR5	Diode	Rectifier	1.25	100	TA	5A	15	300	200	45	2.0	0.8	0.0	0.0	2000					
6AR5A	Diode	Rectifier	1.25	100	TA	5A	15	300	200	45	2.0	0.8	0.0	0.0	2000					
6AR5B	Diode	Rectifier	1.25	100	TA	5A	15	300	200	45	2.0	0.8	0.0	0.0	2000					
6AR5C	Diode	Rectifier	1.25	100	TA	5A	15	300	200	45	2.0	0.8	0.0	0.0	2000					

The booklet pictured provides performance data on the finest line of quality tubes in the world - Raytheon Tubes. Most of these tubes have been pioneered and developed by Raytheon - many are manufactured exclusively by Raytheon - all will outperform any other tubes in the field.

Get this free Tube Characteristics Booklet today. Write



RAYTHEON MANUFACTURING COMPANY
 Special Tube Section
 NEWTON 58 • MASSACHUSETTS

maintaining uniform short leads. Designed for threaded mounting installation, it is available in standard capacitance values in μmf : 10, 33, 47, 68, 82, 100, 680, 1,000 and 1,500. Voltage rating is 500 v d-c.

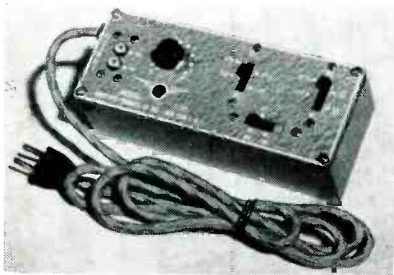

Miniature Signal Generator

RADIO CITY PRODUCTS CO., INC., 152 W. 25th St., New York 1, N. Y. Model 730 pocket-size, signal generator combines a real f-m signal generator, an r-f signal generator, and an audio oscillator. The four f-m fixed frequencies are modulated to give ample sweep for use with ratio detectors. Alignment can be quickly made at the ends of the band at the 88 and 108-mc switch position. Correspondingly, the 10.7 and 9.1-mc switch positions permit alignment of the i-f sections. The ends of the broadcast band can be readily aligned at the 1,500-kc and 550-kc switch positions. Intermediate-frequency alignment is provided by fixed frequency switch positions of 456 kc and 465 kc. An audio outlet terminal is provided for supplying a 400-cycle signal externally. Weight of the instrument is 2 lb and price is \$32.95.

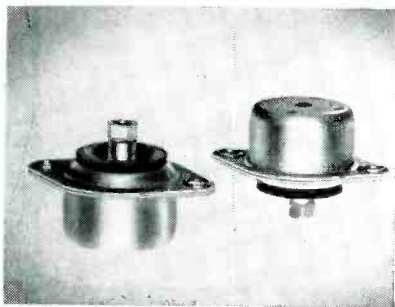

Air-Damped Mountings

THE BARRY CORP., 700 Pleasant St., Watertown 72, Mass. Series 6475 Barrymounts provide effective vibration isolation with all the ad-

vantages of air damping. Equipment supported on the mountings is raised only $\frac{1}{2}$ in. above the mounting surface. Unit mounts are 1 in. in diameter and have an overall height of 1 in. under minimum rated load. Load ratings range from 0.3 to 3.0 pounds per mount. The center stud is tapped to a depth of $\frac{1}{4}$ in. with an 8-32 thread.

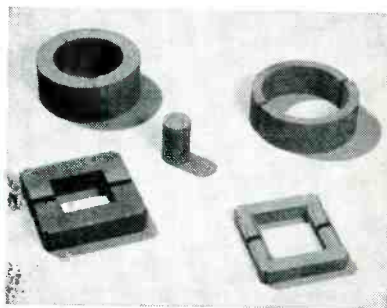

Noncritical Ferrites

FERRONCUBE CORP. OF AMERICA, 50 E. 41st St., New York 17, N. Y., has announced availability of high-permeability ferrite parts using noncritical materials. Transformer cores, deflection yoke cores, antenna cores, and permeability tuning cores for television and electronics are available in types 3 and 3C materials, which are nickel-free. Complete technical information is contained in engineering bulletin FC-5101.

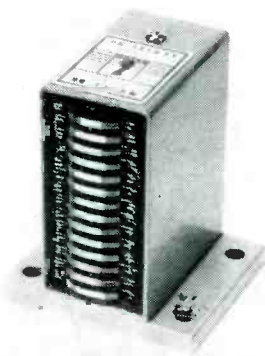

Record-Reproduce Head

THE BRUSH DEVELOPMENT CO., 3405 Perkins Ave., Cleveland 14, Ohio, has announced the BK-1500 series multichannel (available from 3 to 14 channels) record-reproduce head. Design features include balanced magnetic construction with

gaps at front and rear. All gaps are in perfect alignment and individual channels are cast into one integral block of specially selected synthetic resin. Complete assembly is nonmicrophonic and impervious to moisture. The head has a channel width of 0.050 in. with center-to-center spacing of 0.125 in.; gap is 0.0005 in. Maximum output level at 1,000 cps and 7.5 in. per second tape speed is 0.002 volt rms.

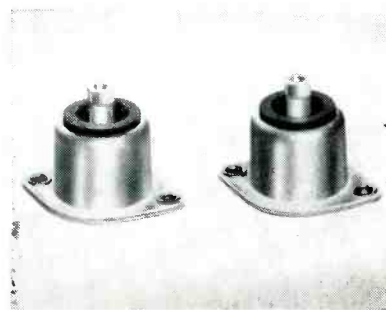

Shock and Vibration Isolators

THE BARRY CORP., 700 Pleasant St., Watertown 72, Mass. Series 6465 Barrymounts are designed to meet requirements for smaller isolators to be used with miniaturized equipment. The mountings employ air damping to minimize the shock of aircraft landing and taxiing and to limit excursion so that there is no snubber contact, even at resonance. Load ratings of bases using these mounts are 0.1 to 3.0 pounds per mount. The isolators are 1 in. in diameter and $1\frac{1}{2}$ in. high under maximum rated load. The attachment stud has an axial hole $\frac{1}{2}$ in. deep, tapped with 6-32 thread.

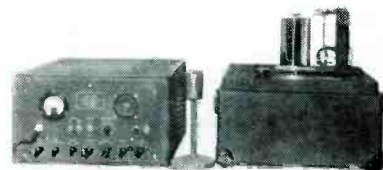

Vibration Analyzer

KAY ELECTRIC CO., Pine Brook, N. J. The Vibralyzer is applicable to the

(Continued on p 220)

For **MAXIMUM OUTPUT** with **MINIMUM DISTORTION**

you can't beat

audiotape

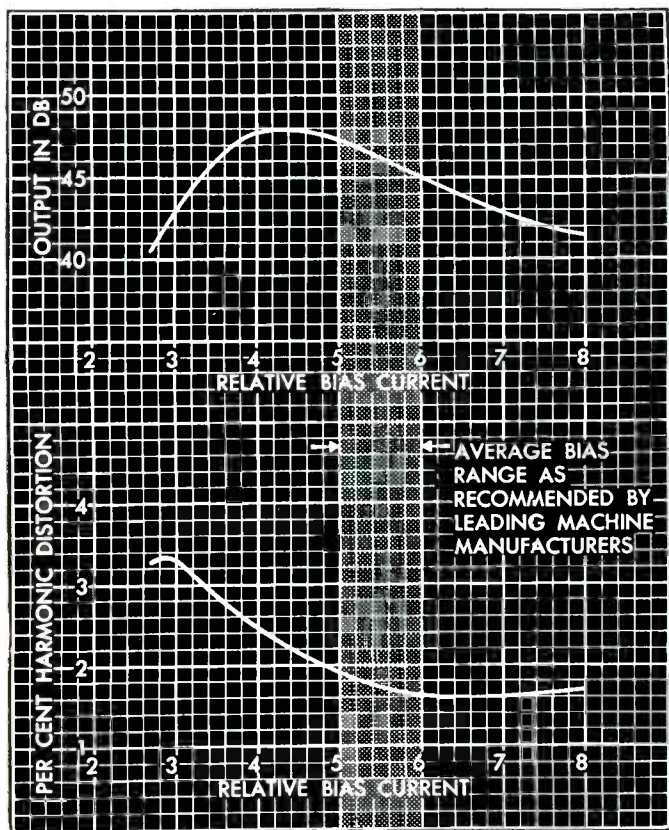

● As all professional recordists know, the proper operation of any tape recorder involves a compromise between *decibels* and *distortion*. And Audiotape has been especially formulated with this important relationship in mind—to give you higher output (and thus better signal to noise ratio) and lower distortion in the normal bias range of all machines.

Test it. Compare it with any other tape. Plot your own output vs distortion curves, similar to the ones shown above. You'll find that in the useful, low-distortion bias range, Audiotape combines maximum output with maximum fidelity and freedom from distortion.

That's just one of many reasons why more and more professional recordists are specifying Audiotape for their most exacting magnetic recording requirements. Remember—Audiotape is made *by* audio engineers, *for* audio engineers. *It speaks for itself.*

AUDIO DEVICES, Inc.

444 MADISON AVE., NEW YORK 22, N. Y.

Export Dept.: 13 East 40th St., New York 16, N. Y., Cables "ARLAB"

audiorecords audiotape audiofilm audiopoints

**And there's PROOF of
UNEQUALLED UNIFORMITY
in Every Package**

YOU GET an Esterline-Angus output curve in every five-reel package of plastic-base Audiotape. This curve, made from one of the reels in that package, actually measures the output characteristics of all five reels, since they are all slit from the same roll after coating. Now you can *see*, as well as *hear*, the exceptionally high output uniformity that you get only in Audiotape. What's more, every 1250-ft. and 2500-ft. reel is guaranteed **FREE FROM SPLICES!**

NEWS OF THE INDUSTRY

Edited by WILLIAM P. O'BRIEN

DPA Electronics Production Board Appointed

EDMUND T. MORRIS, JR., formerly with Westinghouse Electric Corp. in engineering and managerial capacities, has been appointed to head the Defense Production Author-



E. T. Morris, Jr.

ity's Electronics Production Board. Serving with him are: Capt. F. R. Furth, director of Naval Research Laboratory, Washington, D. C.; Harry A. Ehle, vice-president of International Resistance Corp., Philadelphia, Pa.; John G. Daley, chief of the Electronics Division, National Production Authority; M. W. Boyer, general manager of the Atomic Energy Commission; Don

G. Mitchell, president of Sylvania Electric Products, Inc., New York, N. Y.; and C. W. Middleton, vice-chairman for production of the Munitions Board.

The Electronics Board has the primary responsibility in DPA of assuring that electronics equipment is produced in sufficient quantities and on time to meet requirements of defense and essential civilian programs. Electronics is defined as including not only radio, tv and radar but also extensive application in other fields such as electric motors, fluorescent lighting, automobiles, business machines, fire control and industrial control devices, test and measuring equipment and communications equipment, as well as being an essential component of many basic weapons.

Britain's 1951 Radio Convention

THE British Institution of Radio Engineers' third convention will be held this year during the Festival of Britain. Six separate sessions,

to be held at intervals staggered over the period of the Festival, will cover almost the whole field of radio and electronic engineering.

Topic, time and place scheduled for each session are as follows:

Session 1—Electronic Instrumentation in Nucleonics—July 3 and 4, University College, London.

Session 2—Valve Technology and Manufacture—July 5 and 6, University College, London.

Session 3—Radio-Communication and Broadcasting—July 24 and 25, University College, Southampton.

Session 4—Radio Aids to Navigation—July 26 and 27, University College, Southampton.

Session 5—Television Engineering—August 21 to 24, King's College, Cambridge.

Session 6—Audio Frequency Engineering—Sept. 4 to 6, The Richmond Hall, Earls Court.

Amateur Radio to Aid Civil Defense

SUPPLEMENTING commercial communications facilities, the New York State Civil Defense Commission is forming a state-wide amateur radio system to be used for operations in atomic attacks when power or wire communications may be disrupted.

Colonel Lawrence Wilkinson, acting chairman and director of the Commission, has issued a bulletin to the 104 county and city C-D directors, urging them to enlist the support of qualified radio amateurs and their equipment for communications. Under the New York State Emergency Defense Act the State C-D Commission is empowered to control all communication facilities and personnel in event of an attack and during drills and tests prior and subsequent to an attack.

Control will be exercised through the enrollment of operators as members of the New York State Civil Defense Amateur Radio Service. This service will function under the policies, plans and instructions of the commission, of which Vincent T. Kenney is coordinator at the State C-D headquarters in New York City.

All local C-D directors in the

PRODUCING GERMANIUM DIODES

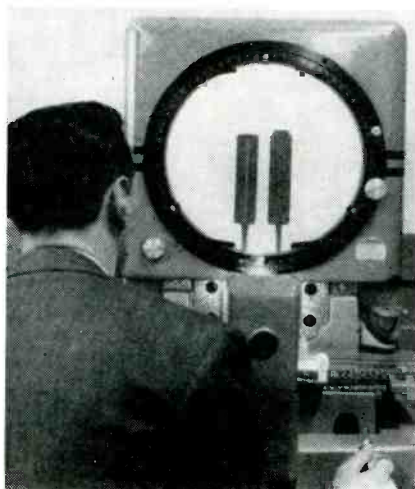

Girls use microscopes while welding whiskers to pin assemblies at GE's new germanium products plant in Clyde, N. Y. The new plant has a potential capacity of 12 million diodes annually. Photo at right shows a new contour projector in use at the plant. Here the whisker and pellet assemblies are inspected at a magnification of 20 times



WE'RE LIFTING THE BUSHEL BASKET— AND LETTING OUT OUR LIGHT!

Probably you didn't know it because we haven't told you. BUT—for the past five years we've been building car and truck radios for General Motors. In 1950 alone we built nearly 2,000,000 radios for practically all types of vehicles. Our production tops that of any other car radio manufacturer.

Since we stopped making radio and electronic equipment for the armed forces during World War II, we've concentrated on making our facilities the largest and our products the finest in the industry. Unlike most others, we're not just an assembly plant. We make practically all the parts that go into our products. Our design and research engineers are tops in their field. Our laboratory and production equipment is the finest that can be obtained.

With our vast experience, our facilities, engineering know-how, our productive manpower bigger and better than ever before, we believe we can be of service to our country. We are ready to go to work immediately for national defense and count it a privilege to volunteer for service.

Delco Radio

DIVISION, GENERAL MOTORS CORPORATION
KOKOMO, INDIANA

State have been informed that a trained nucleus of operating personnel can be obtained from the New York members of the Amateur Radio Emergency Corps, an affiliate of the American Radio Relay League.

Powdered Iron Core Dimensions Standardized

ALL of the types of cores made from iron powder and commonly in use by the radio and television industry have been listed in a new Standard just released by the Metal Powder Association. The Standard was prepared by the Electronic Core Subcommittee of the Metal Powder Association Standards Committee to meet a long felt need in the pulverized core industry for standardization of dimensions and tolerances.

The Standard, designated 11-51-T, defines the terms commonly associated with cores made from powdered magnetic materials and specifies the preferred dimensions of standard sizes and shapes. Preferred dimensions are listed in detail for plain iron cores, insert iron cores, threaded iron cores, tuning cores and sleeve iron cores. In addition to diameters and lengths, data is provided for concentricity, screw-driver slot dimensions, hexagonal hole sizes as well as threaded spring type and spaded insert sizes.

Developed after careful consideration by the members of the Electronic Core Subcommittee, it reflects, in substance, the practices established by the RTMA. Members of the Electronic Core Subcommittee include the following companies: Empire Coil Co. of New Rochelle, N. Y.; Magnetic Core Corp., of Ossining, N. Y.; National Moldite Co. of Hillside, N. J.; Powdered Metal Products Corp. of Franklin Park, Ill.; Pyroferric Co. of New York, N. Y.; Radio Cores, Inc., of Oak Lawn, Ill.; Speer Resistor Corp. of St. Marys, Pa.; and Stackpole Carbon Co. of St. Marys, Pa.

William E. Cairnes, president of Radio Cores, Inc., is chairman of the subcommittee.

Copies of the new Standard and other Standards published by the

MEETINGS

AUG. 15-18: 1951 APCO Conference, Everglades Hotel, Miami, Florida.

AUG. 20-23: AIEE Pacific General Meeting, Multnomah Hotel, Portland, Oregon.

AUG. 22-24: Seventh Annual Pacific Electronic Exhibit and West Coast Annual IRE Convention, San Francisco Civic Auditorium, San Francisco, Calif.

AUG. 28-SEPT. 8: Eighteenth British National Radio Show, Earls Court, London, England.

SEPT. 10-14: Sixth National Instrument Conference and Ex-

hibit, sponsored by Instrument Society of America, San Houston Coliseum, Houston, Texas.

OCT. 8-10: AIEE Conference on Aircraft Equipment, Hollywood Roosevelt Hotel, Los Angeles, Calif.

OCT. 22-24: 1951 National Electronics Conference, Edgewater Beach Hotel, Chicago, Ill.

OCT. 22-26: AIEE Fall General Meeting, Hotel Cleveland, Cleveland, Ohio.

Nov. 12-15: NEMA Convention, Haddon Hall, Atlantic City, N. J.

Metal Powder Association may be obtained by writing to the Association at 420 Lexington Ave., New York 17, N. Y., and enclosing 25 cents per copy.

Harbor-Control Radar Tested

PORT of New York Authority, operated jointly by the states of New Jersey and New York, has inaugurated an experimental program to test the feasibility of harbor-control radar as an aid to pilotage during foggy weather.

Shore-based radar installations are now in regular service at Liverpool, England, and Long Beach, California. They are operated experimentally in the harbors at San Francisco and Baltimore. Other installations are under construction in Le Havre, France, and Southampton, England.

Although no figures are available at present to show the savings that might result with this navigational aid, it is known, for example, that the fixed cost of delaying a 10,000-

(Continued on page 238)

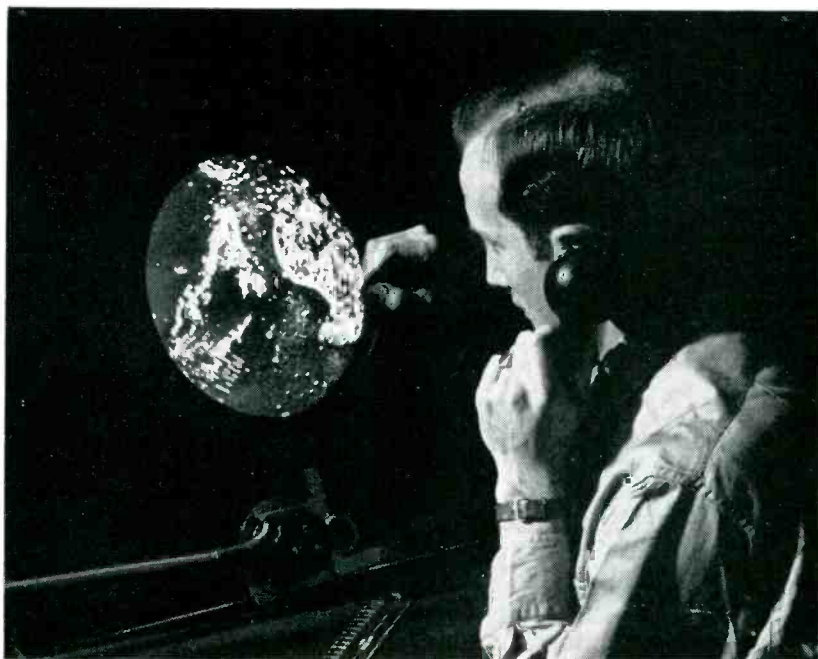

Scope presentation of the New Jersey-New York harbor from Fort Wadsworth, Staten Island, overlooking the Narrows. Ships, islands, buoys and shore lines between Ambrose Light and the Battery are clearly visible

Sylvania Tubes help keep U. N. Building free from smoke

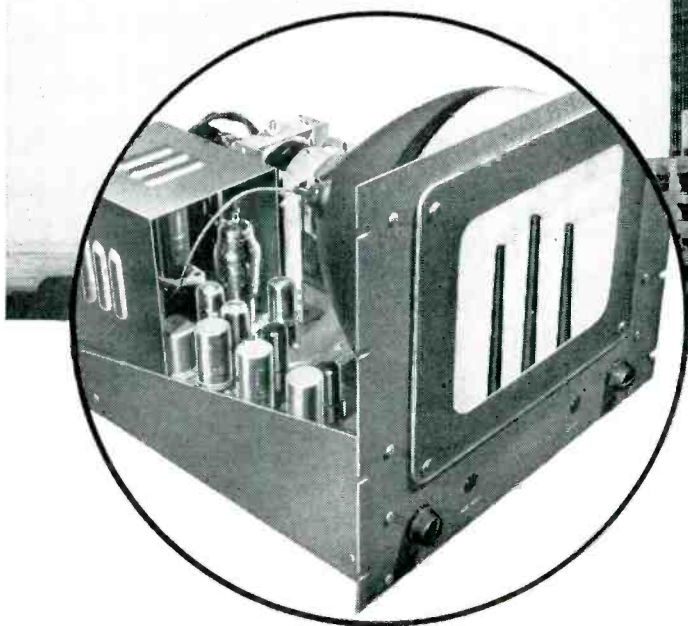

Showing chassis of "Vericon" Picture Monitor equipped with Sylvania tubes. These monitors are finding a wide variety of uses today in industries and institutions. They were designed to the exacting requirements of the Remington Rand "Vericon" System and built by Television Utilities Corp.

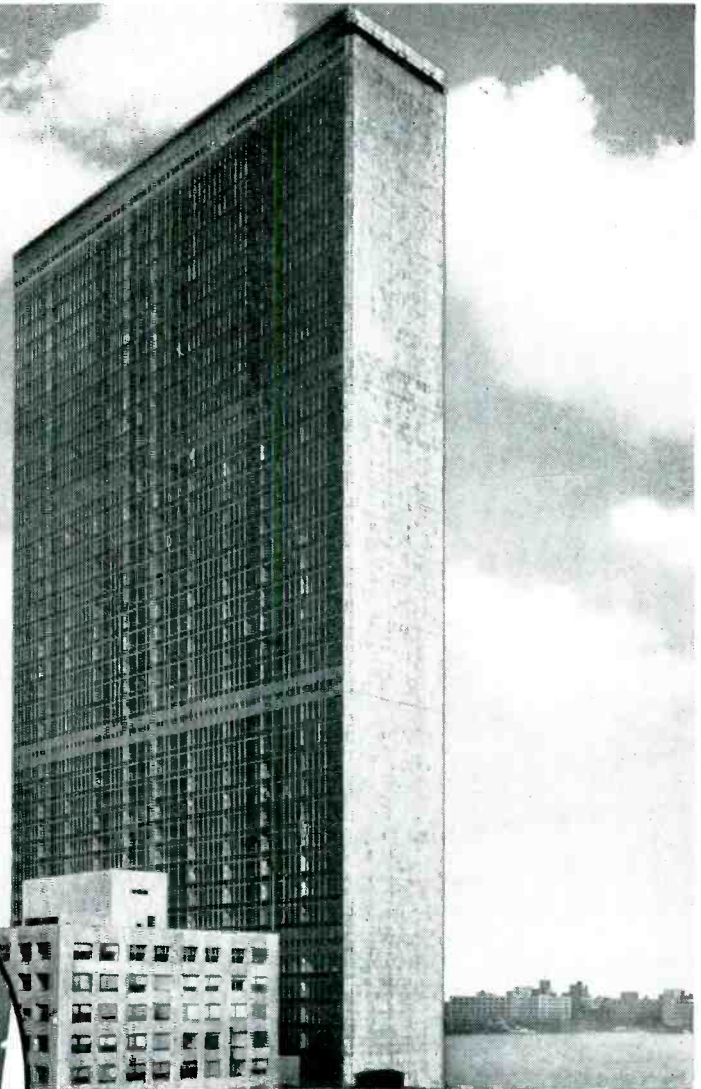

The problem of smoke at New York's beautiful U. N. Area is being solved with the help of Remington Rand's "Vericon" Industrial Television System equipped with Sylvania Tubes.

In reaching a satisfactory solution, much credit goes to the Consolidated Edison Company, located near by, for their all-out cooperation. Among other preventive measures, this company installed and focused a set of Remington Rand "Vericon" TV cameras on their towering stacks.

These cameras are hooked up to five strategically located viewing monitors—(soundless TV sets)—made by Television Utilities Corp. and equipped with Sylvania picture tubes and receiving tubes.

Every day, these monitors are in operation. If at any time smoke should appear, Consolidated Edison observers on watch immediately operate special controls to clear up the situation.

Writes Mr. A. E. Siegel, President of Television Utilities: *"Our monitors have been running all day long without stop for more than three months. All are equipped with Sylvania radio and picture tubes. We are wondering how long the Sylvania tubes will continue to take this kind of abuse without talking back."*



The above is another interesting record of the durability and excellent performance of Sylvania tubes. Let us tell you something about the reasons behind this quality. For full technical data about any types of Sylvania receiving, transmitting, or picture tubes write today to: Sylvania Electric Products Inc., Dept. R-1107, Emporium, Pa. Sylvania Representatives are also located in all foreign countries.



SYLVANIA ELECTRIC

TELEVISION PICTURE TUBES; RADIO TUBES; ELECTRONIC PRODUCTS; ELECTRONIC TEST EQUIPMENT; FLUORESCENT TUBES, FIXTURES, SIGN TUBING, WIRING DEVICES; LIGHT BULBS; PHOTOLAMPS; TELEVISION SETS

Electra carbon-coat

PRECISION

RESISTORS

They're
NEW
PRECISION...
1% Tolerance

**deposited
carbon
resistors**

The right choice for **ACCURACY** ... **ECONOMY** ... and **STABILITY** in circuits where wire wound resistors are often times too expensive and the characteristics of carbon composition resistors are not suitable. Deposited carbon resistors are especially adapted to high frequency applications that require high stability and close tolerance of resistance values. Manufactured to customer's specifications. For complete data mail coupon.

ELECTRA MFG. COMPANY
RESISTOR DIVISION

2537 Madison Ave. • Kansas City 8, Mo.

FOR 25 YEARS A MANUFACTURER OF
PRECISION ELECTRICAL EQUIPMENT

ELECTRA MFG. COMPANY
2537 Madison Ave. • Kansas City 8, Mo.

Please send Bulletin E-1—Complete Data
on Deposited Carbon Resistors.

NAME _____

COMPANY _____

ADDRESS _____

CITY _____

STATE _____

NEW BOOKS

Piezoelectric Crystals and Their Application to Ultrasonics

By WARREN P. MASON. *D. Van Nostrand Co., Inc., New York, 1950, 508 pages, \$7.50.*

THE RECENT book by Dr. Mason constitutes a noteworthy addition to his many publications and contributions in this highly specialized field. Not intended for swift or easy reading, this work will become a reference to workers in the field, as opposed to a descriptive treatment for those wishing an elementary survey.

In the opening chapters are developed the basic expressions for the elastic, piezoelectric, pyroelectric, and dielectric relations of sol-

RELEASED THIS MONTH

Electronic Motor and Welder Controls; G. M. Chute; McGraw-Hill; \$6.50.

Elements of Television Systems; G. E. Anner; Prentice-Hall; \$10.35.

Synthesis of Electronic Computing and Control Circuits; Harvard University Press; \$8.00.

ids. Coupled with a concise treatment in the appendix, wherein these relations are erected in tensor form, the development leads to the establishment and individual listing of the fundamental mathematical forms of the seven groups and thirty-two classes into which all crystals fall, as determined by their physical properties and symmetry properties.

The major part of the book summarizes the work and findings of the Bell Laboratories resulting from their many years of significant research in this field. The properties of quartz and rochelle salt are described, but main emphasis is given to such new crystal developments as dipotassium tartrate (DKT), ethylene diamene tartrate (EDT), ammonium dihydrogen phosphate (ADP), potassium dihy-

(continued on page 254)

FLEXLOC

SELF-LOCKING NUTS

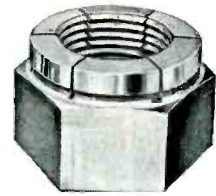

STAY

TIGHT

AFTER

171,360,000

VIBRATIONS AT 4000
CYCLES PER MINUTE...

Plain nuts with lock washers loosened after only ONE HOUR of 4000-cycle-per-minute operation on the vibrator of a concrete block machine at the plant of the Bethayres Concrete Block Co., Bethayres, Pa.

When FLEXLOC Self-Locking Nuts were installed, they were *still tight* when the machine was torn down for rebuilding after 6 weeks operation—at 4000 C.P.M., 17 hours a day, 7 days a week!

If you have an application where nuts loosen or back off, try FLEXLOC, the one-piece, all-metal STOP- and LOCK-NUT "that won't work loose."

Send for Bulletin 619-A today.

—SPS—

STANDARD PRESSED STEEL CO.
JENKINTOWN 10, PENNSYLVANIA

Let
Bendix
 Solve Your
 Problems

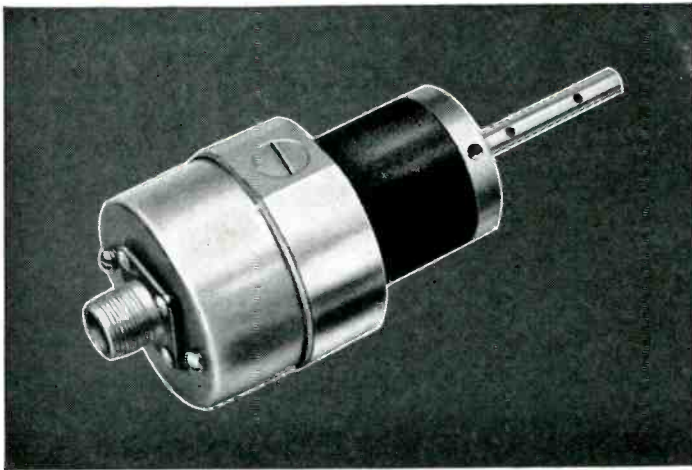
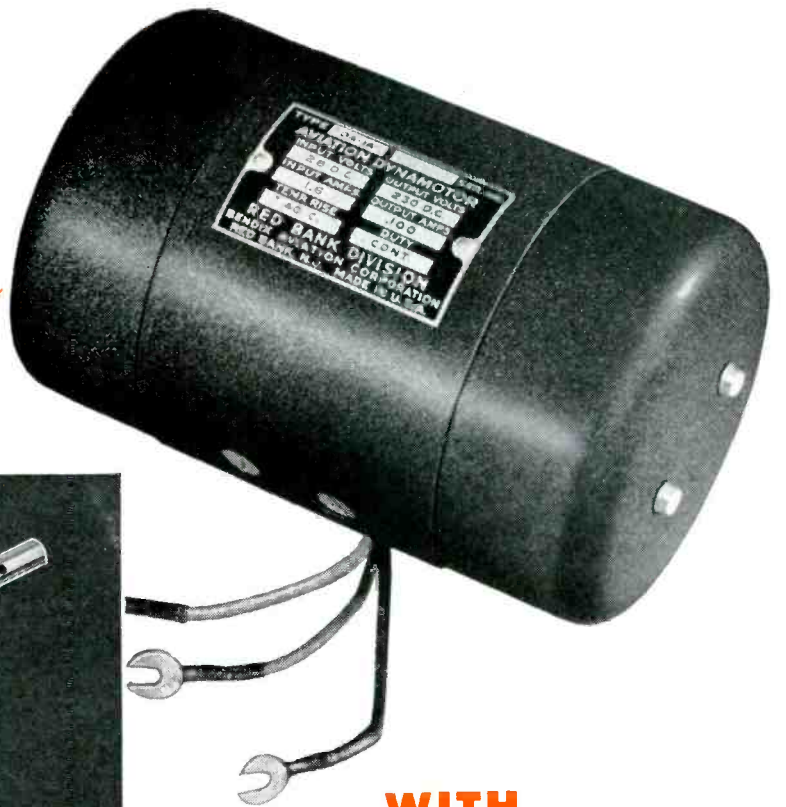

When you are faced with specifications that place impossible requirements on dynamotors or small DC motors, according to World War II standards, take advantage of recently developed improvements in high temperature and high altitude techniques by simply outlining your requirements to Bendix. Model units *exactly* meeting your performance specifications will be developed and tested for pre-production use—production units will then follow in accordance with your manufacturing schedule.

WITH
**SPECIALIZED
 DYNAMOTORS**
 AND
DC MOTORS

- DYNAMOTORS**
 Regular • Multiple output • Special purpose
- DC MOTORS**
 1/100 hp—1/2 hp • Continuous and Intermittent Duty
 DC Servos and special motors

RED BANK DIVISION OF BENDIX AVIATION CORPORATION
 RED BANK, NEW JERSEY
 Export Sales: Bendix International Division, 72 Fifth Avenue, New York 11, N.Y.

Write for this colorful and informative book
 —it's free. You'll find it loaded with facts
 and figures about all types of dynamotors.



Where the
Requirements
are Extreme...

Use SILVER GRAPHALLOY

For extraordinary
electrical performance



THE SUPREME BRUSH
AND CONTACT MATERIAL

for BRUSHES

- for high current density
- minimum wear
- low contact drop
- low electrical noise
- self-lubrication

for CONTACTS

- for low resistance
- non-welding character

Graphalloy is a special
silver-impregnated graphite

Accumulated design experience counts —
call on us!

GRAPHITE METALLIZING CORPORATION

1055 NEPPERHAN AVENUE, YONKERS 3, NEW YORK

Backtalk

This department is operated as an open forum where our readers may discuss problems of the electronics industry or comment upon articles which **ELECTRONICS** has published.

Familiar Music

DEAR SIRs:

I HAVE READ with considerable interest Robert M. Strassner's article on Gas-Diode Electronic Organs in **ELECTRONICS** for January, 1951.

You undoubtedly will be interested to hear that the principle disclosed in the article is by no means original with Strassner but has been developed by me approximately 17 years ago, together with Francis R. O'Leary my assistant at that time. In this connection, your attention is directed to O'Leary patent 1,986,599 and Langer patent 2,252,189, copies of which accompany this letter.

To complete the references appearing at the end of Strassner's article, I would like to add the following complete list of my pertinent patents which resulted from my experimental work on gas-diode electronic musical instruments extending over the period of nearly a quarter of a century:

1,832,402	2,044,360
1,937,389	2,247,728
1,993,890	2,252,189
2,017,542	2,365,566
2,035,238	2,365,567
2,039,651	2,365,568
2,040,439	2,403,664

NICHOLAS LANGER
New York, N. Y.

Medical Electronics

DEAR SIRs:

FOR SOME TIME I have felt the need for an organization to bring together those of us who are working in the field of medical electronics. This was further confirmed by the

(Continued on page 268)

NEW ONE-PACKAGE CONTROL SYSTEM

for
DIFFERENTIAL TRANSFORMERS
or
STRAIN GAGES
at the Flip
of a Switch



DYNA-MYKE

The Dyna-Myke Model 129-B is a precision, high speed, dynamic micrometer using linear differential transformers as the sensing element. It measures and provides for recording such phenomena as force, torque, strain, vibration, acceleration, temperature, pressure, thickness, surface finish, etc., with a linear frequency response of DC to 1000 cps. Direct displacements are measured in five ranges from ± 1 inch to ± 10 micro inches. On standard magnetic recorders a sensitivity of 1 micro inch per millimeter is available. A toggle switch converts the Dyna-Myke to a high frequency, high sensitivity strain gage indicator. The output is used to drive any type of magnetic, null balance or galvanometer recorder—or the DC or modulated carrier may be viewed on an Oscilloscope. Selsyn motors may be driven for remote indication or control. Request Technical Bulletin 129-B for full details.

DYNA-METER



The Dyna-Meter Model 144, when used with the Dyna-Myke, indicates by neon lights the peak amplitude of transients as fast as 1 millisecond. This indication may be instantaneous or a memory feature may be used to maintain the reading until reset. Built-in power relays provide on-or-off control to any plus or minus limits established by the Dyna-Myke. The combination of the Dyna-Myke and the Dyna-Meter offers many applications to industrial processes resulting in the elimination of scrap at the source. Uses in connection with machine tool operations are particularly impressive. Request Dyna-Meter Technical Bulletin 144.

Custom Builders of Electronic Instruments Since 1943



INDUSTRIAL ELECTRONICS, INCORPORATED

Wheeler St., Detroit 10, Mich.

July, 1951 — **ELECTRONICS**



“Fourteen little superintendents . . .”

Fourteen little angels with eyes glued to the home movie screen. A well planned birthday party proceeding according to schedule. Then . . . pfft . . . and the projector stops. At once fourteen little angels change to fourteen little devils. Pity the poor host, a mechanical dud, trying to figure out what's wrong. Add fourteen little superintendents and a few assorted mothers, all anxious to take an active part—the perfect set-up for male frustration. When the repairman gets around—after a few days—and the trouble turns out to be electrical insulation failure . . . there goes a projector manufacturer's reputation, for a few pennies saved by using an inferior insulation.

Electrical insulation is a decisive factor in successful product operation.

Add extra protection and longer life to your products with BH Extra Flexible Fiberglas* Sleeving (Ex-Flex to the industry.)

Ex-Flex Fiberglas Sleeving has unusual non-fraying properties, obtained independent of the saturant. It can be cut in short lengths, yet will not fray in handling. Its

tubular shape makes it easy to handle. It spreads readily over knobs, terminals and irregular objects.

Tough and long lasting, Ex-Flex Fiberglas Sleeving has perpetual flexibility, under all conditions of temperature and aging, because no hardening varnish is used.

Look at these other features too—available in colors—non-combustible—maintains physical and dielectric properties from -70°F to $+1200^{\circ}\text{F}$, with color retention up to 300°F —resists abrasion and wear.

BH Ex-Flex Fiberglas Sleeving is one of a family of electrical insulations, each designed to meet particular conditions in service. Give us a few facts about your requirements—product, temperatures, voltages—we will gladly furnish free samples for testing purposes.

Address Dept. E-7
Bentley, Harris Manufacturing Company
Conshohocken, Pa.

BH *Fiberglas** SLEEVINGS

*BH Non-Fraying Fiberglas Sleeveings are made by an exclusive Bentley, Harris process (U. S. Pat. No. 2393530). "Fiberglas" is Reg. TM of Owens-Corning Fiberglas Corp

IN BUSINESS



SINCE 1904

Wire for Defense Projects!

HOOK-UP WIRES and CABLES for COMMUNICATIONS EQUIPMENT and ELECTRONIC INSTRUMENTS

FOR almost a half century Lenz has been producing insulated Wires and Cables for the Communications Industries, wires that are engineered and designed under high quality standards.

Now, Lenz is prepared to furnish hook-up wire and cables for defense projects, conforming to Government specification JAN-C-76 TYPES WL, SRIR and SRHV. These Thermo-Plastic Insulated Wires, with or without Lacquered Braids, and the cables constructed of same, are available for use in Communications Equipment and Electronic Instruments.

For a dependable source for your wire and cable requirements, consult Lenz.

CONFORMING TO
JAN-C-76
TYPES WL, SRIR and SRHV

IN THE AIR



ON LAND



ON THE SEA

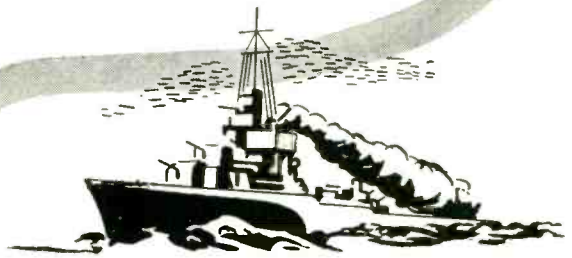

LENZ ELECTRIC MANUFACTURING CO.

1751 No. Western Ave. • Chicago 47, Illinois



ANOTHER **RMC** FIRST

... a New and Better Capacitor That Answers the UHF Inductance Problem

DISCAP®

"SOLDER-INS"

Of special importance to the ultra high frequency TV receiver designer is the problem of inherent inductance found in standard capacitors. Tests show that the inductance of a Hi-K by-pass ceramic disc is very low but, when wire leads are used for mounting, the inductance increases with the length of the leads.

RMC "Solder-ins" are low-cost presoldered, silvered ceramic disc capacitors which can be soldered directly between ground and a tube socket lug or, in fact, to any vital by-pass point. The effect is to cancel lead inductance, providing a minimum of over-all inductance.

RMC DISCAP "Solder-ins" are available in capacities between .000010 and .0015 MFD.

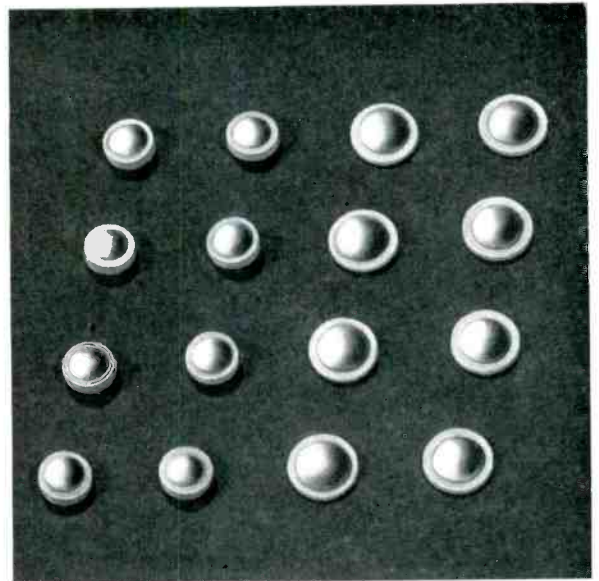

SEND FOR DISCAP SAMPLES IN THE CAPACITIES YOU ARE USING

Are You Using RMC By-Pass and Temperature Compensating DISCAPS?

RMC Type B-GMV by-pass DISCAPS are available in single and dual units in a full range of capacities between .008 and .02 MFD. Their wide use throughout radio and TV is proof of their superiority.

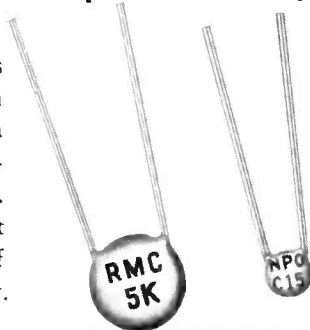

Approved and used by leading TV and electronic producers. RMC Type C temperature compensating DISCAPS are designed to replace tubular ceramic and mica condensers at *lower cost.*

DISCAP
CERAMIC
CONDENSERS



RADIO MATERIALS CORPORATION

GENERAL OFFICE: 1708 Belmont Ave., Chicago 13, Ill.

FACTORIES AT CHICAGO, ILL. AND ATTICA, IND.

Two RMC Plants Devoted Exclusively to Ceramic Condensers

AN approved (3303-1)



R-B-M

ELECTRONIC AND COMMUNICATION RELAYS

Now Hermetically Sealed

HUNDREDS of thousands of R-B-M telephone type relays saw Government service in World War II. Now most of these relays are available in hermetically sealed enclosures designed to meet AN specifications.

R-B-M hermetically sealed telephone type relays are available in contact forms up to and including 4-pole, double throw, 3 ampere, 28 Volts D. C. construction. Also 10 ampere rating up to and including 2-pole double throw at 28 Volts D.C. All relays available with approved AN plug connector, or with solder connections.

Engineers! What is YOUR hermetically sealed relay requirement? R-B-M is developing new and smaller relays to meet Armed Services requirements. Perhaps one of these will solve your problems. Write giving complete relay specifications, application, quantity and AN specifications applying. Address Dept. F-7.



AN approved (3304-1)

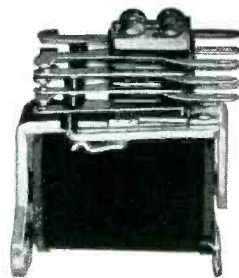

R-B-M Production and Engineering facilities in two plants, located in different states, (over a quarter million square feet), can assist you in the development and production of special electro-magnetic devices for Armed Services application.

TUBES AT WORK

(continued from page 138)

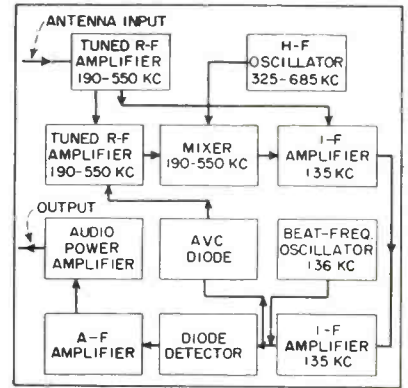

Block diagram of the receiver. Compactness is achieved through use of subminiature components

they are double-tuned and use permeability-tuned inductors of about 2.8 millihenries which have Q's of 70 at 135 kc. The resonating capacitors are washer-shaped and mounted in the ends of the transformers. The r-f coil structures resemble those of the i-f transformers so that similar parts may be used in both.

Panel controls involved a design problem. The small size of the panel (5½ by 1½ inches) and the need for hermetic seals made it undesirable to have more than two external controls. Since one of these was required for tuning, the other had to fill the three distinct functions of gain control, power on-off switch and beat-frequency-oscillator on-off switch. All these latter functions are performed by a special compact switch, designed to be produced entirely by stamping operations.

The specially designed miniature gain control uses a high-temperature adhesive-tape resistor, also developed by NBS. The tape is applied around a small glass cylinder, ⅜ inch in length and ½ inch in diameter, on which 120 axial lines of silver paint have been deposited to form commutator segments. A precious-metal brush makes contact with the projecting ends of these silver lines.

Aside from its inherent usefulness as an ultra compact piece of airborne communication equipment, the new range receiver has also served as the focal point for the development of several novel components and fabrication techniques. These components, engineered to



**R-B-M DIVISION
ESSEX WIRE CORP.**
Logansport, Indiana

MANUAL AND MAGNETIC ELECTRIC CONTROLS
— FOR AUTOMOTIVE, INDUSTRIAL, COMMUNICATION AND ELECTRONIC USE

NEW GL-6044 THYRATRON FEATURES

NEW BASE CONSTRUCTION

—stronger, safer,
steadier!



Study these important design plusses:

TIGHT, DEPENDABLE CONTACTS.

Bolted electrical contacts are firm and substantial. There are no springs to relax because of heat. No risk of the tube slipping from its socket due to vibration.

HIGH-TEMPERATURE OPERATION.

Since the GL-6044 has no base in the customary sense, the tube's operating temperature is not limited by decomposition of a basing compound.

BUILT-IN STURDINESS. *Strength* marks every detail. The tube is short and compact. Its internal structure is solidly braced. Thimble-type terminal seals, of fernico-to-glass construction, are long-

lived, resist strain. Contact fingers, extending out from the tube, have a factor of resilience which helps to ward off shocks.

CLEAN EQUIPMENT LAYOUT. GL-6044 installation involves no cumbersome conventional socket. No provision need be made for a top anode terminal connection, since all leads come out at the bottom of the tube.

SPACE-SAVING. GL-6044's are *only half the height* of 5528 thyratrons —yet rated the same! They will mount more closely side-by-side; their bolted terminals can be inter-arranged on a panel so that the tubes are compactly grouped.



GL-6044 6.4-amp thyatron

Inert-gas-filled, for efficiency within the wide ambient temperature limits of -55°C to approx 120°C (at normal atmospheric pressures). Designed for use in aircraft, but also available for industrial control applications . . . Wire or write today for Bulletin ETD-155, giving ratings and performance facts! *Electronics Dept., Sec. 3, General Electric Company, Schenectady 5, N. Y.*

GENERAL ELECTRIC

180-K3

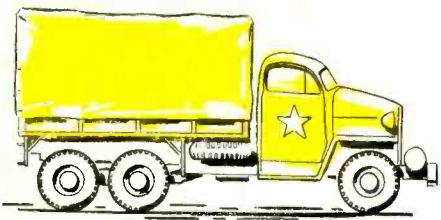

MAGNECORD *Sound Research*

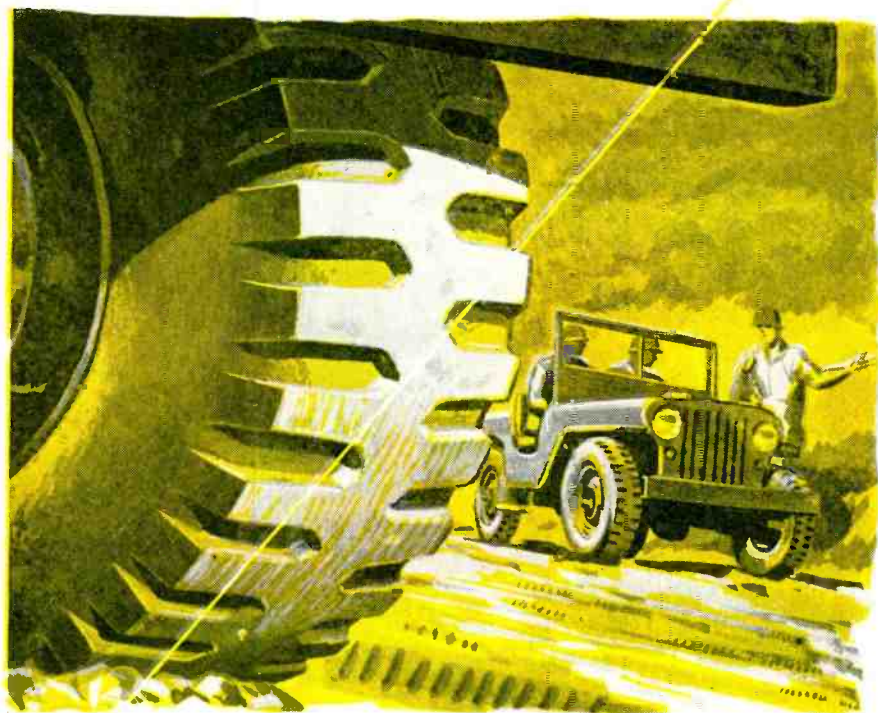

SENDS A TIRE TO THE FRONT

Tough mud-slogging tires roll our forces toward the front. Behind rugged-duty tires lie months of sound research with Magnecord tape recorders . . . vibration tests to determine the wear and performance of new tires in development. Precision testing demands the finest precision tape recording.

Whatever your recording problem, Magneorders offer greater flexibility, fidelity, features. Available for subsonic, audio or supersonic research, Magnecord can fill your most exacting requirements.

Used by more engineers than all other professional tape recorders combined.

Magnecord, INC.
HIGH FIDELITY TAPE RECORDERS FOR INDUSTRY

Write for New Catalog

Magnecord, Inc., Dept. EA-7
360 N. Michigan Ave., Chicago 1, Ill.

Send me further information on Magnecord tape recording for industrial "Sound" Research.

Name.....
Company.....
Address.....
City..... Zone..... State.....

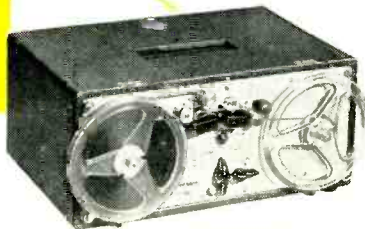

meet the rigorous size and temperature requirements of subminiature equipment, may well afford superior permanence and reliability when used in equipment of more conventional and less compact design.

Reducing Transmitter Out Time

BY JAMES H. GREENWOOD
*Station WCAE, Inc.
Pittsburgh, Pa.*

CONTINUITY of service is important to a radio station and the listening public. A minute of silence in the middle of a program may destroy the continuity and annoy the listeners, many of whom would tune in another station.

All of the facilities at WCAE are installed at least in duplicate. Lost time therefore becomes only that time required to isolate the unit in trouble and switch to the alternate unit. This time may be subdivided into four categories; time in which the existence of trouble is observed and realized, time in which to classify or locate the trouble and determine its seriousness, warm-up time for the alternate equipment and actual time involved in switching the alternate equipment into service.

The distribution of time among these classifications varies widely for different types of failure. For some components, the diagnosis and replacement are completely automatic; for others, the human element enters into each step of the process.

At one time, the emergency transmitter at WCAE consumed 45 seconds in warming up. Switching it into service could be accomplished during this time. However, the human element entered into the first two categories mentioned previously and another 15 seconds was added, bringing the total time lost on each occasion of transmitter failure to approximately one minute.

The one-minute loss time has now been reduced to between 12 and 15 seconds. On the surface, it appears to be a gain of four to one but in listener reaction the gain is

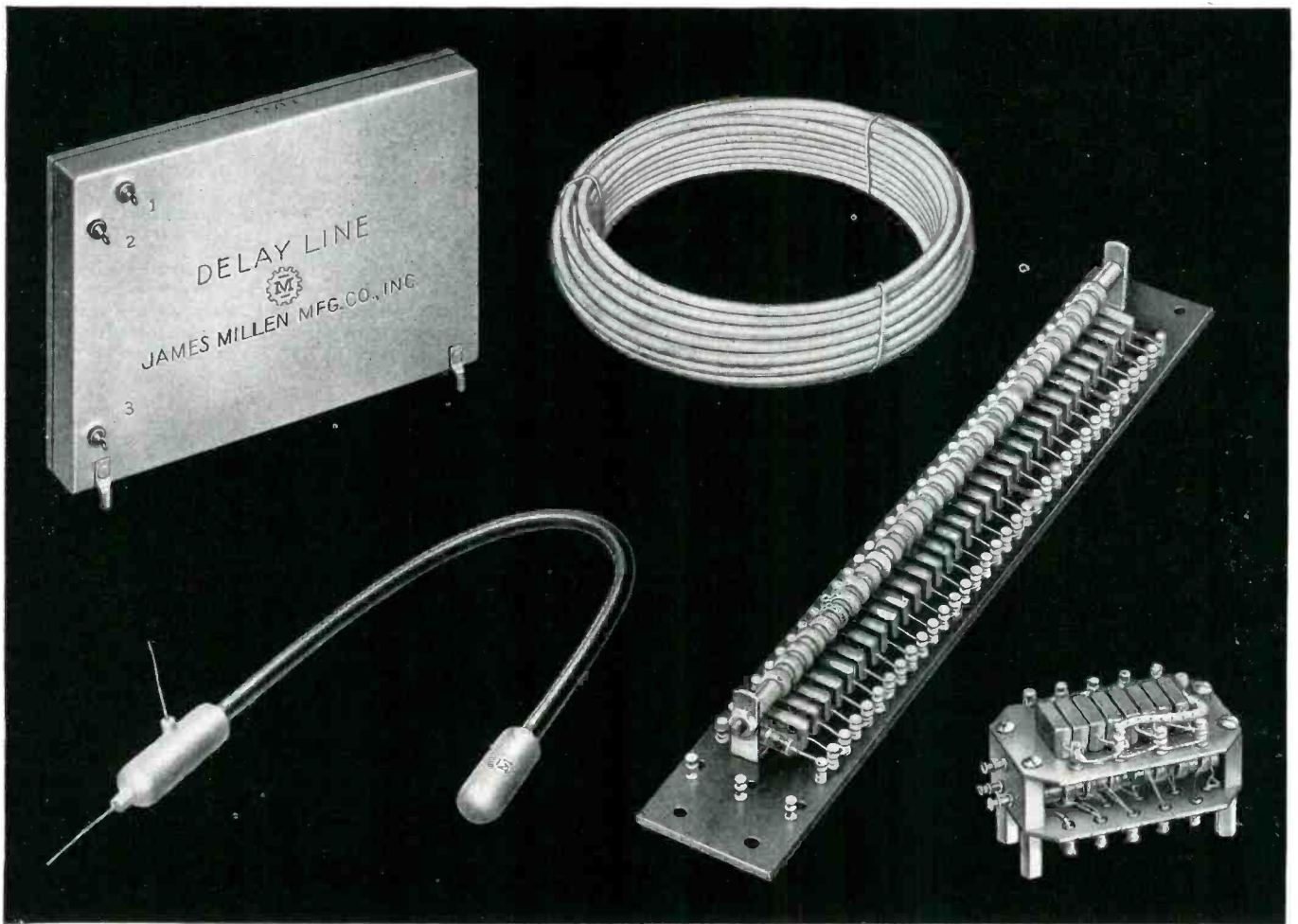

"Designed for Application"

Delay Lines and Networks

The James Millen Mfg. Co., Inc. has been producing continuous delay lines and lump constant delay networks since the origination of the demand for these components in pulse formation and other circuits requiring time delay. The most modern of these is the distributed constant delay line designed to comply with the most stringent electrical and mechanical requirements for military, commercial and laboratory equipment.

Millen distributed constant line is available as bulk line for laboratory use and in either flexible or metallic hermetically sealed units adjusted to exact time delay for use in production equipment. Lump constant delay networks may be preferred for some specialized applications and can be furnished in open or hermetically sealed construction. The above illustrates several typical lines of both types. Our engineers are available to assist you in your delay line problems.

JAMES MILLEN  **MFG. CO., INC.**

MAIN OFFICE

AND FACTORY

MALDEN, MASSACHUSETTS, U. S. A.

GRAPHITE ANODES

for

BETTER TUBE PERFORMANCE

Because of their durability under heat extremes plus their low secondary emission, Stackpole Graphite Anodes find widespread use in rectifier tubes and, in many cases, surpass hard-to-get molybdenum, tungsten and tantalum anodes in power tube applications. High heat conductivity prevents hot spots with resultant warping. Moreover, graphite permits higher plate power dissipation and safely withstands severe overloads.

As long time specialists in this field, Stackpole regularly produces dozens of anode types—each manufactured by special processes which assure high uniformity and reduce "gassing" from dust or impurities to a negligible minimum.

STACKPOLE CARBON COMPANY
St. Marys, Pa.

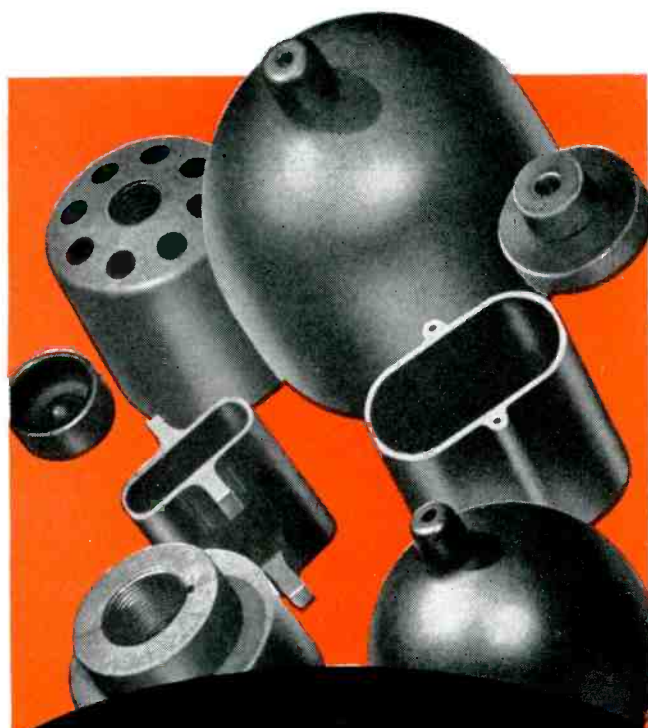

STACKPOLE

"EVERYTHING IN CARBON BUT DIAMONDS"

TUBES AT WORK

(continued)

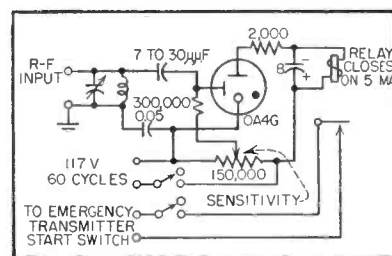

FIG. 1—Schematic diagram of the circuit for starting the emergency transmitter automatically whenever the carrier is interrupted

much greater, for the first quarter minute of silence is not nearly as annoying as the fourth.

Reduced Warm-Up Time

Warm-up time was reduced to 12 seconds by applying heater current continuously to all heater-type tubes. This practice has not resulted in any observable reduction in useful tube life since only one heater-type tube has been replaced for any cause since 1939 when the system was installed in its original form.

The human element was removed from observing and realizing the existence of trouble by additional circuitry, as shown in Fig. 1. A small sampling antenna and tank circuit excite the grid of an OA4G. In its plate circuit is a relay which starts the emergency transmitter warm up whenever the r-f grid excitation falls below a safe, preset value. This relay does not apply plate voltage to the emergency transmitter.

If the loss of carrier is caused only by a momentary flashover within a tube or a transient arc caused by a lightning discharge, there is no need for the emergency transmitter and the operator merely shuts it off instead of completing the transfer. Observance of the nature and seriousness of the trouble is accomplished while the equipment is warming up and by the time the decision has been made, the equipment is ready for use.

To reduce the time necessary to switch the alternate equipment into operation, some of the operations performed had to be simplified. The original switching operation consisted of the following steps: removing final-stage plate voltage from the transmitter being taken

She SINGS... She LAUGHS

She TALKS... She PRAYS

...all because of the **STROBOTAC**

This Effanbee Doll, manufactured by a division of the Noma Electric Company, is the pride and joy of thousands of little (and big) girls. She is made vocal by means of a very cleverly designed, "built-in" talking machine, the heart of which is a miniature electric motor which operates on 2 standard flashlight batteries.

The batteries, motor, small phonograph turntable, minute record, pick-up and loudspeaker are housed in a plastic container inside the doll. A touch of a concealed button and the doll speaks, whether standing, lying or sitting down.

The small, precision-built motor has to be held to

a speed between 4350 and 4550 rpm in manufacture. It is impossible to measure its speed with a mechanical tachometer. Blake Manufacturing Corporation of Clinton, Massachusetts, who make the motors, use four STROBOTACS in test jigs to check the speed of these motors as they move through production. Any motor which does not meet the speed limits is rejected.

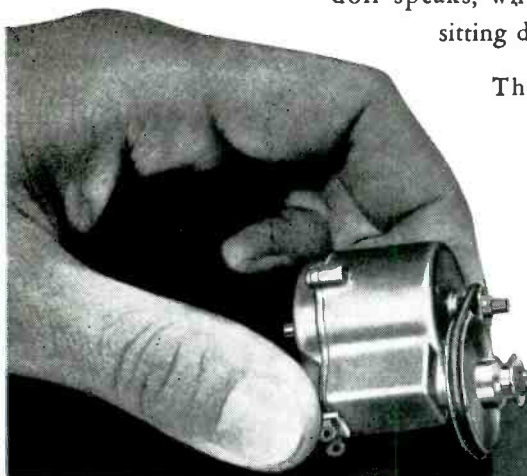

Simple test jigs hold Blake motors while their speeds are checked in three motor positions by STROBOTACS mounted above them. A small plastic sleeve, marked with a black indicating line is slipped over the motor shaft to be "stopped" by Strobotac measuring motor speed within 1%.



Type 631-B
STROBOTAC

Direct-Reading Speed Range: 600-14,400 per minute.

Stops motion 100 to 100,000 rpm.

Flash Duration: between 5 and 10 millionths of a second.

Power Source: any 115 volt, 60 cycle line.

Power Input: 25 watts. Size: 7 1/2 x 8 1/4 x 9.

Weight: 9 1/2 lbs. Price: \$140.00

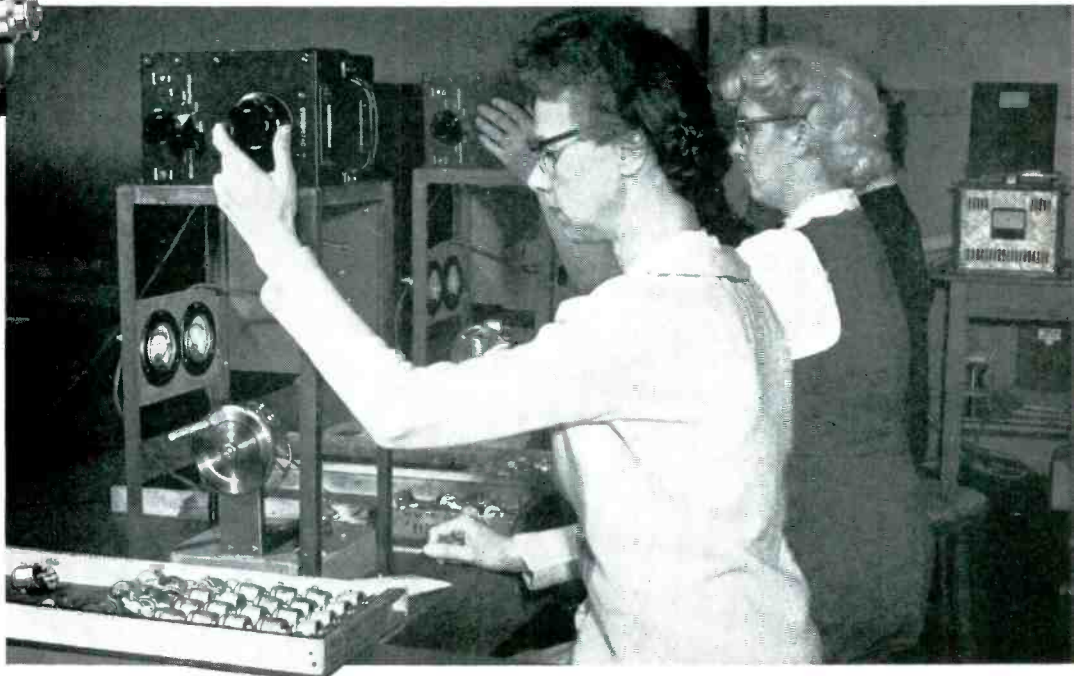

To Blake, as to thousands of other manufacturers of electrical and mechanical equipment, the STROBOTAC has made possible entirely new manufacturing, designing and testing techniques. We'd like to suggest some of STROBOTAC'S possibilities to you.

For Complete Information Write for EYES for INDUSTRY

GENERAL RADIO Company

275 Massachusetts Avenue, Cambridge 39, Mass.

90 West Street NEW YORK

920 S. Michigan Ave. CHICAGO

1000 N. Seward St. LOS ANGELES



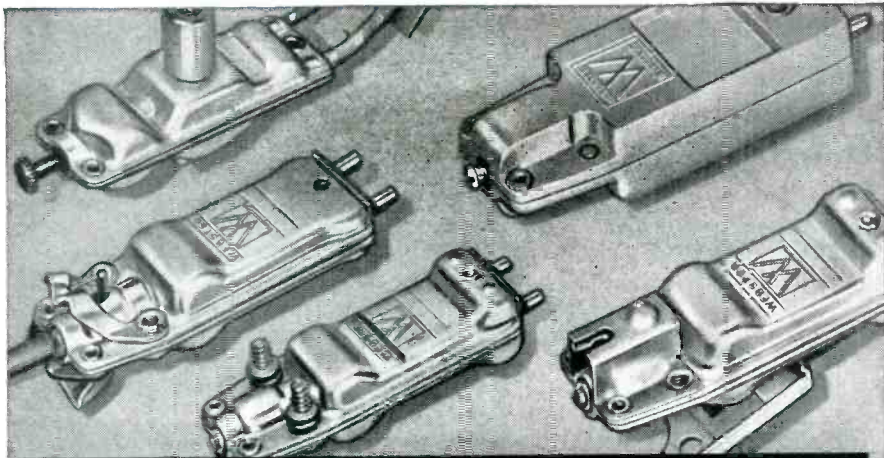

WEBSTER ELECTRIC one of the original
manufacturers of crystal cartridges

FOR OVER **20** YEARS
a complete line of cartridges

Engineered to meet your requirements

Webster Electric has been making cartridges for years and years... starting way back when cartridges were nearly as big as baseballs. The line of cartridges has constantly changed and improved to meet current requirements. Each year has brought improvements until cartridges are now available in thumb-nail size and versatile enough to meet the requirements of 78, 33 $\frac{1}{3}$ and 45 RPM.

Webster Electric has the experienced engineers, manufacturing know-how and long-range experience to make cartridges to meet all of the industry's requirements.

When you need a new cartridge submit your problem to Webster Electric. When your record players or changers are equipped with Webster Electric cartridges you can be assured of the best in dependable performance.

Webster Electric Company, Racine, Wis., Established 1907

out of service, switching six circuits from one transmitter to the other (antenna, program input, frequency monitor, modulation monitor, audio monitor and cathode-ray monitor) and applying plate voltage to the transmitter being placed in service.

Controls for most of these operations were grouped at one location. The exceptions were the frequency, modulation and cathode-ray monitors. They were fed from the same sampling antenna which excites the OA4G and therefore indicate operating conditions automatically for whichever transmitter is in use.

With a little practice, all remaining circuits can be switched in a fraction of a second. A completely automatic change-over could have been devised but it would have been considerably more complex and less reliable. Also, it would still require the minimum warm-up time of 12 seconds. The system described retains all of the advantages of human judgment with no added delay.

Pulse-Sharpening Circuit

IT IS OFTEN necessary to sharpen the output pulse of a detector in many applications. Sharpening of the pulse is usually done either to keep a fast discriminator or pulse-standardizing circuit from functioning improperly or to define the time of occurrence of an event more positively.

A pulse-sharpening circuit described by Leonard Reiffel on page 214 of *The Review of Scientific Instruments* for March 1951 was originally designed for use with a Geiger tube but may be adapted for other applications. Figure 1 shows this circuit.

The resonant circuit consisting of the parallel combination of L

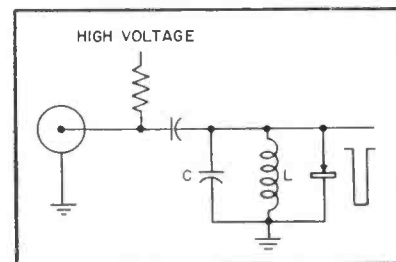
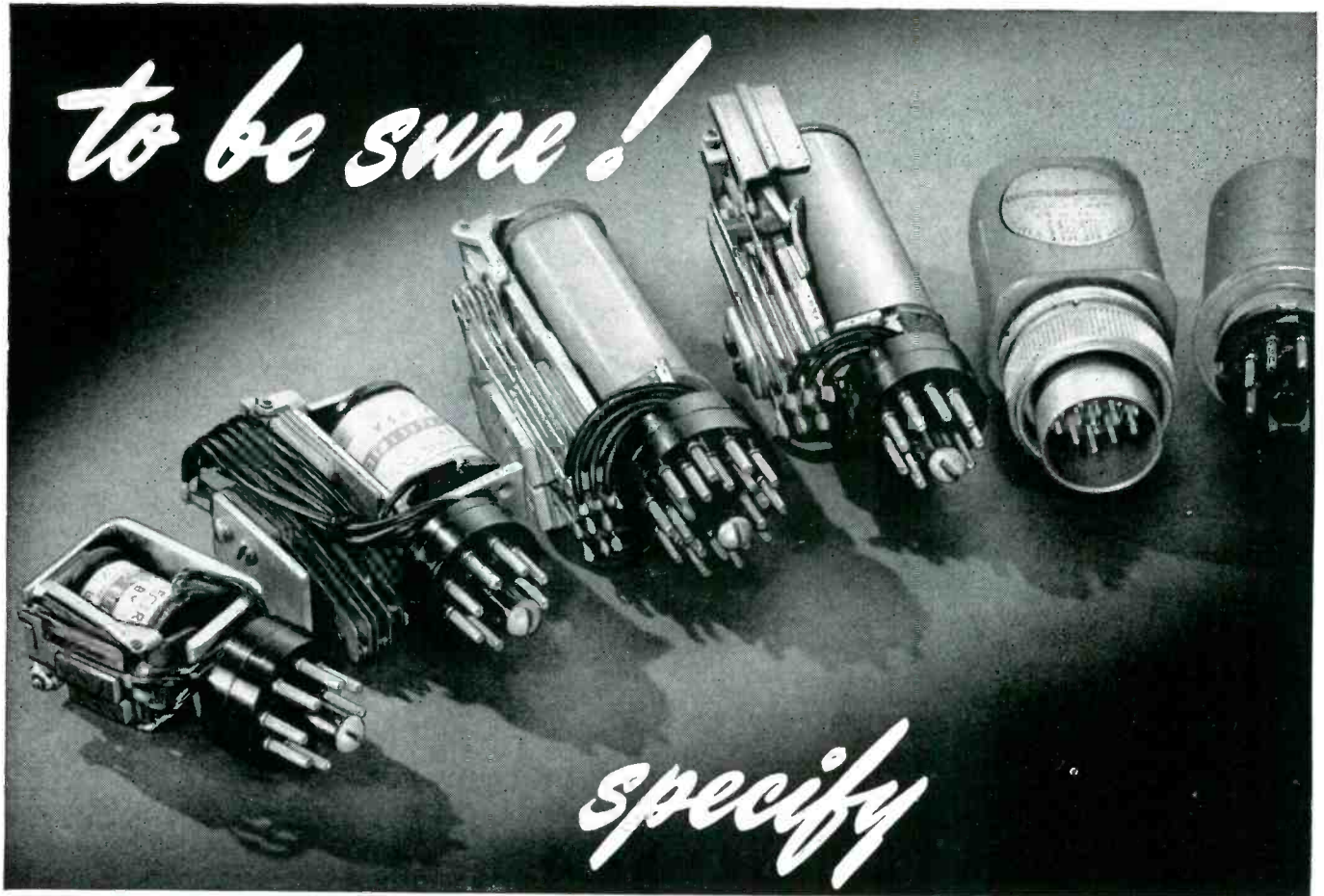

FIG. 1—Pulse-sharpening circuit

WEBSTER ELECTRIC
RACINE ♦ WISCONSIN

"Where Quality is a Responsibility and Fair Dealing an Obligation"



Automatic Electric "Plug-In" Relays

You specify "plug-in" relays to permit rapid replacement where continuous operation is vital. Be sure of the relays themselves, so *rapid* replacement doesn't become *frequent* replacement! Combine "plug-in" convenience with recognized quality in Automatic Electric relays.

COMPLETE LINE—typical assemblies are shown above. Notice that plugs are available with up to 20 pins, and for hermetically sealed relays if desired. Popular assemblies of Class "S", "Z", "B", "A", and "F" relays with "plug-ins" are available from stock. Others will be assembled to your order.

DEPENDABLE OPERATION—you can rely on the quality of all Automatic Electric relays—they're made to exacting telephone standards.

Be sure of your relays! Order "plug-in" relays (other types, too) from Automatic Electric's 88-page catalog. Write for your copy.

AUTOMATIC ELECTRIC SALES CORPORATION, 1033 West Van Buren Street, Chicago 7, Illinois. In Canada: Automatic Electric (Canada) Ltd., Toronto. Offices in principal cities.

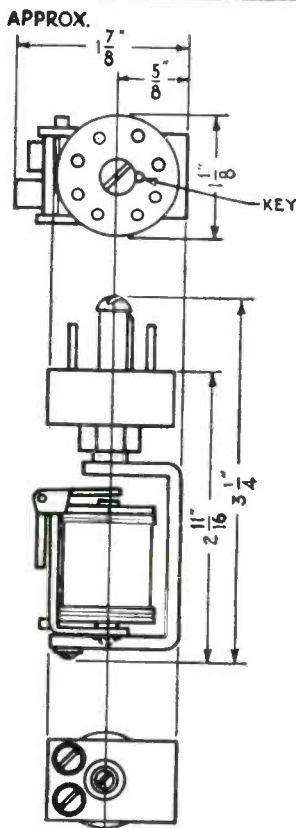

Dimensions of typical Class "S" relay with compact "plug-in" mounting.

RELAYS

SWITCHES

AUTOMATIC



ELECTRIC

CHICAGO

LOS GATOS BRAND TUBES

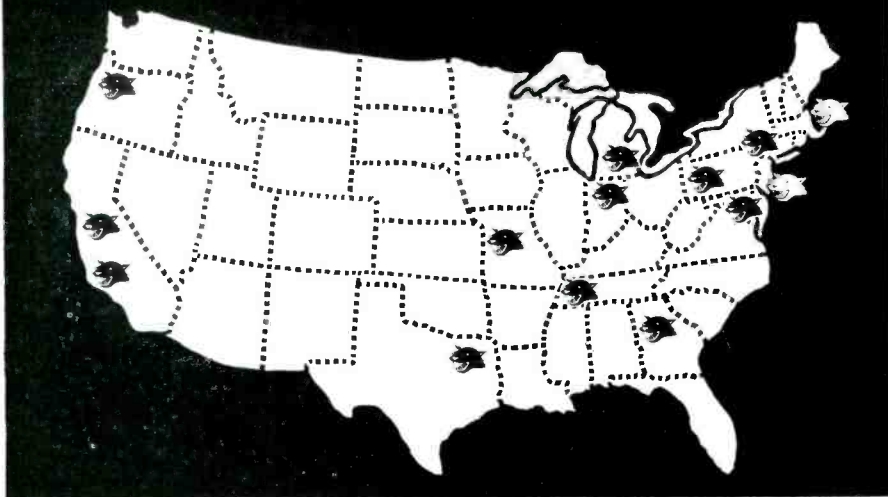

as near as your telephone

ATLANTA 5, GEORGIA

J. M. Cartwright & Son
1145 Peachtree Street N. E.
Phone: HEMlock 6161

BOSTON 9, MASSACHUSETTS

Harold A. Chamberlin
31 Milk Street
Phone: HUBbard 2-7022

DALLAS 1, TEXAS

J. Y. Schoonmaker Co.
2011 Cedar Springs
Phone: STerling 3335

DETROIT 24, MICHIGAN

Fred J. Stevens
15324 Mack Avenue
Phone: TUXedo 1-2277

FORT WAYNE 2, INDIANA

Southern Sales Co.
1135 Lincoln Tower
Phone: ANThony 5278

HADDONFIELD, NEW JERSEY

Ray T. Schottenberg
152 Merion Avenue
Phone: 9-6347

KANSAS CITY 8, MISSOURI

F. C. Somers & Co.
18th and Grand Avenue
Phone: JACkson 0791

LOS ANGELES 64, CALIFORNIA

W. Bert Knight Co.
10373 W. Pico Blvd.
Phone: BRAdshaw 2-5647

MEMPHIS 4, TENNESSEE

J. M. Cartwright & Son
1336 Madison Avenue
Phone: 2-1914

NEW YORK 7, NEW YORK

Perry Saffler Associates
53 Park Place
Phone: REctor 2-5334

PITTSBURGH 19, PENNSYLVANIA

Tanner & Covert
600 Grant Street
Phone: COurt 0131

PORTLAND 4, OREGON

Dale G. Weber
234 Sherlock Building
Phone: ATwater 5403

WASHINGTON 16, D. C.

J. Fred Whitehead
5403 Massachusetts Ave. N. W.
Phone: WISconsin 9176

Long-lived Los Gatos Brand tubes are setting new performance records in transmitting, rectifying, and industrial applications. Check with your Los Gatos representative.

LEWIS & KAUFMAN, INC.

LOS GATOS

CALIFORNIA



TUBES AT WORK

(continued)

and C is excited by the current pulse from the Geiger tube. When the resonant circuit is excited, a series of damped oscillations occur. The first half cycle of oscillation is negative and damping is comparatively slight during this period. When the second half cycle of oscillation begins and the polarity is reversed, the germanium diode begins to conduct and heavy damping is placed on the circuit. This damping may be large enough to dissipate all of the energy in the circuit during the first positive half cycle.

If the damping were heavy enough to dissipate the energy during the first half cycle, the output waveform would consist of one-half cycle of oscillation with negative polarity. The output pulse will be very short if the resonant frequency of the circuit is made high.

Constant-Amplitude Oscillator

BY NORRIS C. HEKIMIAN

*Radio Engineer
Central Radio Propagation Laboratory
National Bureau of Standards
Washington, D. C.*

FOR many applications it is desirable to have a source of r-f voltage which remains reasonably constant in spite of changes in tube parameters, supply voltage, heater voltage and load impedances. Adjustable-frequency oscillators should be stabilized against changes arising from variations in component parts and circuit reactances.

In the past, several systems have been devised to stabilize oscillators, including a modified avc system and fixed-level clipper circuits. The avc system is ineffective in stabilizing class-C oscillators because of the self-biasing feature of such oscillators.

The fixed-level clipper has a strong harmonic content in the output waveform. This effect can be reduced by adding a second resonant circuit after the clipper, resulting in increased output impedance and attendant circuit-tracking difficulties.

The oscillator to be described does not suffer from the foregoing

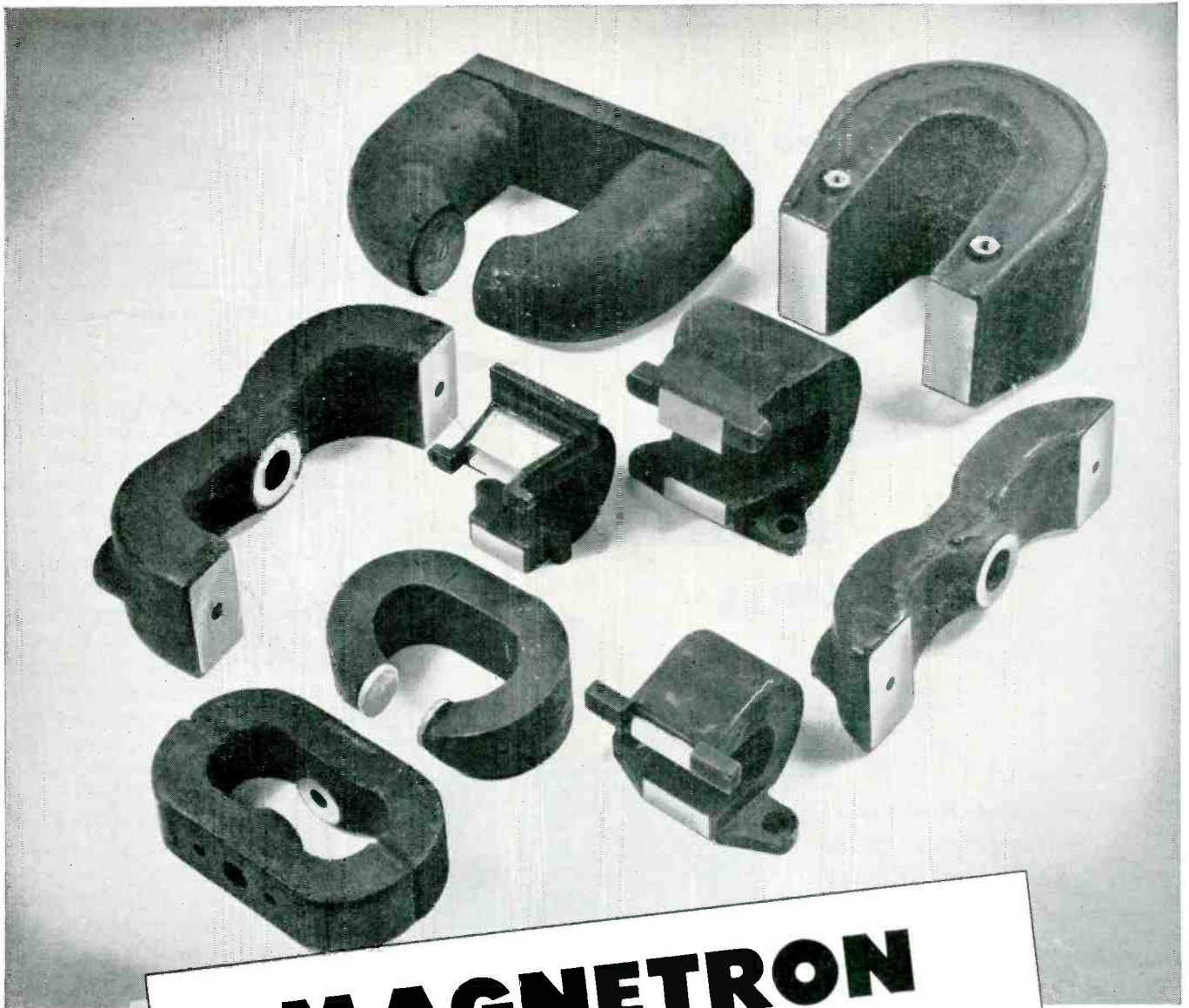

MAGNETRON PERMANENT MAGNETS AND ASSEMBLIES

with

- ☆ **Die Cast Aluminum Jackets**
- ☆ **Sand Cast Aluminum Jackets**
- ☆ **Celastic Covers**

Complete assemblies with Permendur, steel or aluminum bases, inserts and keepers as specified. Magnetized and stabilized as required.



THE ARNOLD ENGINEERING COMPANY

SUBSIDIARY OF ALLEGHENY LUDLUM STEEL CORPORATION

General Office & Plant: Marengo, Illinois

NEW LITTON TEST AND CONTROL EQUIPMENT SPEEDS, SIMPLIFIES HIGH POWER MICROWAVE WORK

New Litton U-Lines, Water Loads and Thermopiles are now available for faster, more efficient laboratory measurements in microwave problems. New Litton Electromagnets, Electromagnet Controllers and Filament Controllers are also offered to facilitate testing and control of magnetrons.

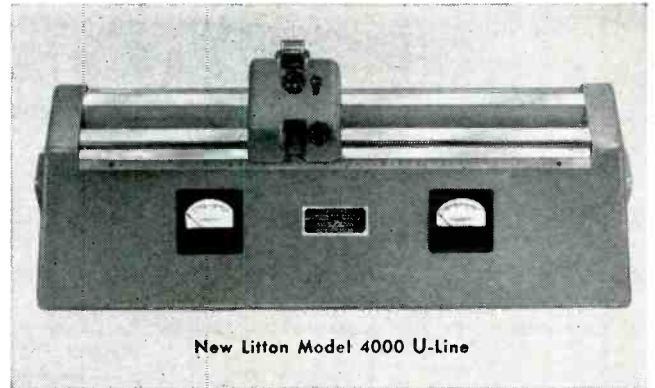

New Litton Model 4000 U-Line

LITTON U-LINE

New Model 4000 U-Line offers utmost convenience and accuracy in quickly determining VSWR in high-power coaxial lines. The equipment transduces power from a standard 1 5/8" coaxial line to a U-shaped configuration with round central conductor. Both central and outer conductors are mechanically rigid. A traveling probe moves on a precision carriage through the open end of the "U." The probe circuit includes assemblies from the Hewlett-Packard Model 805 Slotted Line. A millimeter scale with vernier indicates probe position. 50 centimeters of travel is available.

HIGH POWER RATING

Model 4000 offers continuous frequency coverage from 450 to 2,750 mc. with insertion VSWR of less than 1.05. Special Teflon bead supports make possible a conservative CW power rating of two kilowatts through the line. VSWR measurements may be made at any power level from kilowatts to microwatts. Standard equipment includes UG-50/U female couplings.

Auxiliary equipment available includes male couplings, VSWR meter, rf power output meter, and range switches to specification.



THERMOPILE

Model 3900 Thermopile is a sensitive, accurate indicator of small-differential temperatures. The unit is equipped with 30 pairs of copper-constantan junctions, and is tapped at 10 and 20 pairs. Uni-flare 1/4" fittings are provided for water connection. Recommended auxiliary meter has a 7-millivolt movement.

ELECTROMAGNET

Model 4807 Electromagnet is a low-voltage, high-current unit designed for general, across-the-line rectified service. It is shell-type in design, and will produce a field of 9,000 gauss across a 1/2" gap. Model 4807 is the standard Electromagnet recommended for use with Litton high-power CW magnetrons.

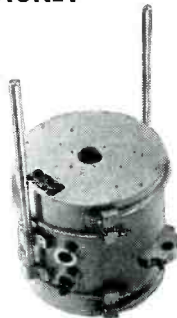

ELECTROMAGNET CONTROLLERS CATHODE SOCKETS

Litton Electromagnet Controllers and Cathode Sockets are available for use with Litton magnetrons.

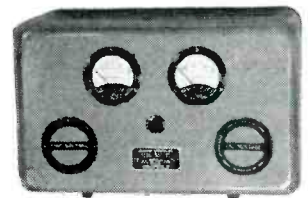

FILAMENT CONTROLLER

By regulating cathode temperature of Litton or other high-power magnetrons, Model 5001 Filament Controller can extend magnetron life as much as a factor of ten. The Controller holds cathode temperature constant over wide ranges of magnetron input power and load conditions. The Filament Controller operates on 115-v, 60-cps input and includes filament transformer.

WATER LOAD

As a termination for 1 5/8", 50-ohm coaxial lines, Litton Model 4100 Water Load is particularly useful in high-power applications where power output must be accurately measured. The Load is conservatively rated at 2 kilowatts capacity between 950 and 3,000 mc. VSWR is less than 1.2 over full range, and less than 1.1 above 2,000 mc.

For convenience in sampling rf power, the Water Load also includes two adjustable-depth probes.

For accurate power measurement Litton Model 3900 Thermopile and associated meter are recommended.

Many Litton CW and pulsed magnetrons are classified. With proper clearance established, we will gladly discuss our ability to fill your requirements.

Write for price and delivery information. Data subject to change without notice.

LITTON INDUSTRIES

SAN CARLOS, CALIFORNIA, U. S. A.

2301



DESIGNERS AND MANUFACTURERS of:
Glassworking Lathes and Accessories, Vertical Sealing Machines, Burner Equipment, Precision Spotwelders, Oil Vapor Vacuum Pumps, Glass Baking Ovens, Vacuum Tubes and Tube Components, Magnetrons, High Vacuum Molube Oil, Microwave Equipment.

... this
exclusive
two-way
feature

... plus
low cost



AVAILABLE ONLY IN SESSIONS SWITCH TIMERS

Automatic turn-off 1½ to 2 hours after set turn-on

This automatic shut-off feature, not available in competitive radio and television switch timers, provides lullaby switch with simplicity of operation and at low cost. Also, timer can be set to turn on radio or television set automatically for awakening or as a reminder. Other Sessions models available with separate, adjustable "Sleep-Slector" lullaby switch, and pleasing, slow-beat "Tru-Bel" alarm.

Sessions advanced designed move-

ments are famous for their split second accuracy and kitten-quiet operation. Dial, hands and bezel character styling to your specifications. Sessions versatile manufacturing facilities and capable design engineers are available for development and manufacture of special switch timers to meet your requirements. All movements guaranteed.

Write for new catalog. The Sessions Clock Company, Timer Div., Dept. 47, Forestville, Conn.

Sessions
SWITCH TIMERS



maintain E_k constant. In the test model of the constant-amplitude oscillator, E_k was obtained from batteries with internal resistances of about 5 ohms.

In Fig. 1, C_1 is a frequency-shifting trimmer and L_2 is a crystal-peaking coil employed when using a fifth overtone crystal (30 mc), the particular application for which the constant-amplitude oscillator was developed. Coil L_1 resonates at the crystal frequency with the circuit capacities shown.

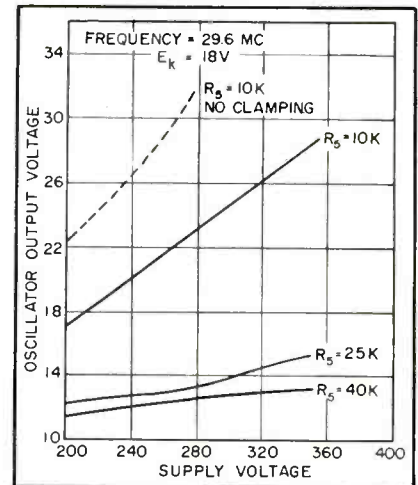

FIG. 2—Oscillator characteristic curves for different values of voltage-dropping resistance

Figures 2 and 3 illustrate the output amplitude stability obtained when the supply voltage, the bias voltage on V_a and plate-resistor R_s are varied. Constancy of amplitude versus supply voltage is easily measured and reflects to some extent the increased stabilization against tube parameter changes.

While it is possible to analyze graphically the constant-amplitude oscillator circuit, it is necessary to obtain at least one oscillator characteristic to do so. In most cases it may be advisable to determine circuit values roughly and then adjust the actual oscillator for optimum operation. In practice the output voltage is determined largely by the bias voltage E_k , as shown in Fig. 3, with R_s adjusted for satisfactory regulation. Care should be taken to allow for sufficient dissipation in R_s . A power-type resistor is generally necessary.

Improved clamping may be ob-

KENYON TRANSFORMERS

for standard
and special
applications

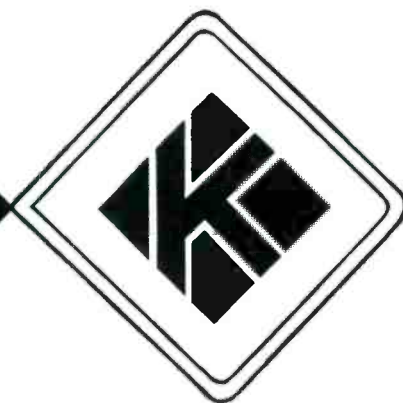

For more than 25 years, Kenyon has led the field in producing premium quality transformers. These rugged units are (1) engineered to specific requirements (2) manufactured for long, trouble-free operation (3) meet all Army-Navy specifications.

Kenyon Transformers for

- JAN APPLICATIONS
- RADAR
- BROADCAST
- ATOMIC ENERGY EQUIPMENT
- SPECIAL MACHINERY
- AUTOMATIC CONTROLS
- EXPERIMENTAL LABORATORIES

Write for details

KENYON TRANSFORMER CO., Inc.

840 Barry Street

New York 59, N. Y.



High Voltage Selenium Rectifiers

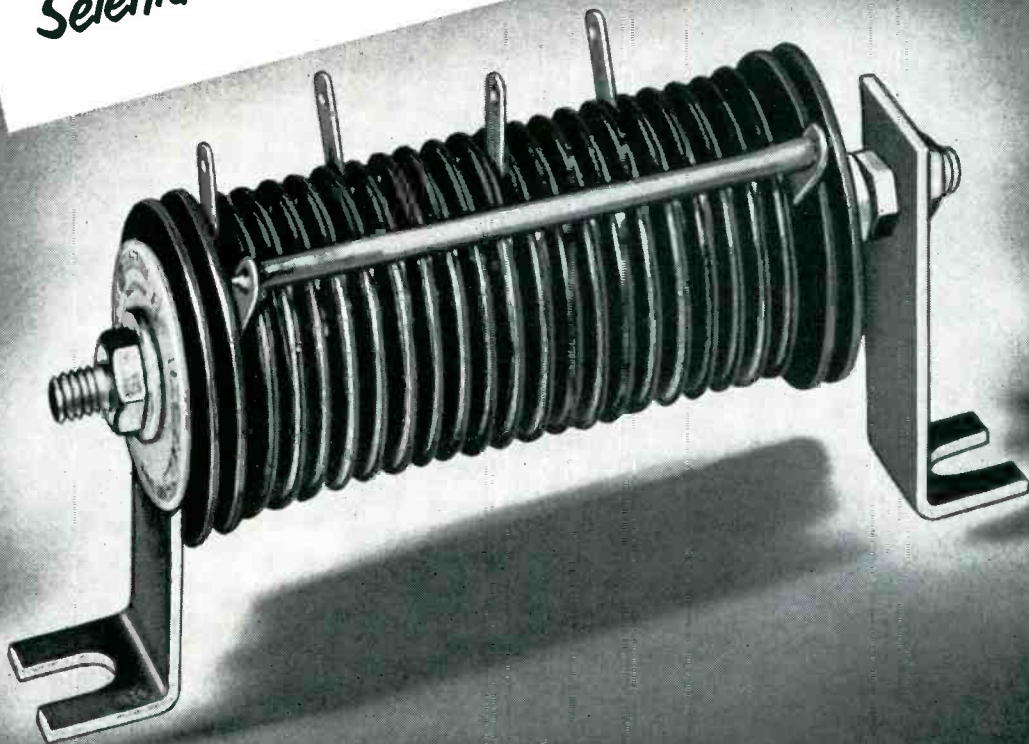

HOW TO TEST RECTIFIER QUALITY

Whether you buy selenium rectifiers for your own use or to build into your product, you want to know just what you are getting. We want you to compare G-E rectifiers with other rectifiers of the same rating. That way you can see for yourself the superior qualities of G-E selenium rectifiers before you buy.

Read these suggestions and then send for the testing bulletin.

COMPARE FORWARD RESISTANCE—Comparison will show the extremely low forward resistance of G-E cells—will show you why they deliver higher output voltage—will

show how you can cut costs in circuit components and design.

COMPARE BACK LEAKAGE—Comparison will show the low back leakage of G-E cells—will show you why their lower internal losses mean higher output. Lower leakages mean less heating, longer life, economical operation for G-E high-voltage rectifiers and the equipment they ably service.

COMPARE TEMPERATURE RISE—Because of their low forward resistance and low back leakage, they are cooler operating—don't overheat nearby parts—require less ventilation—have longer life.

We want you to make these comparison tests. We want you to prove to yourself conclusively that G-E selenium high-voltage rectifiers are superior. Compare, and you'll decide to use them in your next job—to make the long-term high output of G-E stacks help keep your product out front.

* * *

Write Section 461-15, *Apparatus Department, General Electric Company, Schenectady 5, New York* for a copy of GEA-5524 which gives details on comparative testing. Or, arrange for test details and sample units through the General Electric specialist at your local G-E office.

461-15

GENERAL  ELECTRIC

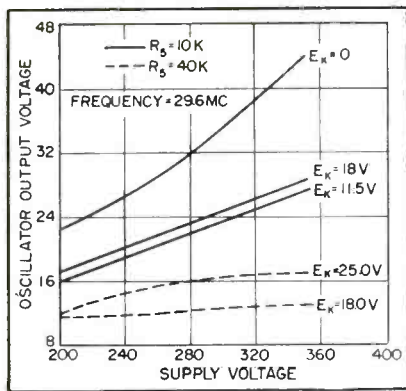

FIG. 2—Oscillator characteristic curves for different values of voltage-dropping resistance

tained by certain circuit modifications. By employing a voltage-multiplier type of rectifier to drive the clamper tube, a greater ratio of d-c control bias to r-f output voltage is obtained with resulting improved regulation. By using a power amplifier as a clamper instead of a type similar to the oscillator, the greater plate-current capabilities result in more positive control action.

If the clipper diode is fed from the final output of oscillator-buffer circuits with more gain included between the oscillator and the rectifier-control circuit, the sensitivity to small changes in output is increased and increased stability results.

Although the circuit described was designed for use as a fixed-frequency local oscillator in a gain-stable receiver, it is of value in other applications. Some suggested uses are in exciters, signal generators and high-quality communications receivers.

Home-Heating Control Modification

By E. M. HOWE

*Air Conditioning Engineer
McEldowney and Son, Inc.
Oklahoma City, Oklahoma*

IN THE SOUTHWESTERN portion of the United States, heating engineers are confronted with both summer and winter air-conditioning control problems. Practically all new buildings now under construction, or in contemplation, throughout this part of the country are to be cooled by refrigeration as well as heated.

There are times in the spring and

Only
\$1249*

Here's your
Answer
for

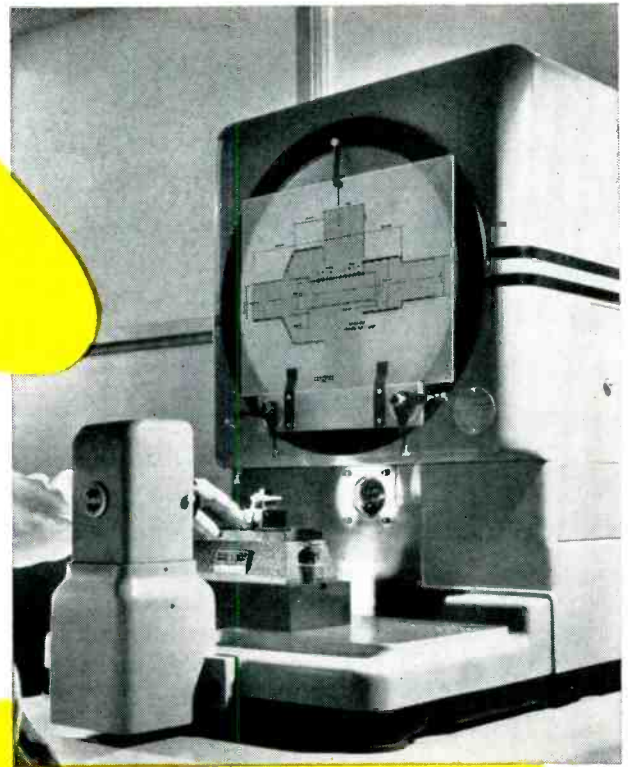

Low-Cost Production Inspection

This versatile, simplified version of the Kodak Contour Projector will fit into *your* inspection and assembly line. With it you can handle a wide variety of precision jobs, large or small.

Fast, accurate, and needing no cumbersome hoods or curtains, it takes little skill to operate. Gauging takes less time, is more complete. And experience has shown that fixtures for optical inspection outlast mechanical gauges by as much as ten to one.

If your work calls for examination of surface details and deep recesses, or requires vertical projection, there are accessories to do the job. Lenses are available for magnifications up to 100X. All optical parts are dust-sealed—never need adjustment.

We'll be glad to show you how this adaptable new instrument will work on your problems. Write to Eastman Kodak Company, Industrial Optical Sales Division, Rochester 4, N. Y.

the KODAK CONTOUR PROJECTOR, model 3

Distributed by ENGINEERS SPECIALTIES, Buffalo 9, N. Y.

*List price, F. O. B. Rochester, N. Y., magnification lenses and accessories extra. Price subject to change without notice.

Kodak
TRADE-MARK

Another BALLANTINE

achievement in
SENSITIVE ELECTRONIC VOLTMETERS

... THE MODEL 310A, a Super-Sensitive Electronic Voltmeter, measuring 100 microvolts to 100 volts from 10 cycles up to 1 MC with 3% accuracy (and up to 2 MC with 5% accuracy) at any point on the single logarithmic voltage scale.

- Input Impedance is 2 megohms shunted by 15 mmfds on the 0.001 and the 0.01 ranges and by 8 mmfds on the other ranges.
- Generous use of negative feedback provides customary Ballantine stability.
- Null Detector Switch enables instrument to be used as a null balance detector in bridge measurement work down to 20 microvolts.
- Six decade range switch permits entire voltage range to be read on a single voltage scale. Linear DB Scale.
- Illuminated and hand-calibrated meter scale.
- Amplifier section may be separately used as a 60, 40 or 20 DB pre-amplifier flat within ½ DB up to 2 MC.
- Available multipliers increase the voltage range to 1,000 or 10,000 volts.
- Available precision shunt resistors permit the measurement of AC currents from 1 ampere down to one-tenth of a microampere.

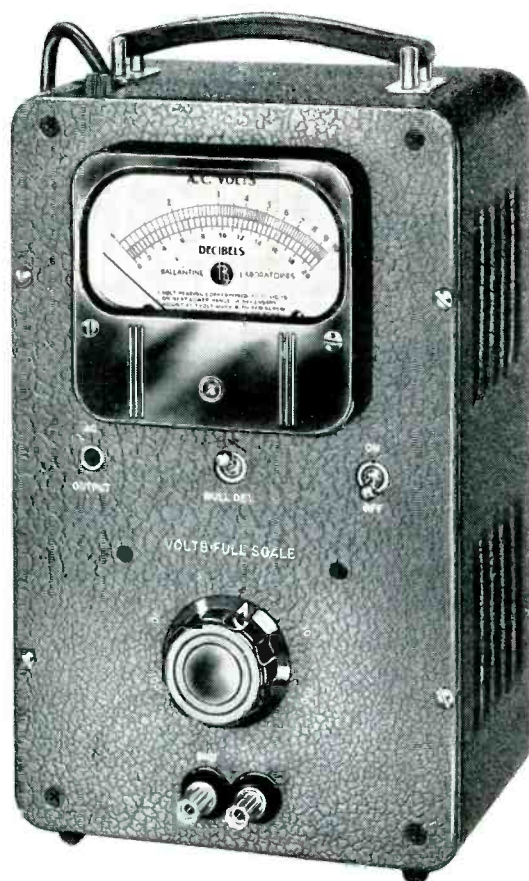

MODEL 310A

Price: \$235.

For further information on this Voltmeter and the Ballantine Model 300 Voltmeter, Battery Operated Voltmeters, Wide Band Voltmeters, Peak to Peak Voltmeters, Decade Amplifiers, Multipliers and Precision Shunt Resistors, write for catalog.

BALLANTINE LABORATORIES, INC.

100 FANNY ROAD, BOONTON, NEW JERSEY



fall when it is desirable to have a small amount of heat in the early morning and late evening with the cooling equipment operating during the day. This gives rise to the problem of a suitable control system which will provide just enough heating or cooling to balance the heat loss or gain of the structure, as well as one which can be easily shifted from the heating cycle to the cooling cycle.

A control system of this type must be inexpensive if it is to have a wide application in the field. It is reasonable for a contractor to spend five percent of the contract price on heating and cooling controls, but he could not be expected to spend 15 or 20 percent of the price on a good control system.

The use of electronic controls in the field of heating comfort gave results never before believed practical and this same control system applied to cooling was equally successful. However, the cost of most electronic control systems for year-round heating and cooling application was too large a percent of the contract price on the small business and residential applications for it to have a wide usage.

A modification of the Minneapolis-Honeywell R-7012A Relay for electronic control of home heating has been developed by the author. The modification is inexpensive and gives results closely approximating the ultimate goal for heating and cooling comfort. The original electronic system for heating was described in an article by J. M. Wilson in the December 1950 issue of

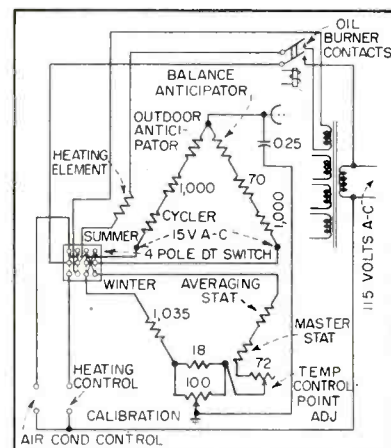
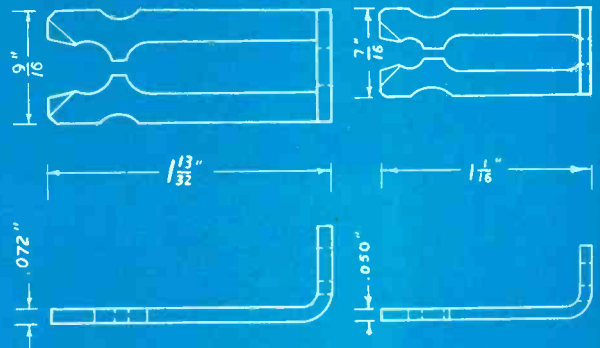
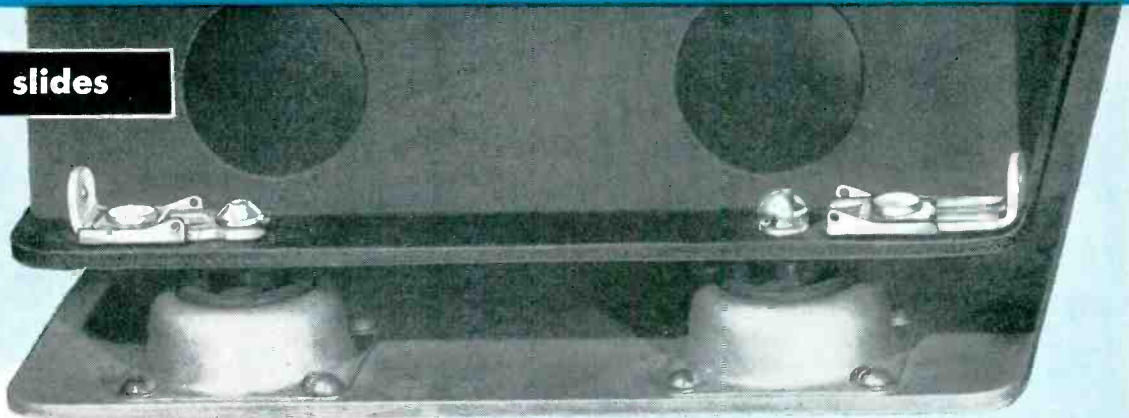

FIG. 1—Circuit modification to Minneapolis-Honeywell R7012A relay for summer-winter application

Hard Items to Find..

FOR ELECTRONIC OR AIRBORNE EQUIPMENT!

snap slides



For Electronic or Airborne Equipment!

SNAP SLIDES . . . Ready for fast delivery — these government approved snap slide fasteners provide a safe method of quickly attaching or removing chassis from mount. Securely locks by a simple push.

SPECIFICATIONS. In two sizes 1-13/32" x 9/16" .072 hard tempered stainless steel. 1-1/16" x 7/16" .050 hard tempered stainless steel. Set consists of 3 pieces as shown above. Studs are not ordinarily furnished but can be if desired.

identification buttons



Also fast delivery on these electronic identification buttons ready to mount to chassis. May be had in any color, combination of colors and numbered. In two size shanks 3/32" and 1/8" shank.



If your defense program requires additional metal working — Lorentzen is experienced in the production of all types of electronic chassis, cabinets, etc. Write for "IF" brochure describing our facilities.

H. K. Lorentzen, Inc., 391 West Broadway, N.Y. 12, N.Y.

I am interested in _____ quantity

Snap Slides . . . 1-13/32" . . . 1-1/16"

Identification Buttons

Please quote price and delivery Please send sample

Please send "IF" Facilities Catalog

COMPANY

ADDRESS

SIGNED

TITLE

H. K. LORENTZEN, INC. • 391 WEST BROADWAY • NEW YORK 12, NEW YORK

This is a

STANCOR

Custom Engineered Transformer!

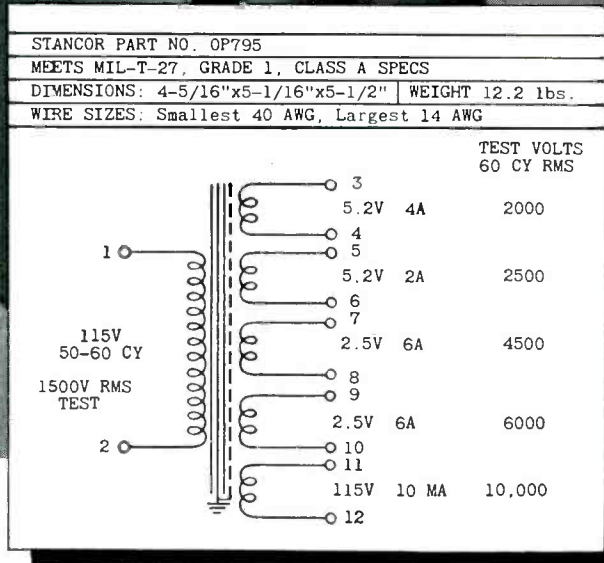
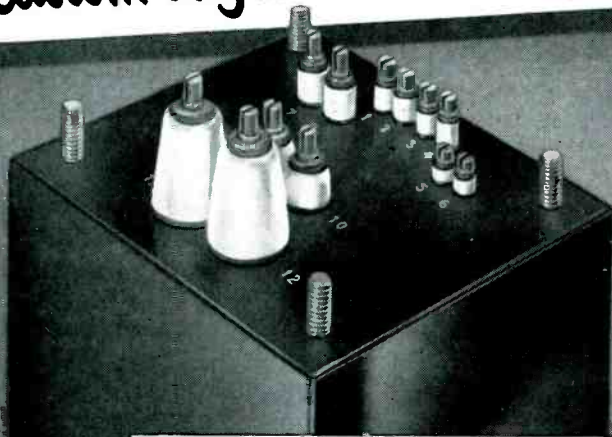

THIS isn't the simplest nor the most complicated transformer STANCOR has designed. It is a good example, however, of the kind of custom transformer design problem that STANCOR'S experienced engineers meet and solve every day as a matter of course. That's why we are confident that, whatever your special transformer problem may be, STANCOR engineers can and will solve them. Write today! Your inquiries will be promptly answered.



STANDARD TRANSFORMER CORPORATION

3578 ELSTON AVENUE, CHICAGO 18, ILLINOIS

ELECTRONICS, page 84. A schematic diagram of the modification is shown in Fig. 1.

Circuit Analysis

Basically, the circuit consists of a Wheatstone Bridge, an amplifier and a relay, with one leg of the bridge sensitive to temperature changes. The lower right-hand leg of the bridge has two resistors in series, a master thermostat and an averaging thermostat. It is intended that the two thermostats be located in different portions of the conditioned area to give an average temperature indication.

The thermostats themselves are temperature-sensitive resistors. When the temperature decreases, the resistors change in value and cause an unbalance in the bridge circuit. A signal voltage is then applied to the grid of the voltage amplifier. When this voltage indicates sufficient unbalance in the bridge, it will cause the relay to close an external circuit controlling the heating device.

As the bridge circuit approaches balance because of the increase of temperature in the controlled area, the voltage across the relay will decrease and the relay armature will drop out, breaking the external control circuit and stopping the furnace.

If the circuit position of the lower right-hand leg of the bridge were exchanged with that of the lower left-hand leg, the reaction previously described would occur in reverse. When the temperature decreased, the signal would decrease and cause the relay to open. Conversely, upon temperature rise a signal increasing in value would cause the relay to close.

Circuit Modification

To make this exchange in position of the legs of the bridge, a four-pole double-throw switch was inserted in the circuit as shown in Fig. 1. It is necessary to connect the relay to the cooling system when the switch is inserted and another pole of the switch is utilized for this purpose.

It was found undesirable to have the cyclor operate the relay during the cooling cycle as the recovery of

NEW Sperry Signal Source



operates
both low
and high
voltage
klystrons

A new *Microline* instrument, Model 555 Klystron Signal Source, is an extremely well-regulated power supply.

It features a continuously adjustable beam supply from 250 to 3600 volts. In addition, a reflector power supply is continuously variable from 0 to 1000 volts, and a control electrode supply is continuously variable from 0 to 300 volts. The versatility of this signal source permits operation of low voltage as well as high voltage klystrons.

Several types of modulation are provided with this instrument: sine wave at 60 cps, 0-300 volts peak to peak; saw tooth wave continuously variable from 600 to 1050 cps, 0-300 volts peak to peak with 15 microseconds decay time; and square wave continuously variable from 600 to 1050 cps, 0-300 volts peak to peak with 5 microseconds maximum rise and fall time. A modulation selector switch on the front panel permits external choice of type of modulation.

Write our Special Electronics Department for further information on Model 555 as well as other *Microline* instruments.

USABLE KLYSTRONS WITH MODEL 555 SIGNAL SOURCE

2K22	3K23	QK-277
2K25	3K27	QK-289
2K26	707B	QK-290
2K28	723A/B	QK-291
2K29	726A,B,C	QK-292
2K33	QK-140	QK-293
2K39	QK-141	QK-294
2K41	QK-142	QK-295
2K42	QK-143	QK-306
2K43	QK-159	6 BL6
2K44	QK-226	6 BM6
2K48	QK-227	SRX-16
2K56	QK-246	X-12
2K57	QK-269	X-13
		X-21



GYROSCOPE COMPANY

DIVISION OF THE SPERRY CORPORATION

GREAT NECK, NEW YORK • CLEVELAND • NEW ORLEANS • BROOKLYN • LOS ANGELES • SAN FRANCISCO • SEATTLE
IN CANADA — SPERRY GYROSCOPE COMPANY OF CANADA, LTD., INTERNATIONAL AVIATION BUILDING, MONTREAL

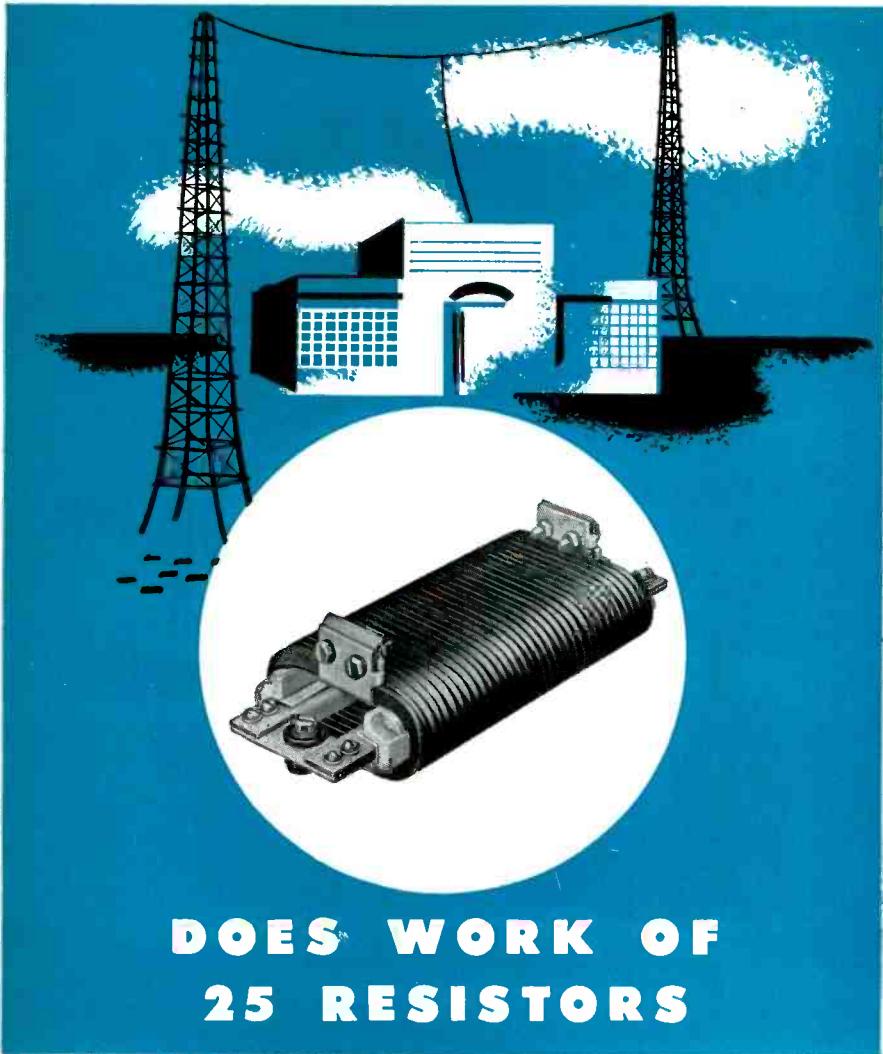

DOES WORK OF 25 RESISTORS

**saves work—and cost—
of hooking them up**

It used to take 25 conventional resistors, $1\frac{3}{4} \times 1\frac{1}{8}$ in., spaced on $2\frac{1}{2}$ in. centers, to keep the power company happy.

Ward Leonard worked out the problem with a *single* Edgeohm resistor, 19 in. long—saving all that space, weight, mounting and wiring.

Here's the application: a 40-kw radio transmitter, operating from a 50 kva transformer, made by a large transmitter manufacturer. Problem: limiting inrush current to avoid a severe voltage drop (objected to by the power company) and a strain on the line contactor.

This single Edgeohm unit is rated for continuous duty at 2200 watts, and when used for a 15-second interval, will dissipate 6400 watts!

Another example of Ward Leonard "Result Engineering", providing the desired result at a saving! WARD LEONARD ELECTRIC CO., 31 South Street, Mount Vernon, N. Y. Offices in principal cities of U. S. and Canada.

**WARD LEONARD
ELECTRIC COMPANY**

Result-Engineered Controls Since 1892

RESISTORS • RHEOSTATS • RELAYS • CONTROL DEVICES



the cooling system is not as fast as that of the heating system. In addition, the human body is not too susceptible to slight variations in temperature during the cooling cycle. To remove the operation of the cyler during cooling, only the circuit to the heater of the cyler was opened by the fourth contact of the switch.

The modified system described, fulfills all requirements in that the modification is inexpensive, it eliminates the usual assortment of heating and cooling thermostats and it makes only one installation necessary.

The system gives more accurate control during the cooling cycle than is possible to obtain with the usual line-voltage thermostat which has a wide differential, usually two to five degrees. The relay when modified retains the desirable characteristics of the electronic heating control during the heating season and when applied to cooling gives a simple one switch change-over.

Thermal Shunt for Soldering Resistors

SOLDERING of resistors in miniature and subminiature equipment is difficult because the resistors may easily become overheated and a permanent change in their values may result. One method developed to help overcome this difficulty is the use of a thermal shunt placed between the body of the resistor and the soldering lug during the soldering process.

A simple way of applying a thermal shunt is to use a pair of long-nose pliers, however, the pliers must not be removed for at least 15

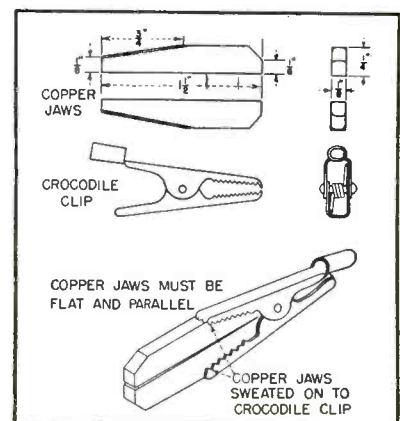
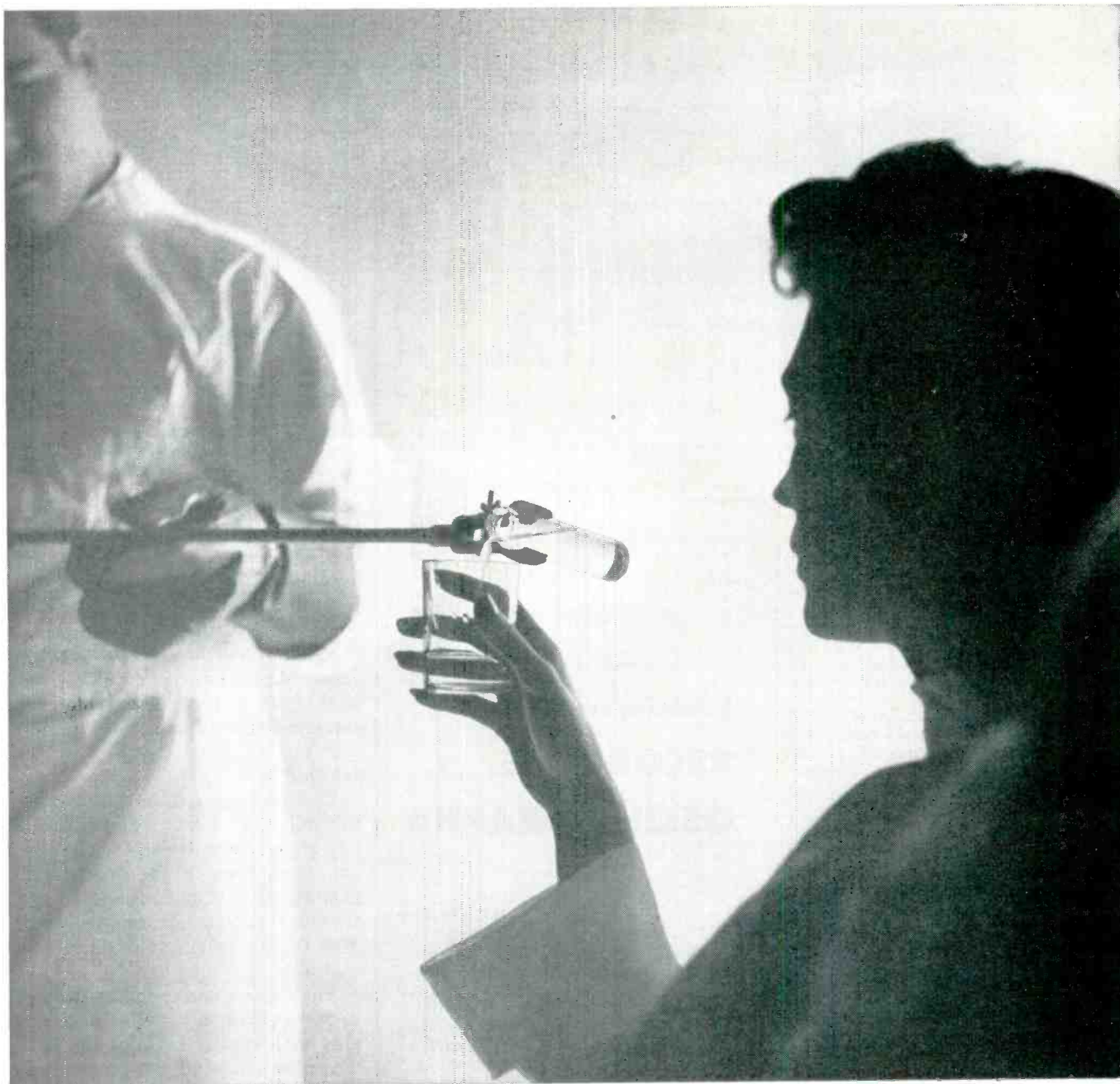

FIG. 1—Component parts and details of the clip-on thermal shunt



She's going to drink an atomic cocktail!

There's radioactive iodine in the odd "cocktail" this woman is about to drink.

Tomorrow, doctors will survey her with atomic instruments—and be able to tell if she has thyroid trouble!

Radioactive elements (called isotopes) are proving to be the greatest detectives in medicine. These "hot" atoms detect

thyroid trouble, cancer, tumors, even leukemia!

Hospitals all over the country are calling for isotopes. But the "hot" atoms don't stay hot for long. They must be delivered at top speed to be effective!

That's why, when shipping isotopes, drugs, and important chemicals, hospitals always prescribe the fastest possible method. They ask for Air Express!

Whatever your need or business, here are the unique advantages you can enjoy with regular use of Air Express:

IT'S FASTEST — Air Express gives the fastest, most complete door-to-door pick up and delivery service in all cities and principal towns, *at no extra cost.*

IT'S MORE CONVENIENT — One call to Air Express Division of the Railway Express Agency arranges everything.

IT'S DEPENDABLE — Air Express provides one-carrier responsibility all the way and gets a *receipt upon delivery.*

IT'S PROFITABLE — Air Express expands profit-making opportunities in distribution and merchandising.

For more facts call Air Express Division of Railway Express Agency.



 **AIR EXPRESS**
GETS THERE FIRST

clarity at
1/10,000
second

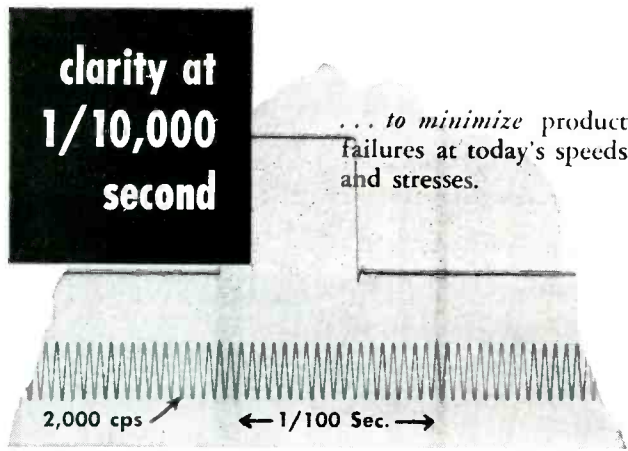

A PERMANENT RECORD is vital in present-day testing, for the millisecond and microsecond have become significant time periods, and interpretation of a phenomenon measured in these units must be accomplished after the phenomenon itself has passed. Consolidated Recording Oscillographs, with record speeds of 100 inches-per-second and higher, stretch the time coordinate to enable the test engineer to read with ease such events and to measure them precisely for evaluation. Consolidated Galvanometers, with *linear* frequency response up to 2000 cycles-per-second and more, are employed in the oscillographs to take full advantage of the high record speeds and to yield records on which 0.0002 second may be read with the unaided eye.

The portion of oscillograph record shown was travelling at 100 inches-per-second, each of the vertical timing lines representing 1/100th of a second "stopped" for leisurely, searching analy-

sis. The traces pictured are merely laboratory phenomena. They could as well be the high frequency vibrations and transient stresses which are so important a consideration in today's engineering designs. The test engineer's problem of isolating, measuring and interpreting these phenomena can be answered by Consolidated Recording Oscillographs and Galvanometers. Models are available to fit virtually every precision instrumentation program.

Consolidated RECORDING OSCILLOGRAPHS



CEC's 5-114 Recording Oscillograph, recording up to 18 traces simultaneously on 7"-wide paper or film, is designed as the ultimate in precision, versatility, and operating convenience and incorporates many features available only through special accessories on many other oscillographs. Recording speeds from 1/2" to 115" per second and easily removable feed-and-takeup record magazines of 125, 250, and 600-ft. capacity offer an unusually wide application range. Write for Bulletin CEC-1500-X26.



CEC's 5-116 Recording Oscillograph, costing considerably less than other instruments comparable in precision and versatility, produces records equal in quality to those of the 5-114 and lacks only those features which may be dispensed with in many recording applications. Recording up to either 9 or 14 traces, the 5-116 employs 5"-wide paper or film at recording speeds of 1/4" to 100" per second. Its removable feed-and-takeup magazine holds 125 feet of recording paper and is designed for the utmost loading and unloading convenience. Write for Bulletin CEC-1521-X9.

CONSOLIDATED ENGINEERING

Corporation

Analytical Instruments
300 No. Sierra Madre Villa



for Science and Industry
Pasadena 8, California

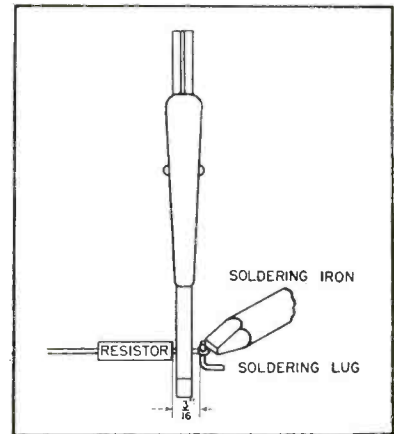

FIG. 2—Sketch showing how the shunt is used when soldering

seconds after the soldering joint has been completed. Copper pliers are more effective than steel ones because of the better conductivity but, in either case, the operator would tend to remove the pliers at the same time the soldering iron is removed. This practice allows the heat stored in the molten solder, the terminating lead and in the soldering lug to flow freely into the resistor body.

To guard against the operator removing the shunt too quickly, a clip-on device is desirable. The clip-on action compels the operator to remove the shunt forcibly and thereby tends to prevent the operator from removing the shunt prematurely.

The clip-on device finally decided upon utilizes a simple crocodile clip with copper bars in its jaws. The dimensions of the copper bars are 1/8-in. thick, 1/4-in. wide and 1 1/2-in. long. The component parts and details of the clip-on thermal shunt are shown in Fig. 1. Figure 2 shows a sketch of the shunt in use.

The information in this article was abstracted from a report by E. N. Shaw entitled "The Overheating of Miniature Resistors During Soldering" published by the Telecommunications Research Establishment of Worcester, England.

Position Indicator

A RECENT DEVELOPMENT in the field of position indication consists of a magnetic measuring system coupled to an electronic circuit for control or remote indication purposes. The instrument is espe-

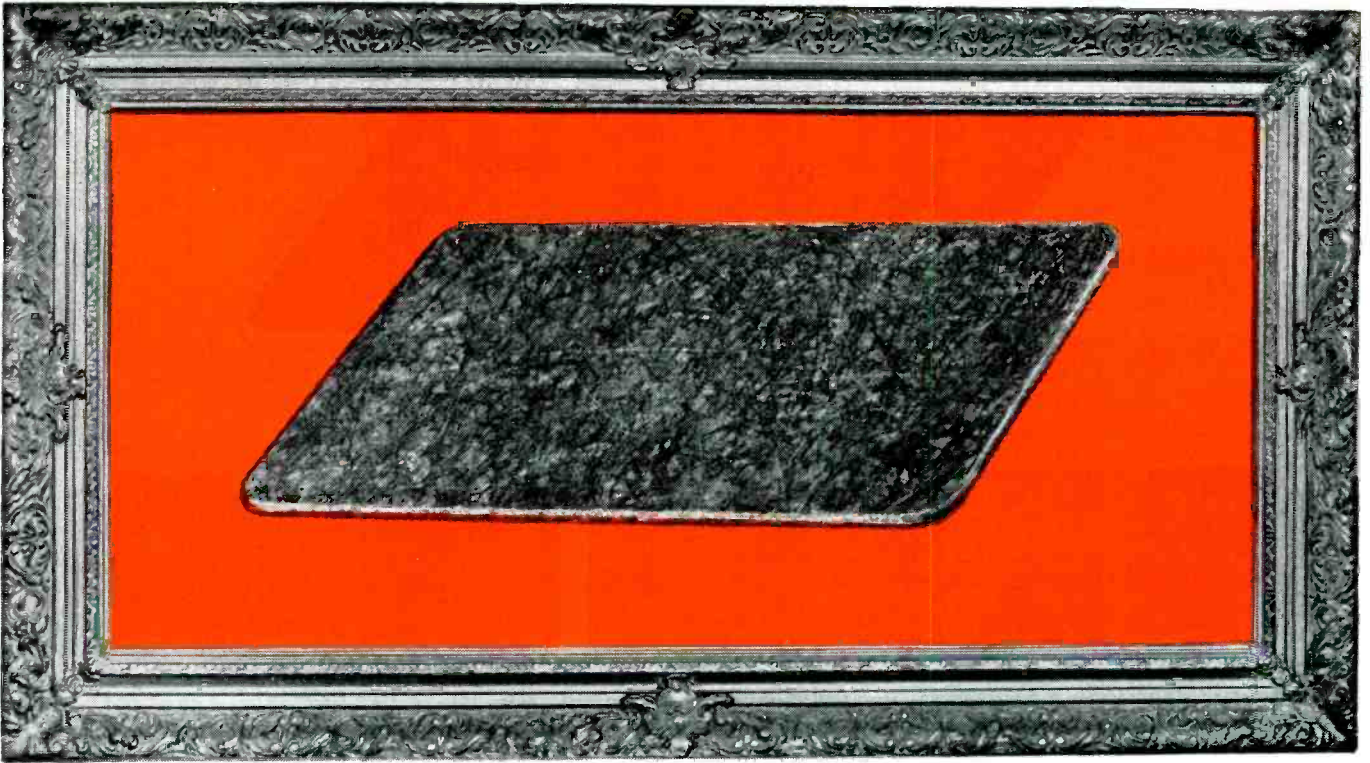

PORTRAIT OF A 50% SAVING !

This is a picture of a laminate reinforced with Fiberglas* mat.

It matches—even surpasses—the electrical and mechanical properties of laminates reinforced with organic materials . . . *yet it costs as much as 50% less!*

Because the Fiberglas materials used for reinforcement in this new laminate panel resist the destructive action of water, oils, and most chemicals, the laminate is ideal for insulating apparatus which is subject to extreme operating conditions. Electrical properties of this glass-reinforced material are superior. Arc resistance has an ASTM rating of 150 sec. It machines readily and cleanly in production op-

erations where carbide tipped cutting tools are used.

If you make or use electrical apparatus, and want top-flight insulation at rock-bottom cost, consider laminates reinforced with Fiberglas mat.

Sheet stock and molded shapes made of Fiberglas glass-base laminates give superior service for—

**COIL WASHERS • TERMINAL BLOCKS
BARRIERS and SHIELDS • SLOT WEDGES
END LAMINATIONS • BASE PLATES
LAYER INSULATION**



IS IN YOUR LIFE...FOR GOOD!

*Fiberglas is the trade-mark (Reg. U. S. Pat. Off.) of Owens-Corning Fiberglas Corporation for a variety of products made of or with glass fibers.

OWENS-CORNING FIBERGLAS CORPORATION
Electrical Sales Division, Dept. 860
16 E. 56th Street, New York 22, N. Y.

Please give me more information about Fiberglas glass-base laminates.

NAME.....
TITLE.....
COMPANY.....
STREET.....
CITY..... ZONE..... STATE.....

U. S. NAVAL AIR DEVELOPMENT CENTER
JOHNSVILLE, PA.

takes its
ENVIRONMENTAL TEST PROBLEMS

to **Tenney**

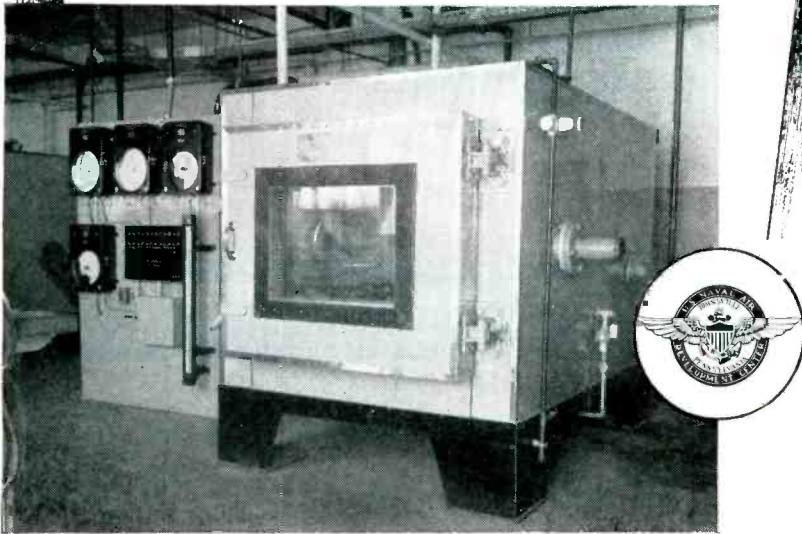

Maximum flexibility, efficiency, dependability—those are essentials of test-chamber design for military research use. And those are the qualities engineered into the Tenney Test Chamber recently installed at the U. S. Naval Air Development Center, Johnsville, Pa., for environmental testing of aircraft components.

Specifications: Altitude to 80,000 feet; humidity, 20% to 95%; temperature, -100° F. to $+200^{\circ}$ F.; any temperature—altitude conditions simultaneously; automatic program cycling control with minimum elapsed time for obtaining all extreme conditions.

For all types of testing—development, research, specification, and production—a Tenney-engineered chamber will meet your requirements. For testing under all degrees of humidity, at all altitudes and temperatures, a Tenney-built test chamber assures complete dependability and precisely controlled test data. Automatic cycling, indicating, and/or recording systems to your specifications, if desired.

For further information without obligation, write Tenney Engineering, Inc., Dept. J, 26 Avenue B, Newark 5, New Jersey.

Test Chamber Design for Every Industrial Use



Ⓜ 8034

Manufacturers of Automatic Temperature, Humidity, and Pressure Control Equipment

cially suited for the indication of liquid levels particularly under high pressures and where seals would be undesirable.

The principle of operation used is that of a cylindrical float with a bar magnet mounted on its axis so that as the float rises or falls, the magnet rolls in vertical guides. A vertical strip magnet is located outside the float chamber. This magnet is magnetized in such a way that the poles lie along the vertical sides of the strip.

The magnetized strip is pivoted horizontally at a point in its length which corresponds to the normal level of liquid in the chamber with a suitable adjustment for height. The strip is mounted so that its magnetic poles and those on the floating magnet repel each other. The floating cylinder therefore rolls against the guides without friction. When the cylinder leaves its normal position, it tends to repel the strip magnet and cause it to rotate slightly one way or the other and close a pair of contacts fixed to it.

The contacts are connected to the grid circuit of an amplifying tube whose output may be used to operate automatic control equipment to change the liquid level or operate remote indication devices.

A restoring force for the strip magnet and contact arm is provided by electromagnetic or pneumatic means.

Measuring Muzzle Velocity

CONVENTIONAL equipment used for testing muzzle velocities of large-calibre pistols utilize magnetic pickups. Such equipment is not applicable for determining the muzzle velocity of pistols firing pellets of the order of 0.177 calibre.

The problem of determining the muzzle velocities of air pistols firing small-calibre lead pellets may be solved by the arrangement shown in Fig. 1. Each photocell is located opposite a narrow-beam light source. The air pistol is mounted in a cradle and aimed so that the pellet passes between the photocells and the light sources.

When the pellet passes between

NEW!

THIN ELECTRICAL STEELS FOR OPERATION

at 400 Cycles

Two new thin (4-mil) oriented electrical steels for operation at 400 cycles have been developed by Armco Research. They are known as Armco TRAN-COR T-O and TRAN-COR T-O-S.

TRAN-COR T-O was developed for use at 400 cps and higher with inductions up to 16 kilogausses. TRAN-COR T-O-S is recommended for equipment where more perfect orientation permits operations at still higher induction without excessive excitation.

The new TRAN-COR T-O-S can be operated at inductions 20% higher than any nickel-iron alloy. It was developed under a contract with the Bureau of Aeronautics of the Navy Department to make possible a great reduction in weight of airborne electrical equipment.

Curves on this page show a comparison of the excitation required by the two grades of oriented 4-mil material. TRAN-COR T-O-S is so carefully controlled in processing that the minimum permeability at 18 kilogausses is 1800. This value is not usually attained even at 14 kilogausses by the best grades of non-oriented high silicon steel.

TRAN-COR T-O-S has a density of 7.65, a volume resistivity of 47 microhm cm. or 282 ohms/mil ft., and a lamination factor of 95% solid.

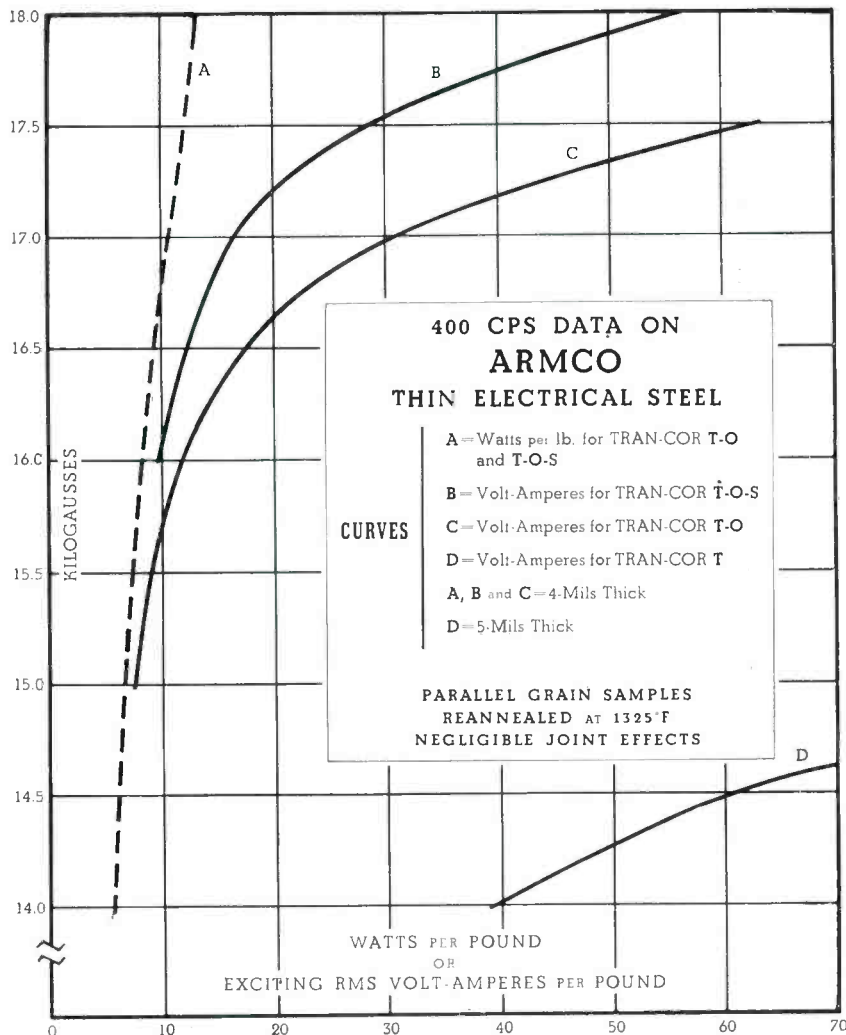

More Scrap Means More Steel!

Without more steel scrap, maximum steel production is impossible. New furnaces built by the industry cannot be operated at capacity with the present scrap supply. Help us help you. Sell your scrap... today.

ARMCO STEEL CORPORATION

3551 Curtis Street, Middletown, Ohio • Plants and Sales Offices from Coast to Coast • Export: The Armco International Corporation





2500 Type
"Lock-on" Relay



M Type "Midget"
In Sealed Cap

NORTH RELAYS

FOR MULTIPLE REMOTE CONTROL

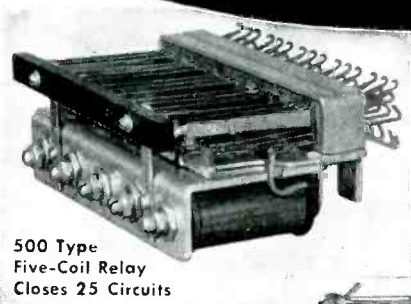

500 Type
Five-Coil Relay
Closes 25 Circuits

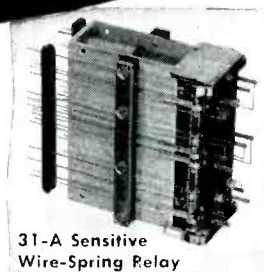

31-A Sensitive
Wire-Spring Relay

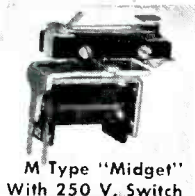

M Type "Midget"
With 250 V. Switch



2600 Type
"Slow-Release" Relay

IT would be misleading to pick a single remote control function and describe it as typical of North Relays. Actually the range of application covers everything in the field of high-speed sensitive relays. If you wish to remote-control multiple circuits, there's a North Relay to make and/or break up to 32 of them with one impulse, controlled by a single-pair at low voltage. If you require extra sensitivity and speed in compact form, see the North M Type "Midget", designed to operate on less power than ordinary midgets (.05 Watt at normal spring load) yet occupy less than 2¼ cubic inches. There are more than 100 combinations of multiple make or break contacts available in either the Midget or heavy-coil relays. To get some idea of the variety in between . . .

. . . ASK FOR THE NEW
INFORMATIVE NORTH RELAY CATALOG



THE NORTH ELECTRIC MANUFACTURING COMPANY

1438T South Market Street, Galion, Ohio.

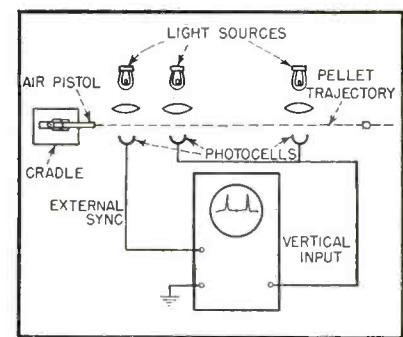

FIG. 1—Sketch of the arrangement for measuring the muzzle velocity of air pistols

the first photocell and light source, interrupting the beam of light, the low-speed driven sweep of the oscilloscope is initiated. As the pellet passes between the second and third beams, the electrical impulses generated are applied to the vertical deflection plates of the oscilloscope. These impulses appear on the screen as vertical deflections.

The muzzle velocity can be computed by measuring the distance between the two vertical deflections. For continual use in a production setup, the limits representing maximum and minimum tolerable muzzle velocity may be marked on the screen. By so doing, testing can be done by wholly unskilled workers.

This material was abstracted from the 1950 July-September issue of *The Oscillographer*, published by the Allen B. DuMont Laboratories, Inc.

Robot Control for TV Transmitter

AN EXPERIMENTAL robot control for the new BBC tv transmitter at Daventry, England, has been incorporated in the control room. The robot rings an alarm bell if anything goes wrong with the transmitter and engineers in the transmitting building several hundred yards away or in London can switch over transmitters by means of a system of telephone signals.

A giant fan and air-cooled valves are used in the new transmitter. The fan brings in fresh air and uses the heated air, if necessary, to circulate through the station for heating purposes.

Typical of the TOUGH POTENTIOMETER JOBS solved by Helipot

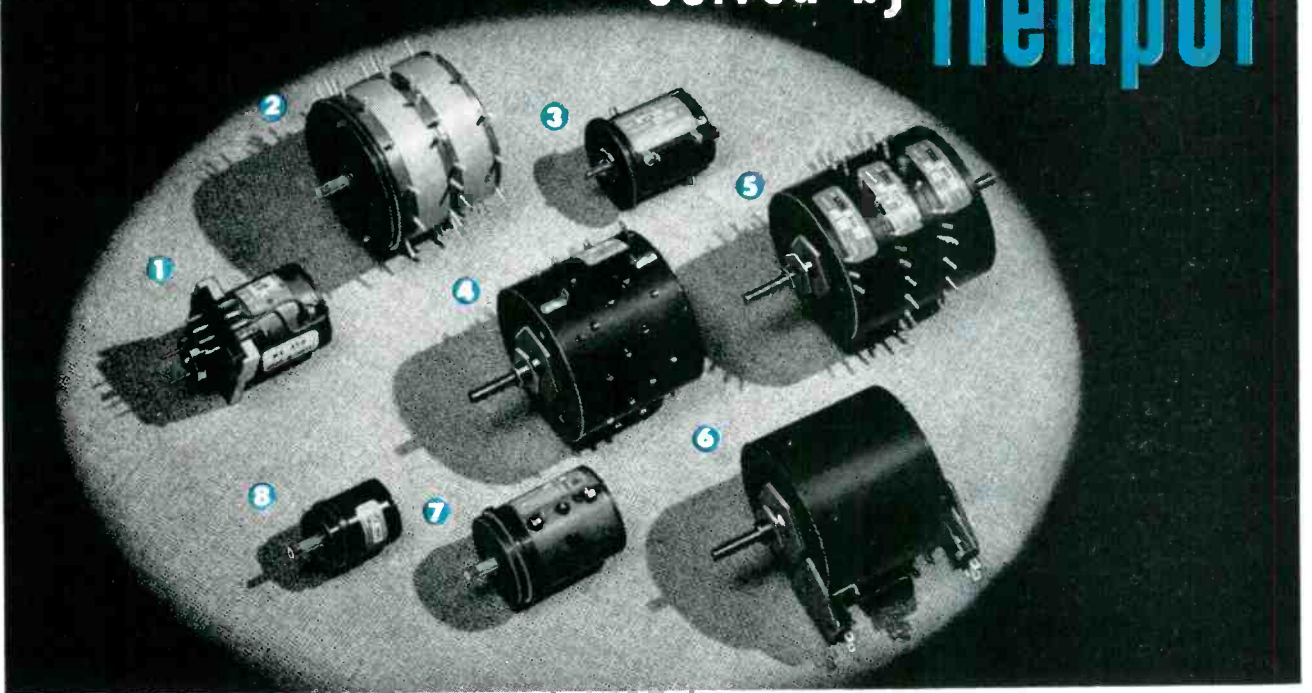

Precise Accuracy + Maximum Versatility + Space-saving Compactness

The potentiometers illustrated above are typical examples of the tough problems HELIPOT engineers are solving every day for modern electronic applications. If you have a problem calling for utmost precision in the design, construction and operation of potentiometer units—coupled with minimum space requirements and maximum adaptability to installation and operating limitations—bring your problems to HELIPOT. Here you will find advanced "know-how," coupled with manufacturing facilities unequaled in the industry!

The HELIPOTS above—now in production for various military and industrial applications—include the following unique features...

① This 10-turn HELIPOT combines highest electrical accuracies with extremes in mechanical precision. It features zero electrical and mechanical backlash... a precision-supported shaft running on ball bearings at each end of the housing for low torque and long life ... materials selected for greatest possible stability under aging and temperature extremes ... special mounting and coupling for "plug-in" convenience ... mechanical and electrical rotation held to a tolerance of $\frac{1}{2}^\circ$... resistance and linearity accuracies, $\pm 1\%$ and $\pm 0.025\%$, or better, respectively.

② This four-gang assembly of Model F single-turn potentiometers has a special machined aluminum front end for servo-type panel mounting, with shaft supported by precision ball bearings and having a splined and threaded front extension. Each of the four resistance elements contains 10 equi-spaced tap connections with terminals, and all parts are machined for greatest possible stability and accuracy.

③ This standard Model A, 10-turn HELIPOT has been modified to incorporate ball bearings on the shaft and a special flange (or

ring-type) mounting surface in place of the customary threaded bushing. This HELIPOT also contains additional taps and terminals at the $\frac{1}{4}$ - and $9\frac{3}{4}$ -turn positions.

④ This standard Model B, 15-turn HELIPOT has a total of 40 special tap connections which are located in accordance with a schedule of positions required by the user to permit external resistance padding which changes the normally-linear resistance vs. rotation curve to one having predetermined non-linear characteristics. All taps are permanently spot-welded and short out only one or two turns on the resistance element—a unique HELIPOT feature!

⑤ This six-gang assembly of standard Model F single-turn potentiometers has the customary threaded bushing mountings, and has shaft extensions at each end. The two center potentiometers each have 19 equi-spaced, spot-welded tap connections brought out to terminals. Each tap shorts only two turns of .009" diameter wire on the resistance element.

⑥ This Model B, 15-turn HELIPOT has been modified to incorporate, at the extreme

ends of mechanical and electrical rotation, switches which control circuits entirely separate from the HELIPOT coil or its slider contact.

⑦ This 10-turn HELIPOT has many design features similar to those described for unit No. 1, plus the following additional features ... a servo-type front end mounting ... splined and threaded shaft extension ... and a center tap on the coil. All components are machined to the highest accuracy, with concentricities and alignments held in some places to a few *ten-thousandths* of an inch to conform to the precision of the mechanical systems in which this HELIPOT is used. Linearity accuracies frequently run as high as $\pm 0.010\%$!

⑧ This single-turn Model G Potentiometer has been modified to incorporate a ball bearing shaft and a servo-type front end mounting. Special attention is given to contact designs and pressures to insure that starting torque does not exceed 0.2 inch-ounces under all conditions of temperature.

The above precision potentiometers are only typical of the hundreds of specialized designs which have been developed and produced by HELIPOT to meet rigid customer specifications. For the utmost in accuracy, dependability and adaptability, bring your potentiometer problems to HELIPOT!

Representatives in all major areas of the United States. Export agents: Frathom Co., 55 W. 42nd St., New York 18.

THE Helipot CORPORATION, SOUTH PASADENA 2, CALIFORNIA

Here's why those in the know

—demand

CANNON PLUGS

Here's another example of the meticulous care Cannon Electric uses in building connectors for highly specialized, tough jobs. This AN-"M" type connector is moisture-proof, vibration-proof and pressurized. Radio shielding is provided and every threaded part is drilled for safety wiring.

No corners are cut—nothing is overlooked to assure you outstanding performance. This connector is designed for aircraft use but there are more than 18,000 different Cannon Plugs made with the same care to serve the exacting needs of many industries. If you are looking for real value, regardless of the field you work in, your best bet is Cannon.

Engineering bulletins describing each of the many basic types of connectors are available. We will gladly send you any of these if you will simply describe your connector requirements.

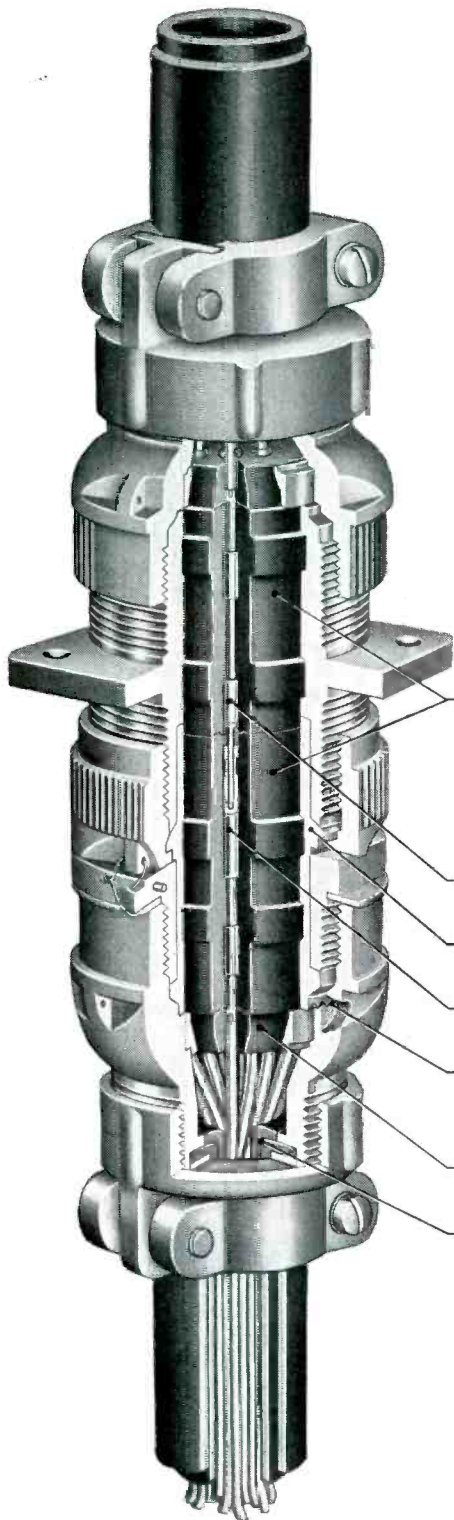

Molded Polychloreprene inserts 75-80 shore hardness provide pressure-proofing of both pin and socket contacts. Have high dielectric strength under wide range of temperatures and at extreme altitudes. Mated fittings will not show more than 10 microamperes dielectric leakage and will not arc when subjected to 7500V dc at room temperature.

Pin Contacts machined from solid brass, silver-plated. Solder cup hand-tinned.

Machined ball-in-cone joints provide radio shielding and improve vibration resistance.

Socket contacts machined from solid copper alloy with new Cannon design, silver-plated.

Matching serrations in end bell and shell make practical wrench-tightening from one side of the installation without putting strain on contacts or wires.

Polychloreprene grommets make moisture-proof seal over soldered connections.

Concentric rubber bushings under pressure of cable clamp provide snug, moisture-proof wire entry. Eliminate usual strain on outer wires. Provision is made for grounding lug.



CANNON ELECTRIC

Since 1915

Cannon Electric Company
Los Angeles 31, California

Factories in Los Angeles, Toronto, New Haven. Representation in principal cities.

THE ELECTRON ART

(continued from p 140)

num film and excite the phosphor.

In general, excitation occurs only over a short portion of alternate half-cycles. It occurs on the negative swings, because the penetrating power of the electrons is greater than that of the positive ions. At radio frequencies the number of exciting pulses per second is sufficiently large to produce, as far as the eye can detect, a uniformly illuminated screen. The frequency of the exciting pulses is not critical; in apparatus devised by the author, it is of the order of one megacycle. The r-f voltage must exceed 5,000 volts.

Although the electron and ion current during excitation of the screen is of the order of a milliampere, the displacement current may be 100 times as large. It is important, therefore, that care be exercised to minimize stray capacitance between the probe and ground, especially if several tubes are to be operated simultaneously from the same oscillator.

Small bulbs or enclosures containing a phosphor screen may be successfully examined simply by plugging the stem with a rubber stopper containing two holes, one in the center for a metal probe, the other for a piece of glass exhaust tubing. After the pressure range

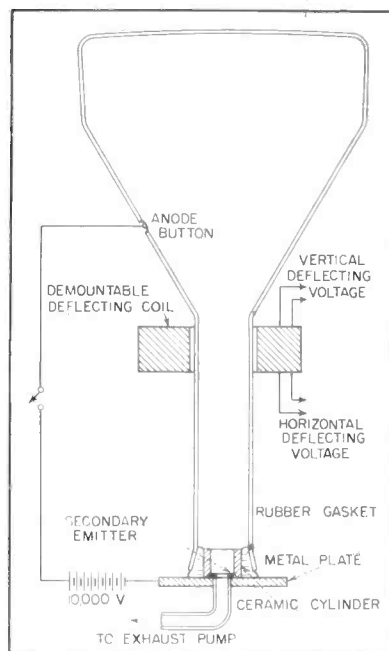

FIG. 2—Schematic of d-c method for testing picture tube screens

40,000,000 watts in a single envelope

...with the help of LOW CARBON NICKEL

Specifications for the Armed Services' VC-1257, a large hydrogen thyratron tube, call for an output of 40 megawatts. This requires tube operation at 40,000 volts, at a peak current of 2000 amperes.

When approached with the problem, engineers at Chatham Electronics Corp., Newark 2, N. J., knew that the metal parts of the tube should have the following qualities:

1. A low carbon content to prevent the hydrogen in the tube from forming hydro-carbons.
2. Good de-gassing properties.
3. High resistance to corrosion.
4. Good workability and weldability.

At the suggestion of INCO's sales and engineering men, Chatham

tried Low Carbon Nickel (carbon content 0.01 to 0.02 per cent), for the tube parts where good workability was one of the important features. The metal proved more than satisfactory, and full advantage of its favorable characteristics was taken in designing certain critical tube parts. Today the Armed Services' VC-1257 tube has one of the largest peak power outputs on record.

Supplying information on suitable alloys that solve problems such as corrosion resistance, heat resistance and high purity is the function of INCO's Engineering Service. Although metals are hard to get at the present time, our engineers will be happy to consult with you on your particular design problems, if you will write, stating your requirements.

Low Carbon Nickel spun anode sleeve 1/4" diam. x 4" deep. Fabricated by E. L. Ewertson, of Hillside, N. J., one of the country's leading spinners. Mr. Ewertson had believed a nickel spinning of this depth and thin wall was impossible until he tried Low Carbon Nickel.

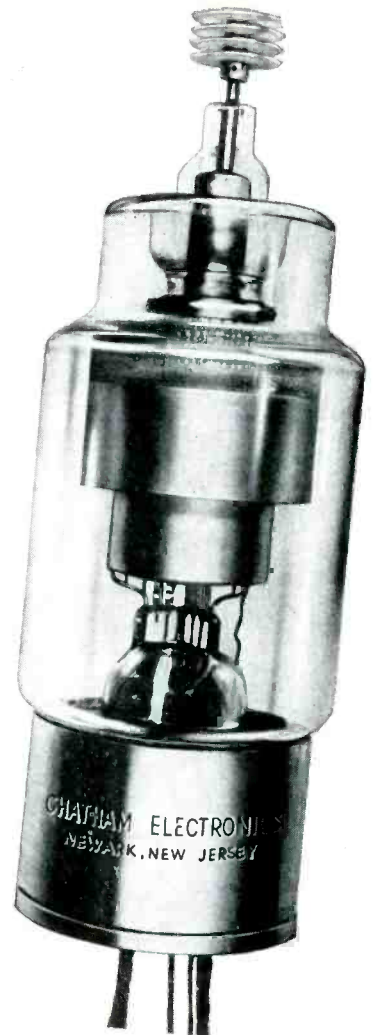

Low Carbon Nickel is produced under controls assuring no more than a 0.02% carbon content. It is resistant to corrosion and can be used in oxidizing temperatures up to 2000°F. Softer than pure nickel, it is slow to work harden. It is chiefly used for difficult deep-drawing and spinning operations.

THE INTERNATIONAL NICKEL COMPANY, INC.
67 Wall Street, New York 5, N. Y.

LOW CARBON NICKEL (ANNEALED) AVERAGE PROPERTIES			
Yield Strength (0.2% offset) 1000 psi	15	Specific Heat (32°-212°F.) Btu./lb./°F.	0.11
Tensile Strength 1000 psi	60	Thermal Expansion Coefficient (32°-212°F.) 10 ⁻⁶ in./in./°F.	7.2
Elongation in 2 in., per cent	50	Thermal Conductivity (32°-212°F.) Btu./sq. ft./hr./°F./in.	420
Hardness Brinell	90	Electrical Resistivity (32°F.) ohms/cir. mil. ft.	50
Density lb./cu. in.	0.321	Tensile Modulus of Elasticity 10 ⁻⁶ psi	30
Melting Point (°F)	2615-2635	Torsional Modulus of Elasticity 10 ⁻⁶ psi	11

LOW CARBON NICKEL

Limiting Composition %

Ni (+Co)	99.00 min.
Cu	.25 max.
Fe	.40 max.
Mn	.35 max.
C	.02 max.
Si	.35 max.
S	.01 max.



Monel® • "R"® Monel
"K"® Monel • "KR"® Monel • "S"® Monel
Nickel • Low Carbon Nickel • Duranickel®
Inconel® • Inconel "X"®



... **SERVICEMEN, AMATEURS,
TECHNICIANS SELECT-**

American Beauty

SOLDERING IRONS

for

**TOP SOLDERING
PERFORMANCE!**

Outstanding performance coupled with durability of construction make American Beauty electric soldering irons the choice of discriminating users in all fields

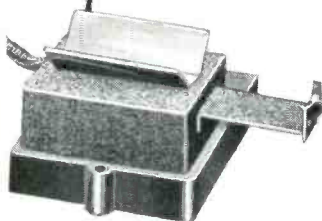

TEMPERATURE REGULATING STAND

Providing heat-regulation for all sizes of electric soldering irons, this stand is adjustable for all heats up to full working-temperature. Assures longer life of iron and tip.

122

For descriptive catalog pages write Dept. 5-23

AMERICAN ELECTRICAL HEATER CO.
DETROIT 2, MICH.

has been reached, an ordinary spark coil may be touched to the external lead of the probe. For large bulbs more power is needed for stable operation, and it is advisable to use some type of radio-frequency power oscillator having an output of 100 to 200 watts.

For tests on picture tubes having metal shells, the r-f oscillator and transformer can be replaced by a high-voltage, low-current, 60-cycle transformer. In this test, the metal shell is grounded. This circuit arrangement is not satisfactory for tubes having glass bulbs, because the high current through the anode button would probably damage the connection between the conductive coating and the button.

Direct-Current Method

In the d-c method (see Fig. 2) the vacuum seal of the bulb is made in the same way as that described for the r-f method, except that a ceramic cylinder rather than a metal one must be used to support the gasket in order to prevent arc discharges during the test. The ceramic and rubber gasket are held in place by screws fastened into the ceramic from the metal plate and then soldered. The surface of the metal plate inside the ceramic cylinder is covered with a flat disc composed of some type of secondary emitter such as sodium silicate with just enough micronized graphite added to give the silicate some conductivity.

To carry out the test, the operator opens the valve to the exhaust pump and exhausts the bulb to a pressure within the range of 5 to 20 microns. When this pressure range has been reached, a positive voltage of approximately 10,000 volts with respect to the metal plate is impressed on the anode button of the bulb. Within this pressure range sufficient ionization occurs to maintain the desired excitation. At higher pressures the system has a tendency to arc; at lower pressures the excitation becomes too faint or ceases. In normal operation positive ions produced in the bulb by collisions strike the secondary emitter and liberate electrons. These electrons form a beam which, collimated by the bulb neck, pro-

ALLIED CONTROL RELAYS

built with

Cleveland PHENOLIC TUBES

ensure

- ★ DEPENDABILITY
- ★ PRECISION PERFORMANCE
- ★ LONG LIFE
- ★ ECONOMY



The Allied Control Co. has built a long and enviable record as a quality supplier of control relays to both private industry and governmental services.

Their S K Relay shown above, is typical of the various Allied Relays in which CLEVELAND CONTAINER tubing provides excellent service.

It is likewise the answer for hundreds of other problems of manufacturers in the electrical industry.

Write today for our new descriptive brochure. Also ask for quotations and samples to meet your exact specifications.

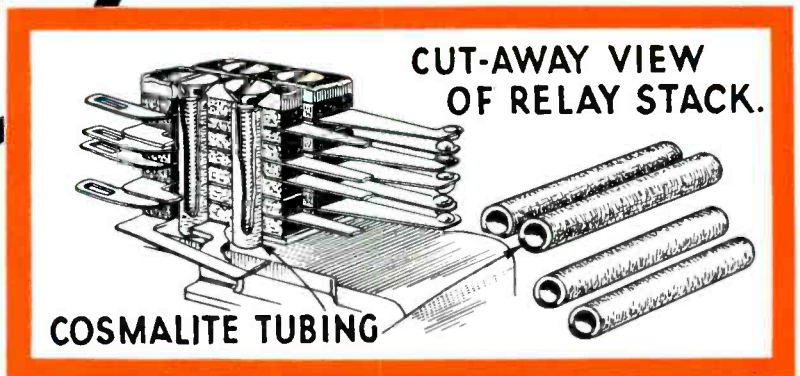

CLEVELITE* and COSMALITE* *Laminated Phenolic Tubing*

combines electrical and physical properties to meet the most exacting requirements.

CLEVELITE is produced in six grades . . .
COSMALITE in four grades . . .
A grade for **EVERY** need.

Cleveland Container's large production facilities further ensure minimum production costs as well as dependable deliveries.

Why pay more? . . .
for the **BEST** call **CLEVELAND**
* Trade Marks

The **CLEVELAND CONTAINER Co.**
6201 BARBERTON AVE. CLEVELAND 2, OHIO

PLANTS AND SALES OFFICES at Plymouth, Wisc., Chicago, Detroit, Ogdensburg, N. Y., Jamesburg, N. J.
ABRASIVE DIVISION at Cleveland, Ohio
CANADIAN PLANT: The Cleveland Container, Canada, Ltd., Prescott, Ontario

REPRESENTATIVES

NEW YORK AREA R. T. MURRAY, 604 CENTRAL AVE., EAST ORANGE, N. J.
NEW ENGLAND R. S. PETTIGREW & CO., 10 N. MAIN ST., WEST HARTFORD, CONN.
CHICAGO AREA PLASTIC TUBING SALES, 5215 N. RAVENSWOOD AVE., CHICAGO

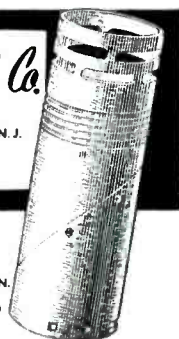

NOW THERE ARE 3

They do everything you want!

They make tough jobs easy!

E-V Slim-Trim DYNAMICS

for TV... Broadcasting... Recording... PA

... for wide range high fidelity response ... for fixed position or man-in-motion ... for ruggedness and versatility ... for exclusive Acoustalloy diaphragm ... for pop-proof pick-up indoors and outdoors

You see ... and hear ... the E-V Slim-Trim on network and local telecasts and broadcasts. You find it in studios and on remote hook-ups. You find it on important PA jobs, too. And you know it's there *because* it has met the most exacting tests... *because* it serves so superbly in every way for voice and music. *First* in dynamic, it has features only *Electro-Voice* can provide. 3 models meet every need!

Ask your E-V Distributor or Send for Full Facts Now!

FOR TELECASTING-BROADCASTING

"655"—Response 40-15,000 c.p.s., ± 2.5 db. Power rating -53. Omnidirectional. Changeable low impedance. Removable swivel. List \$200

"654"—Response 50-14,000 c.p.s., substantially flat. Power rating -55. Omnidirectional. 50-250 ohm impedance selector. Swivel head. List \$90

FOR PUBLIC ADDRESS

"636"—Response 60-13,000 c.p.s., substantially flat. Power rating -55. Omnidirectional. High or low impedance. Swivel head. List \$65

Electro-Voice

401 CARROLL ST. • BUCHANAN, MICHIGAN

Export: 13 E. 40th St., N.Y. 16, U.S.A. Cables: Arlab
MICROPHONES • PHONO-PICKUPS • HI-FI SPEAKERS • SELF-TUNING TV BOOSTERS



duces an illuminated spot on the phosphor screen just slightly larger in diameter than the diameter of the bulb neck. This beam may be deflected by a demountable scanning yoke. The deflection coils may be energized by sinusoidal voltages, provided that the voltages are sufficient to considerably overscan. Under this condition, the scanning rate over the faceplate is relatively constant, so that the illumination is nearly uniform. One voltage can be obtained from the regular 60-cycle line and the other from an audio power oscillator operating at 12 to 15 kilocycles. The use of sinusoidal waveforms instead of sawtooth waves simplifies the circuitry without sacrificing any features needed for detecting flaws in the screens.

Current Transformers for Audio Measurements

BY LAWRENCE T. FLEMING
National Bureau of Standards
Washington, D. C.

A WELL KNOWN METHOD for the measurement of heavy current at low frequency involves the use of a current transformer with a rectifier ammeter connected to its secondary winding. The feasibility of using this method for measuring a current of the order of a few amperes is probably frequently overlooked. Moreover, measurements made on an improvised arrangement of this type have shown fair accuracy over the range 50 to 50,000 cycles per second.

This note is written to call attention to the following attractive features of this method: (1) the scale is nearly linear; (2) the instrument can withstand considerable overloading without injury; (3) the power required for indication is less than for thermal-type ammeters. One may improvise an arrangement of components on hand in many laboratories that will give satisfactory performance over the audio range.

Thus for the measurement of the order of one to three amperes we have improvised a current transformer through the use of a

Seletron SELENIUM RECTIFIERS

May be up your alley, too!

... AS THEY ARE FOR
THE BRUNSWICK-BALKE-
COLLENDER COMPANY

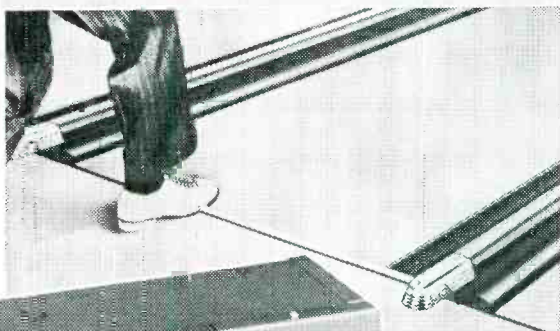

Illustrated above is the "Tel-E-Foul" control box. When the bowler oversteps the foul line the electronic brain conveys an impulse causing a light to flash above the alley. A 75 MA SELETRON miniature is built into the control box on each bowling lane.

The new "Tel-E-Foul," photo-electric Foul Indicator produced by The Brunswick-Balke-Collender Company, famous manufacturer of bowling equipment, includes 75 MA SELETRON miniatures in its electronic circuits.

SELETRON Selenium Rectifiers are the choice of an increasing number of manufacturers in diversified fields because they are so thoroughly dependable under all types of grueling conditions. SELETRON is available in the miniature sizes required for radio, TV and other electronic circuits, all the way up to heavy duty power stacks used in a wide range of industrial applications.

Whenever *you* meet up with a power conversion problem, no doubt SELETRON engineers can be of substantial assistance in recommending the right rectifier for your needs. Write us today!

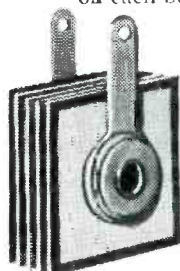

Seletron

SELETRON DIVISION

RADIO RECEPTOR COMPANY, Inc.



Since 1922 in Radio and Electronics



Sales Dept.: 251 W. 19th St., New York 11, N. Y. • Factory: 84 N. 9th St., Brooklyn 11, N. Y.

RCA TUBES ...

*The complete line
for industry ...*



High-power Triode, RCA-5770

R-f output—100 KW!

The RCA-5770 water-cooled triode delivers 100 kw in r-f heating services—at a filament power of only 3.1 kw! Thoriated-tungsten filament design . . . taking 60% less power than pure-tungsten filaments . . . simplifies bulb and filament-seal cooling. Low grid inductance and low plate capacitance widen the usefulness of the tube at higher frequencies.

Like its predecessor, the famous 9C21, RCA-5770 embodies the same rugged, long-service features that make RCA tubes the standard of comparison! Your local RCA Tube Distributor has complete information. For quick service, simply reach for your phone.



RADIO CORPORATION of AMERICA
ELECTRON TUBES HARRISON, N. J.

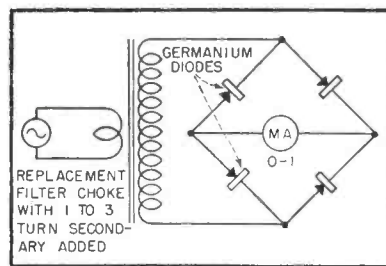

FIG. 1—Basic circuit shows use of current transformer for audio-frequency measurements

replacement choke, constructed a suitable bridge-type rectifier using germanium diodes, and for current indication used a one-milliamper d-c instrument. Figure 1 shows the circuit arrangement. In one case the rectifier-instrument combination employed four-IN34 crystal diodes and a 1-milliamper 50-ohm indicating instrument.

The transformer was made by winding 1 to 4 turns around the outside of the winding of an ordinary radio replacement-type choke coil and interleaving the core laminations to secure low reluctance and thus low magnetizing current. The secondary of the transformer had an inductance of about 40 henrys after interleaving and a transformer ratio of the order of 1 to 1,000.

Such an arrangement in which the reactance of the secondary of the transformer is quite high, offers the advantage that the d-c milliammeter may be shunted by a resistor to secure the desired nominal value of current ratio for the combination. This procedure has little adverse effect on frequency response of the combination for adjustments as large as 30 percent of the full scale value of the milliammeter. Further adjustment may of course be made by changing the number of primary turns.

It should be noted that the transformer is operated as a true current transformer, because the equivalent impedance of this combination as seen from the primary will ordinarily be low compared to the impedance of the source, and the secondary reactance is high compared to the impedance of the rectifier-instrument load connected across it. In this respect the arrangement is quite like the much

they

may

look

alike,

but:

there

is

only

one

C-D

COMPACT! DEPENDABLE!

Best... by Field Test

Type BBR MINIATURE ELECTROLYTIC CAPACITORS

anode risers connected
directly to outer leads

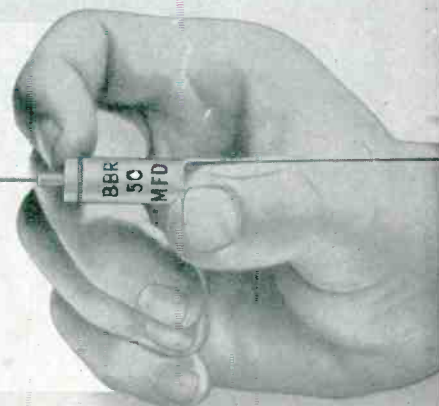

... new construction eliminates shorts to the container!

Another C-D first! Positive lead, of round aluminum wire, is clamped to special aluminum center piece providing continuous metallic contact from foil to terminal lead. No foreign material sandwiched between inner and outer leads—a consistent cause of floating opens and high resistance contacts. Also eliminates shorts in container. Other features are:

High-purity aluminum electrodes—low electrical leakage! Cellulose-acetate wrap prevents "contamination" during assembly! Electrolyte centrifuged into container—fills

section completely; provides reserve fluid for many years' use! Rubber bakelite insulation washer permits perfect seal! Stable electrolyte—a C-D exclusive—permits long shelf and operating life!

For further information on these and other C-D electrolytics, write for catalog. CORNELL-DUBILIER ELECTRIC CORPORATION, Dept. K-71, South Plainfield, New Jersey. Other plants in New Bedford, Brookline and Worcester, Mass.; Providence, R. I.; Indianapolis, Ind., and subsidiary, The Radiart Corp., Cleveland, Ohio.



CONSISTENTLY DEPENDABLE

CORNELL-DUBILIER

CAPACITORS • VIBRATORS • ANTENNAS • CONVERTERS



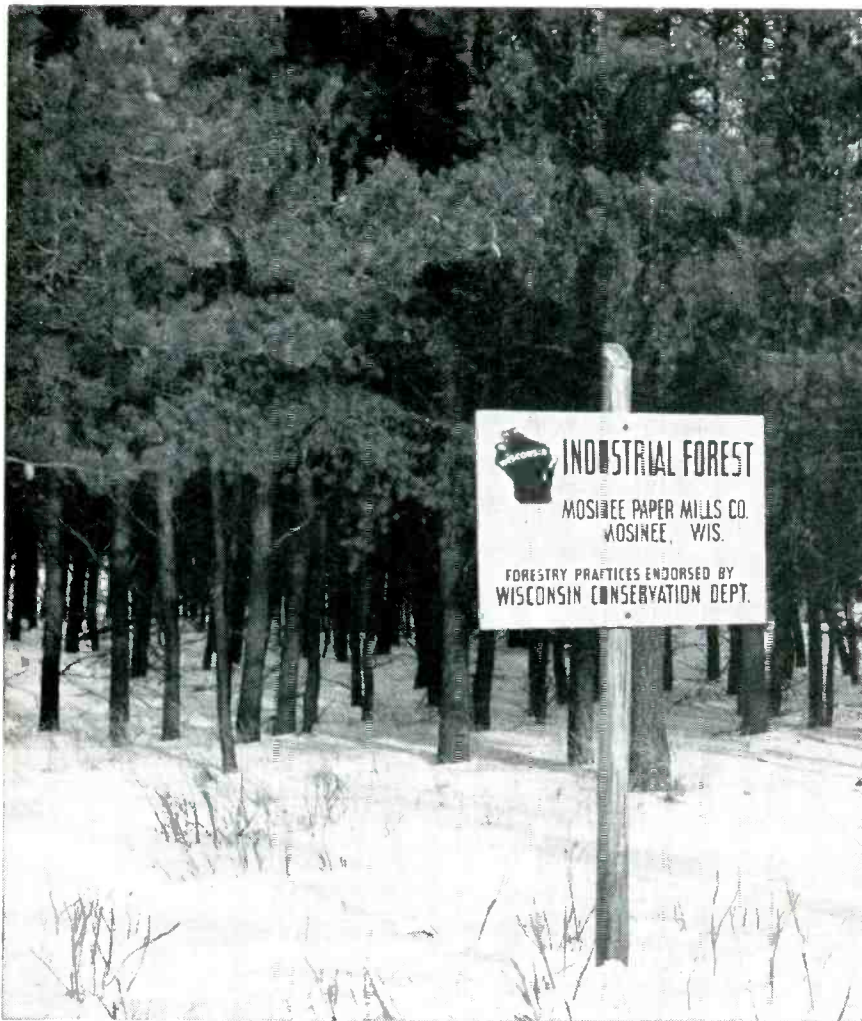

Many Industrial Products Start Here



Mosinee "fibres that work for industry" depend upon a reforestation program which not only assures trees for the future but protects our forests today. Mosinee Industrial Forests, augmented by aid in planting waste land, make raw material supply secure and ever-growing. From seedlings to technically controlled papers, MOSINEE safeguards every step in the process of making Mosinee Fibres that work for industry.

MOSINEE PAPER MILLS CO., Mosinee, Wis.



MOSINEE
makes fibres work for industry

larger current transformers used in measuring large currents at power frequencies. Its purpose is to provide an impedance and voltage level at the secondary which is suitable for the linear and efficient operation of a rectifier instrument.

The essential requirement in the transformer design is that the secondary reactance be high compared to the total d-c resistance in the secondary circuit, at the lowest frequency at which the instrument is to be used.

High-Frequency Limitations

In Fig. 2 are shown experimental curves of voltage drop and instrument error with respect to frequency, for an arrangement of the kind shown in Fig. 1. The error at low frequencies depends on the ratio of the impedance of the rectifier instrument to the impedance looking into the secondary of the transformer, as will be discussed later. Error does not begin to be noticeable at high frequencies until slightly above 50 kc. An increase in voltage drop across the primary of the transformer is, however, evident some time before this, beginning at 10 kilocycles.

The high-frequency limitations cannot be readily estimated on paper because at high audio frequencies the effect of distributed capacitance in the secondary coil windings will be to shunt secondary current away from the rectifier instrument and thus change the effective current ratio. Essentially the method should be good at the higher frequencies because the rectifier instrument impedance is comparatively low and in effect constitutes a short circuit of the high-impedance secondary winding. Thus the voltage developed across sec-

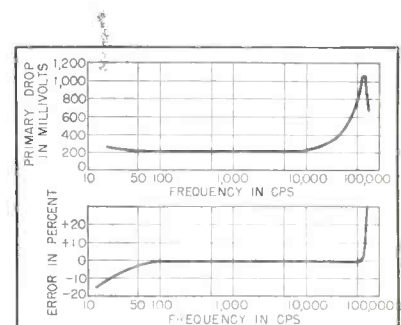

FIG. 2—Curves show error and primary voltage drop at different frequencies

Do You Know?



...BURGLAR ALARM SYSTEMS,

WHICH PROTECT BANK DEPOSITS TOTALLING MILLIONS OF DOLLARS, RELY FOR THEIR UNFAILING PERFORMANCE ON TELECHRON TIMING MOTORS.

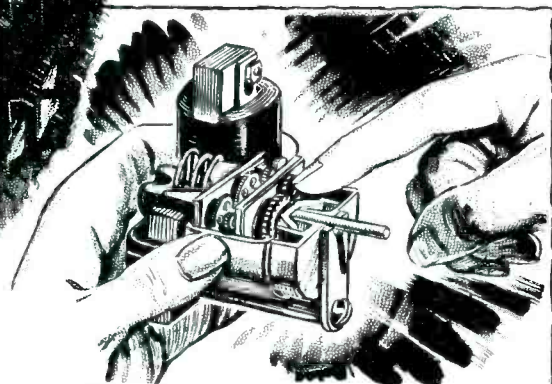

...SPUR GEARS

OF ALL TELECHRON TIMING MOTORS ARE HOBBED...NOT STAMPED...FOR TRUER, QUIETER OPERATION AND LONGER LIFE.

...ACCURATE ELECTRIC TIMING,

FOR THE MOST PART, RESULTS FROM THE TELECHRON SYNCHRONOUS MOTORS IN THE MASTER CLOCKS WHICH ARE USED TO CONTROL FREQUENCIES IN POWER STATIONS.

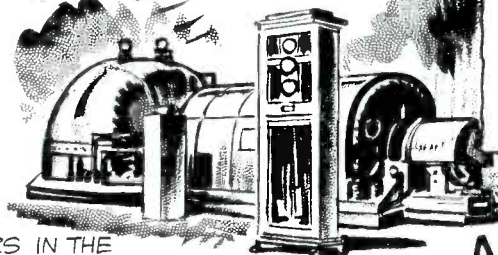

...ALL THE FACTS

ABOUT TELECHRON TIMING MOTORS ARE CONTAINED IN BULLETIN IS-120.

CHARTS, TORQUE RATINGS AND COMPLETE SPECIFICATIONS MAKE IT EASY FOR YOU TO SELECT THE RIGHT MOTOR FOR SUCH APPLICATIONS AS: HEATING CONTROLS, APPLIANCE TIMERS, INSTRUMENTATION, PROCESS TIMERS, TRAFFIC CONTROLS, ETC. WRITE FOR BULLETIN IS-120 TODAY. TELECHRON DEPARTMENT, GENERAL ELECTRIC COMPANY, 47 UNION ST., ASHLAND, MASS.

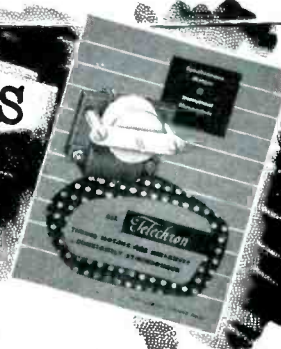

...SKILLED HELP ON "EMERGENCY" CONTRACTS

IS AVAILABLE AT TELECHRON PLANTS. NEW BROCHURE, "PRECISION ON THE PRODUCTION LINE," GIVES A QUICK PICTURE OF PERSONNEL CAPABILITIES AND MASS-PRODUCTION FACILITIES. WRITE FOR YOUR COPY TODAY.



ALL TELECHRON TIMING MOTORS ARE

INSTANTLY...CONSTANTLY SYNCHRONOUS

Telechron

the world's toughest transformers

must "take" this torture, before they take on your tough jobs...

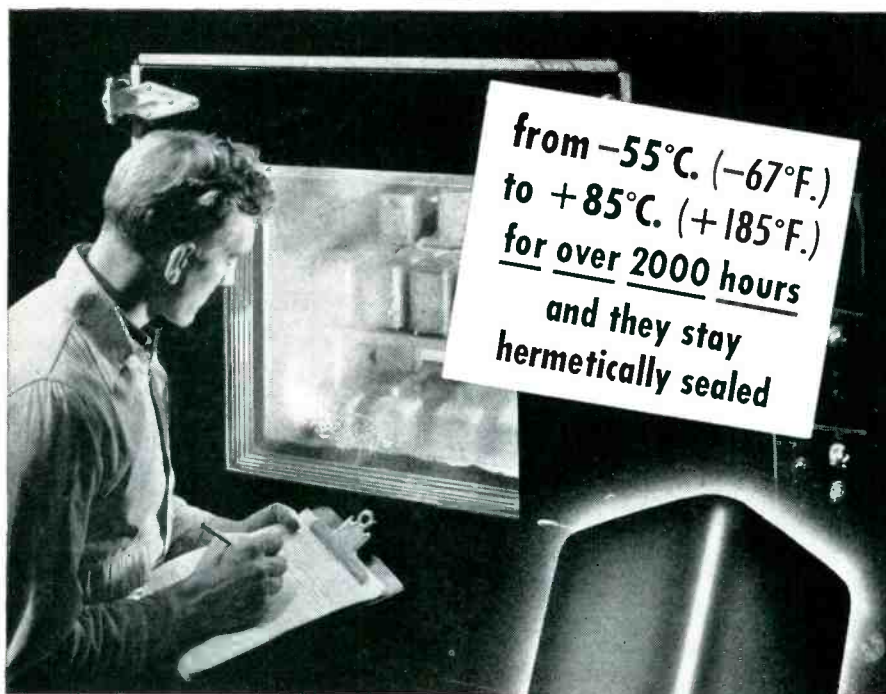

from -55°C. (-67°F.)
to $+85^{\circ}\text{C.}$ ($+185^{\circ}\text{F.}$)
for over 2000 hours
and they stay
hermetically sealed

CHICAGO



MIL-T-27 transformers are really rugged the complete line that meets military specifications

CHICAGO MIL-T-27 Transformers win their spurs in every conceivable "torture chamber" test. Two hundred and forty-seven cycles of alternating heat and cold for over 2400 hours fail to break the seal or cause failure of these rugged CHICAGO units expressly designed for military and special applications. CHICAGO's unique bushing design and construction, and exclusive process of bonding steel base covers in seamless drawn-steel cases by deep-seal soldering—insure perfect sealing, complete dependability and continuous service under the most adverse conditions. Your electronic parts distributor can supply the complete range of CHICAGO MIL-T-27 Transformers: Power, Bias, Filament, Filter, Audio. These stock transformers may be incorporated in your equipment with full assurance that they will *completely* meet all MIL-T-27 specifications.



SEND FOR FREE CATALOG

Have the full details on CHICAGO'S New Equipment Line—covering all MIL-T-27 units as well as famous Sealed-in-Steel transformers geared to today's circuit requirements. Write for your free copy of this valuable catalog today, or get it from your distributor.

CHICAGO TRANSFORMER

DIVISION OF ESSEX WIRE CORPORATION

3501 ADDISON STREET • CHICAGO 18, ILLINOIS

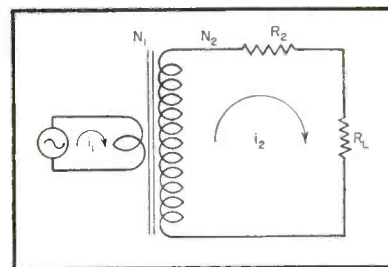

FIG. 3—Equivalent circuit used in calculating low-frequency performance

tions where distributed capacitance is high would normally be quite low. Secondary resonance should therefore only become troublesome at rather high frequencies.

Design improvements should be possible through minimizing secondary leakage reactance, through reducing the number of primary and secondary turns (commensurate with the required secondary reactance) in order to reduce stray and distributed capacitances, and through the proper selection of core material if it were desired to increase the upper frequency limit. On the other hand this might restrict the low-frequency useful limit and make it desirable to have two transformers with overlapping frequency ranges—one for low frequencies and the other for very high audio frequencies for use with the rectifier-type instrument. It is very likely that the frequency range can be substantially widened by employing high permeability core material, and reducing the number of secondary turns to the minimum required for the necessary inductance.

This method has the inherent wave-form limitation of rectifier-type instruments in that the deflection of such instruments are proportional to the average rather than the effective value of current. Thus if calibrated on a sine wave to read effective values they do not indicate properly on distorted wave-forms. The arrangement, however, is not particularly sensitive to change in resistance of the rectifiers with temperature as this effect is swamped by the high reactance of the transformer secondary. Except on distorted wave-forms an arrangement of this sort should be considered in the 5-percent-accuracy class unless special precautions are taken in its calibration.

The circuit behavior for low fre-

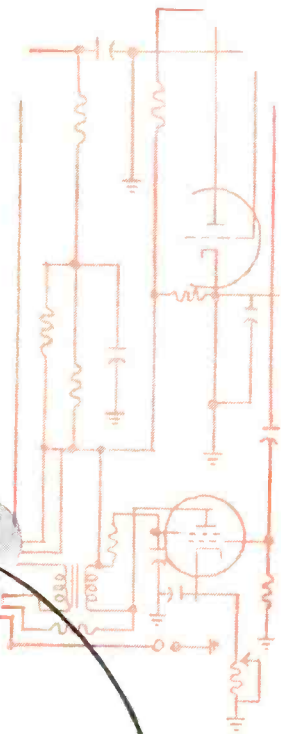
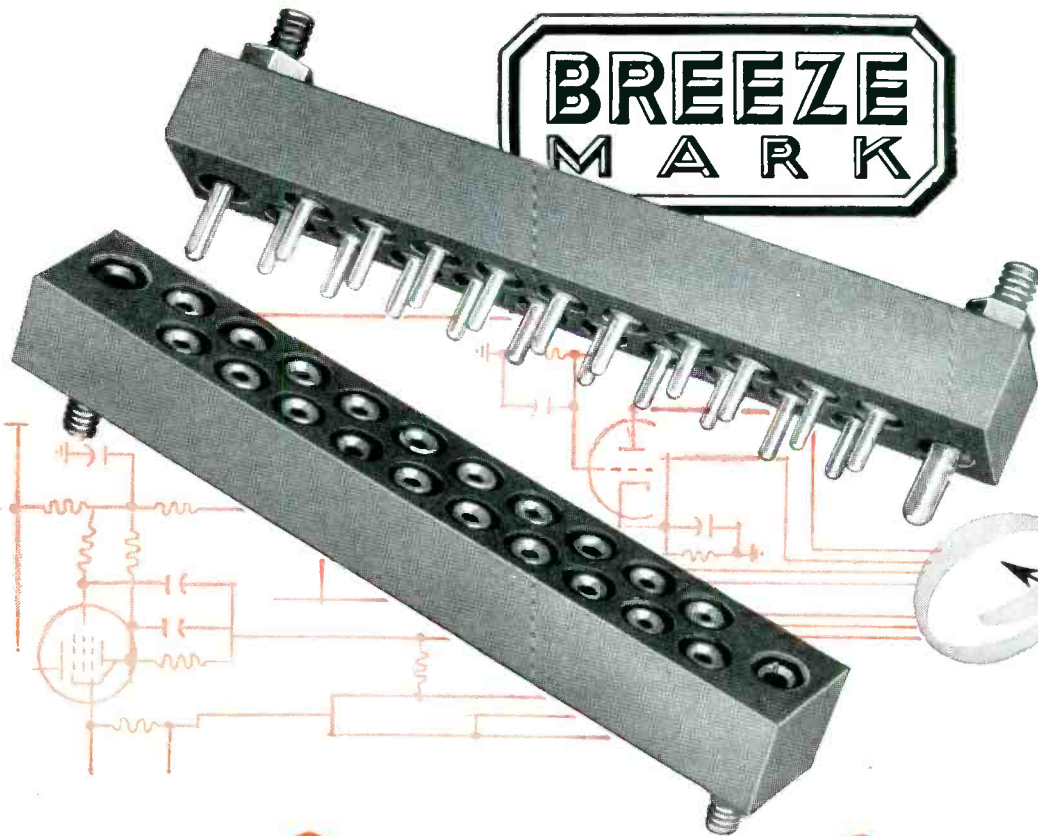

Connector Problem?

...We'll take it from **HERE**

Good ideas for electronic circuitry sometimes run afoul of connector problems. Maybe existing connector units won't hold air pressure gradients, won't stand the heat, aren't rugged enough for the job. Or maybe it's a question of altitude, or under-water application. But if you can sketch the circuit, we'll take it from there. We've engineered so many special connectors, solved so many "impossible" problems, that whatever the requirements are, we can usually provide the answer.



Lightweight actuators for any requirement.



Job engineered, welded-diaphragm bellows.



Flexible conduit and ignition assemblies.



Aero-Seal vibration-proof hose clamps.

WRITE TODAY for specific information, or send us your sketches. We'll forward recommendations promptly.

BREEZE Special CONNECTORS

BREEZE CORPORATIONS, INC.

41 South Sixth Street

Newark, New Jersey

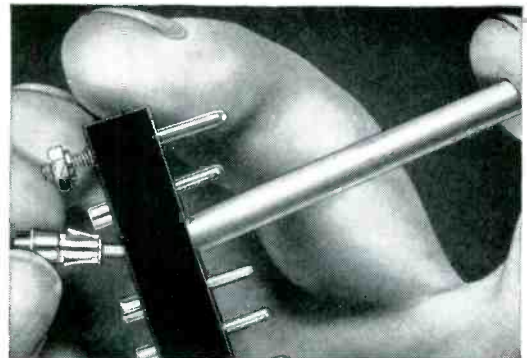

Removable pins in Breeze connectors speed soldering, save time, trouble. Pins snap back into block.

Standard RADIO INTERFERENCE and FIELD INTENSITY Measuring Equipment

Complete Frequency Coverage - 14 kc to 1000 mc!



VLF!

NM - 10A

14kc to 250kc

Commercial Equivalent of AN/URM-6.

Very low frequencies.



HF!

NM - 20A 150kc to 25mc

Commercial Equivalent of AN/PRM-1. Self-contained batteries. A.C. supply optional. Includes standard broadcast band, radio range, WWV, and communications frequencies.

VHF!

NMA - 5

15mc to 400mc

Commercial Equivalent of TS-587/U.

Frequency range includes FM and TV Bands.



UHF!

375mc to 1000mc **NM - 50A**

Commercial Equivalent of AN/URM-17.

Frequency range includes Citizens Band and UHF color TV Band.



These instruments comply with test equipment requirements of such radio interference specifications as JAN-1-225, ASA C63.2, 16E4(SHIPS), AN-I-24a, AN-I-42, AN-I-27a, AN-I-40 and others.

STODDART AIRCRAFT RADIO CO.

6644-A SANTA MONICA BLVD., HOLLYWOOD 38, CALIFORNIA

Hillside 9294

quencies may be analyzed as follows:

Referring to Fig. 3, the current ratio is

$$\frac{I_2}{I_1} = K \frac{N_1}{N_2} \left(\frac{1}{1 - j \frac{R_2 + R_L}{\omega L_2}} \right)$$

where I_1 = primary current, I_2 = secondary current, K = coupling coefficient, N_1 = primary turns, N_2 = secondary turns, R_2 = resistance of secondary winding, R_L = secondary load resistance, and L_2 = secondary inductance. To retain a constant ratio we must have $\omega L_2 \gg (R_2 + R_L)$

This determines the lower frequency limit. For example, for a 5-percent error at the low frequency end of the range,

$$\left[1 + \left(\frac{R_2 + R_L}{\omega L_2} \right)^2 \right]^{\frac{1}{2}} = 1.05$$

Approximately,

$$\left(\frac{R_2 + R_L}{\omega L_2} \right)^2 = 0.1$$

so

$$\omega L_2 = \frac{R_2 + R_L}{0.31} = 3.1 (R_2 + R_L)$$

If $R_2 + R_L = 600$ ohms, and the low-frequency limit is taken at 20 cps, $L = 14.8$ henrys.

REFERENCE

(1) Edgecombe and Ockenden, "Industrial Electrical Measuring Instruments", p 175, Sir Isaac Pitman and Sons, 1933.

Improved Terratex

CONSIDERABLE ACTIVITY has been devoted to the development of a satisfactory mica substitute. It has been the hope of those working in this field to develop a material having all the physical and chemical characteristics of mica. We are all more or less familiar with the progress which has been made in this field, and certainly that progress has been significant. Nevertheless, an easily producible material satisfactory for vacuum-tube applications, which are very demanding indeed, has not yet been reported.

In a paper presented to the AIEE in 1948, T. R. Walters, of G-E Works Laboratory at Pittsfield, reported the original development of a material known as terratex. The

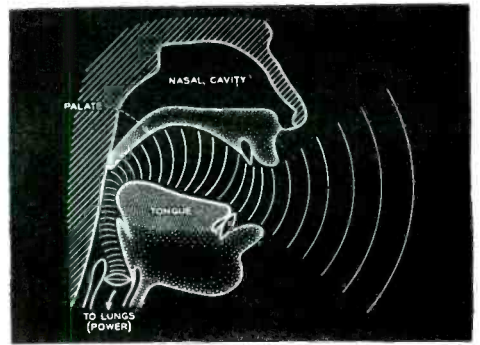
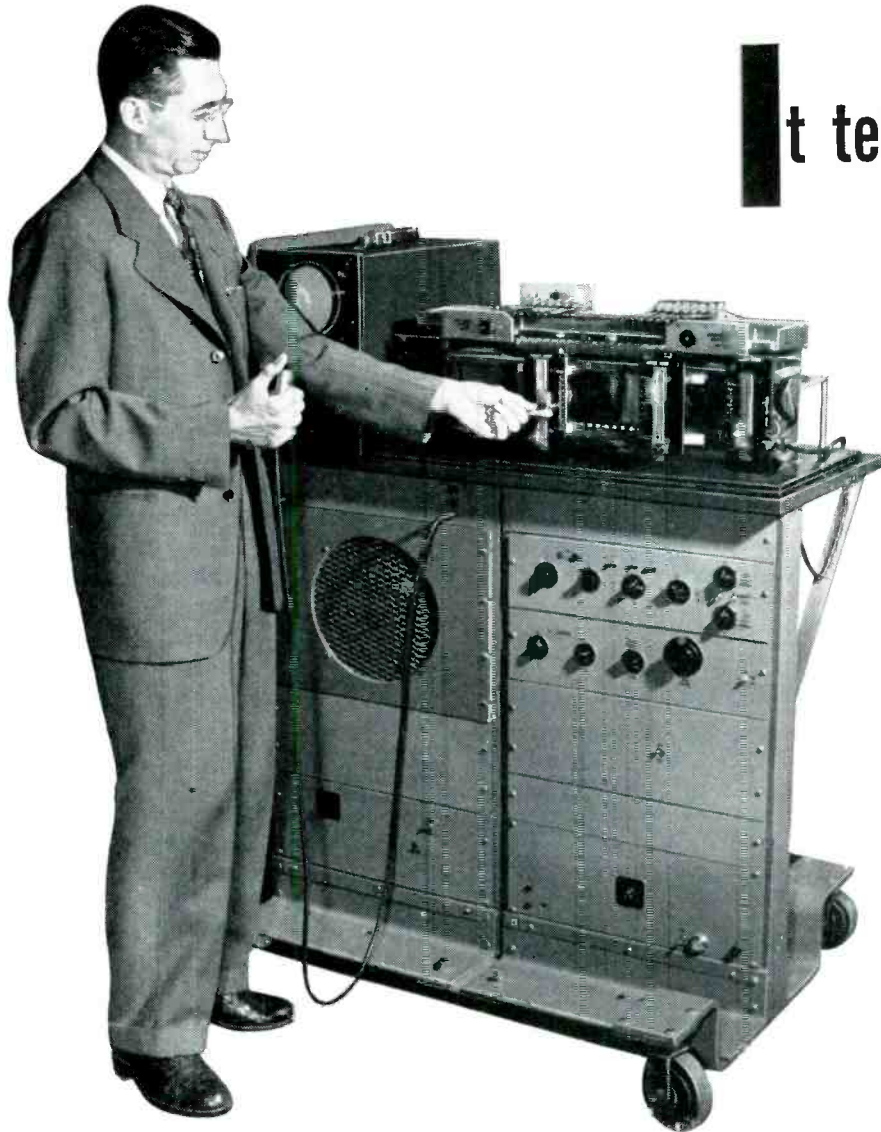

It tells how you talk

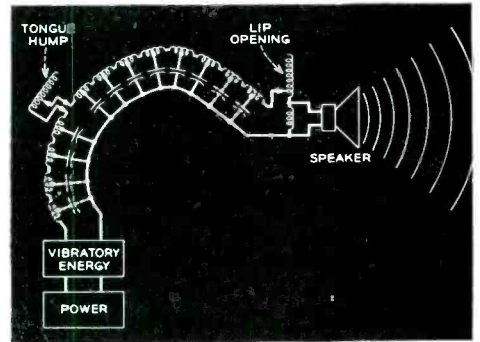

The machine at the left is saying "Ah!" It's the new electrical vocal system developed at Bell Laboratories. Top sketch shows human vocal system also saying "Ah!" The electrical model is sketched below it. Energy source at bottom of "tract" can emit a buzz sound, like vocal cord tone, or the hiss sound of a whisper.

No one else speaks exactly like you. Each of us uses different tones to say the same words. To study and measure *how* we make speech, acoustic scientists of Bell Telephone Laboratories built a model of the vocal system.

Electric waves copy those of the vocal cords, electric elements sim-

ulate the vocal tract, and, by adjustments, vowels and consonants are produced at pitches imitating a man's or woman's voice.

Using this electrical system, telephone scientists will be able the better to measure the properties of people's voices. Knowing more about speech they can find better

and cheaper ways to transmit it.

This is another step in the research at Bell Telephone Laboratories which pioneered the exact knowledge of speech. Past work in the field is important in today's fine telephone service. A still deeper understanding of speech is essential in planning for tomorrow.

BELL TELEPHONE LABORATORIES

Exploring and inventing, devising and perfecting, for continued improvements and economies in telephone service.



ALDEN COMPONENTS FOR PLUG-IN UNIT CONSTRUCTION

Until recently there has been no one place where components specifically designed for plug-in unit construction were available. It was necessary for engineers to design and have parts custom made or improvise with standard components in makeshift arrangements. To provide the type of design necessary, Alden engineers are working with the industry developing a whole series of components specifically for plug-in construction.

The first problem undertaken by Alden engineers was a base specifically for plug-in unit construction. . . . The conventional tube type bases proved unsatisfactory; they didn't stand up, the boss broke and the pins bent. To overcome these difficulties Alden designed an entirely new base . . . the Non-Interchangeable Series bases have no molded center boss to break, pins are strong and stubby—do not bend or break out and are Non-Interchangeable to prevent danger of mismatching and costly burned out units.

Out of this work we feel that Alden's is the one place where you now can take your unitizing problems and obtain the standard bases, sockets, mountings and housings to answer most of your needs. As illustrated below, the Alden Non-Interchangeable and miniature bases have tremendous flexibility and are fast becoming the standard for plug-in construction.



20 Pin Non-Interchangeable Bases & Sockets

The scope of the Alden "20" base as a mounting medium is almost unlimited . . . cards, brackets and balls can be easily and securely attached with standard assembly tools. For holding components and miniature tube sockets the Alden Terminal Card Mounting System on the Alden Base gives ease of layout and wiring assembly. Open units for heat dissipation or shielded units for protection against dust or rough handling both lend themselves to mounting on the Alden Base with the same facility.

11 Pin Non-Interchangeable Bases & Sockets

Smaller than the "20" but with the same features, the Alden "11" base and sockets are rugged for long life and Non Interchangeable to isolate critical voltages or signals and prevent burned out units. The retention force of pins and socket clips can be varied from light to heavy. Locating rings and alignment indicator quickly center base and socket for insertion. These and other features make it practical to incorporate plug-in construction in your design.

7 and 9 Pin Miniature Bases & Sockets

Miniature and sub-miniature circuits, potted circuits, and miniaturized components easily become compact, sturdy plug-in units with the Alden 7 and 9 pin miniature plug-in bases and sockets. A wide selection of housings and mounting components are available for use with these bases.

Of particular importance is the Alden Terminal card Mounting System. Miniature circuits can be assembled on the card and the assembly can be mounted on the base to form a complete miniature unit.

untreated paper-like sheet of terratex is mechanically weak, but a process has been developed to give it desirable physical characteristics. To make it suitable for use in vacuum tubes, the spacer material is impregnated with partially hydrolyzed ethyl silicate which, when dried, yields the tough terratex that is usable for spacers. Care must be taken in the choice of hydrolyzing acids used when forming silicate-treated terratex for vacuum tube use so that contaminants are not introduced which would be harmful in the tube. Although the processing of the spacer material is not yet complete at this stage in the manufacturing process, the terratex in this condition can be stored or shipped conveniently without noticeable deterioration.

Vacuum tube spacers have some dimensions with very close tolerances. To assure reasonable uniformity of spacers, the material should punch cleanly and easily and should not flake or split when handled. In addition, it should retain a certain amount of resiliency in order for the points of the spacer which contact the bulb of the miniature tube to yield slightly as the mount is inserted in a bulb which is slightly out of round or undersize. Chemically, the material should be stable so that storage problems are minimized and so that uniformity can be achieved from one tube production lot to another. Electrically, the material should have high resistivity and a low dielectric constant. In addition, for vacuum tube applications considerable surface roughness is desirable

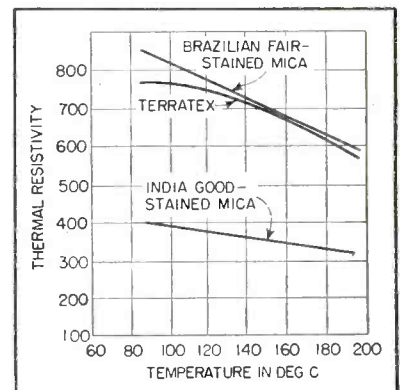

FIG. 1—Thermal resistivity of terratex is almost the same as that of Brazilian fair-stained mica



ALDEN PRODUCTS COMPANY

117 NORTH MAIN STREET, BROCKTON 64, MASSACHUSETTS



Complete COAXIAL CABLE ASSEMBLIES

Now available from
Federal

This new service offers the same "Precision Production" that made Federal the outstanding name in H-F cables

MORE than good cable and good connectors are needed to make good assemblies. The secret of their efficiency and dependability is *the skill with which the two are joined!*

And that's where Federal's new coaxial cable assembly service is *tops*. Federal has the experience to meet the highest requirements of connector installation . . . a know-how based on years of pioneering, developing and manufacturing cables of superior quality . . . a know-how that achieved the production of tremendous quantities

of complete assemblies for the armed services during World War II.

An important feature of Federal's new service for users of coaxial cables is the fact that Federal holds approval of the U. S. Signal Corps and the U. S. Air Force for the new low-temperature, non-contaminating thermoplastic jacketed cables—an *original development by Federal*. For quick action on quotations, send us your detailed drawings *now*—with full information on requirements. Address your inquiry to Dept. F-513.

Manufacturer of America's most complete line of solid dielectric cables

Federal Telephone and Radio Corporation



FEDERAL TELECOMMUNICATION LABORATORIES, Nutley, N. J. . . . a unit of IT & T's world-wide research and engineering organization.

SELENIUM-INTELIN DIVISION—100 KINGSLAND ROAD, CLIFTON, NEW JERSEY

In Canada: Federal Electric Manufacturing Company, Ltd., Montreal, P. Q.

Export Distributors: International Standard Electric Corp., 67 Broad St., N. Y.



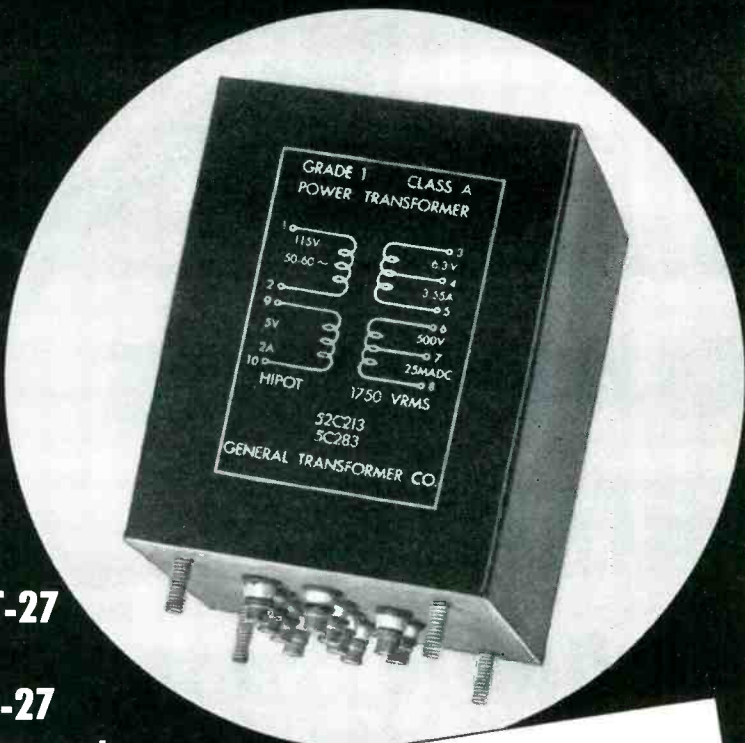

For
JAN-T-27
or
MIL-T-27
Requirements

Specify GTC Transformers

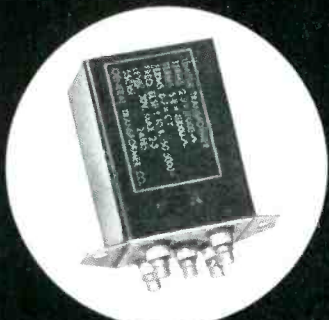

Our 23 years' experience in transformer manufacturing is your assurance of quality.

Our highly competent engineering staff and modern conveyORIZED assembly plant provide efficient design and prompt delivery of hermetically-sealed transformers.

We suggest that "GTC" is worthy of your consideration when you require transformers to meet military specifications.

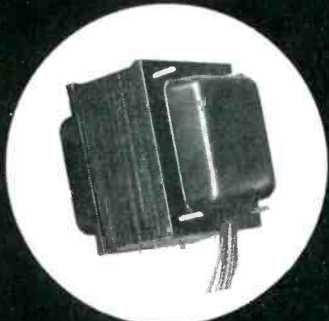

PRIME and SUB-CONTRACTORS are invited to write.

Our new, self-contained plant, complete with metal-working and tool-making facilities, is available.



GENERAL TRANSFORMER COMPANY

servicing industry since 1928

18240 Harwood Avenue, Homewood, Illinois
(Suburb of Chicago)

in order to minimize the development of leakage paths during the operating life of the tube.

For vacuum tube applications, particular characteristics of the spacer material are of special significance. A comparison of the thermal resistivities of mica and terratex is shown in Fig. 1. From these curves it can be seen that terratex has approximately the same thermal resistivity as Brazilian fair-stained mica and is somewhat superior to Indian good-stained mica. The characteristics are, of course, difficult to measure accurately due to the variation in air spaces in the mica specimens. An interesting comparison of performance is that the cathode temperatures are about the same for tubes spaced with 20-mil terratex or 10-mil mica.

The effects of temperature upon the insulation resistance of mica and terratex are essentially the same over the normal temperature range for the mica and terratex specimens. Measurements have been made of power factor and dielectric constant to 50 megacycles. At this frequency the power factor of mica and terratex are about the same, and the dielectric constant is approximately 3.5 as compared to the mica constant of 4.5 for the specimens measured.

Figure 2 shows an operating time comparison between the transconductance of type 12AT7 tubes spaced with micas and the same type tubes, identically processed, spaced with processed and plain terratex spacers. It can be seen from these curves that the results are quite comparable and satisfactory. Those familiar with the characteristics of the type 12AT7 probably realize that this is a tube extremely susceptible to modifica-

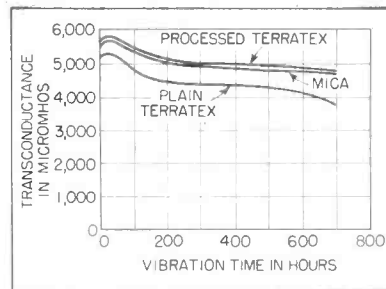

FIG. 2—Curves show desirable characteristics of terratex for use in vacuum tubes that will encounter vibration



BRIDGEPORT BRASS COMPANY

COPPER ALLOY BULLETIN



MILLS IN BRIDGEPORT, CONN. AND INDIANAPOLIS, IND.—IN CANADA: NORANDA COPPER AND BRASS LIMITED, MONTREAL

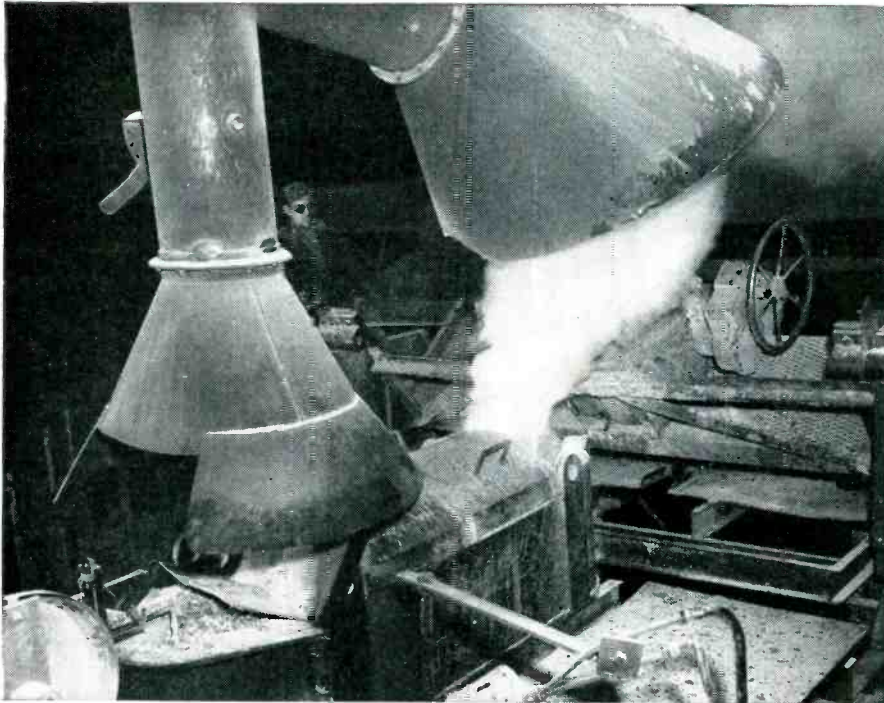

Continuous Casting of Brass at Bridgeport Brass Co., Bridgeport, Conn.

Brass Scrap Situation and Its Effect on Brass Production

Copper and zinc, essential metals for both military and civilian needs, have been in short supply for many months and the situation has been growing worse. After taking care of the mounting volume of DO orders, there is not enough remaining to take care of civilian needs even at the reduced allotment.

As far as we can learn, there has not been a sufficient increase in the production of copper and zinc to satisfy this unprecedented demand and to take care of the requirement of the government stock piling, defense and foreign rearmament programs.

The high volume of production of brass mill products during 1950 and the early part of 1951, has been possible only because the mills have dipped into their metal inventories which are at their lowest ebb today.

From the brass mill standpoint, the short supply of zinc has been critical

because it is needed for alloying with copper to produce brass. Zinc acts as a means of stretching the available supply of copper because when alloyed with 100 pounds of copper it can result in about 145 pounds of brass. This increased tonnage will serve a larger number of users.

However, to augment the supply of zinc and copper, the brass mills use clean brass scrap, viz., clippings, rod ends, and shavings generated during metal goods fabrication. The scrap is added to the melt with new metal and is eventually turned into new mill products.

It has always been the custom for the brass mills to buy back the brass scrap from their mill products, customers and metal dealers at definite published prices which reflect the prevailing prices of new copper and new zinc.

Today, because of the voracious de-

mand for brass scrap, its price has been raised considerably beyond that of virgin metal. As a result, a portion of this scrap, which would ordinarily be returned to the brass mills, has been diverted to other channels.

The serious shortage of copper and zinc, plus the insufficient brass scraps being returned to the mills explains in part why the brass mills are operating on a reduced schedule and are not able to fill the many orders which have piled up.

Some Scrap Diverted

The scrap situation can be improved if metal goods manufacturers will make sure that *all* their scrap is returned to the brass mills. Although most manufacturers make it a practice to do so, there are some smaller ones who think that their scrap generation is insufficient to count. However, when the scrap generation of all small manufacturers are added up, the total becomes worthwhile.

It is true that in some cases brass scrap can fetch higher prices than that offered by the brass mills. Unfortunately, if this scrap does not find its way back to the brass mills, the brass mill tonnage is reduced and all brass users suffer.

How Brass Users Can Help

Here are a few suggestions which, if followed by metal goods manufacturers, would help the scrap situation considerably.

1. Store all scrap in clean containers, keeping it separated by alloy and properly identified.
2. When a sufficient quantity has been collected, notify the brass mill for whom it is intended. Give details as to weight, alloy, character of scrap. Ask the brass mill to collect it either in their own trucks or to designate the particular scrap dealer which does this work for the brass mill.
3. If you know where there are clippings of zinc resulting from manufacturers' cups or stampings, or scrap copper wire or other forms of good clean scrap of brass, bronze or copper not generated by brass goods manufacturers, please notify your supplier of brass mill products. (6867)

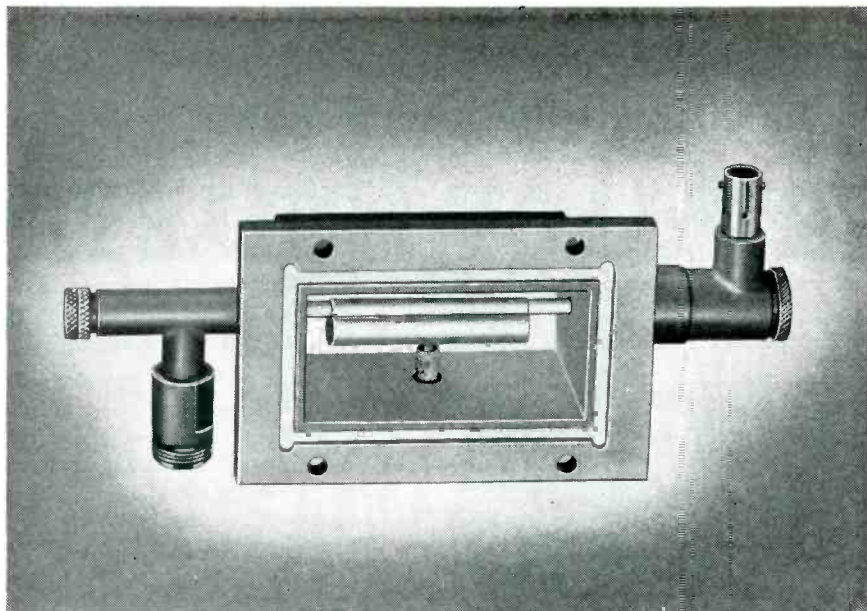

Broad Band Mixer...

by Terpening

This mixer was designed by the Terpening engineering staff to meet a performance specification for low loss operation over a broad segment of the S Band. Local oscillator input and adjustable coupling probe are on the left; IF output at right. Important element is the cylindrical structure attached to the inner co-ax conductor within the waveguide section. This Terpening-developed element acts as a broad-banding transformer and permits high efficiency operation from 2700 to above 3000 mc. VSWR, with a JAN-approved crystal connected as shown, is less than 2.2/1 over the entire frequency range.

This is another example of the type of help Terpening is set up to provide prime contractors on microwave transmission line systems—from design through production. Although our engineering staff, laboratories and fully equipped shop are busy with government contracts, we will be happy to talk with you about your needs on similar work.

tions of any type. Consequently, satisfactory experience with this tube represents a considerable achievement as far as utilization of the new spacer material is concerned. Another interesting result was obtained when a number of terratex-spaced and mica-spaced 6J5-GT tubes were tested on a vibration-life test.

Figure 3 shows the remarkable difference in the vibration output characteristics of the two lots of tubes. The tubes were vibrated sinusoidally at 25 cps with an acceleration of $2\frac{1}{2}$ g and were read daily for a total vibration time of 400 hours. It can be seen that the terratex-spaced tubes had much lower vibration output than the mica-spaced tubes over the entire

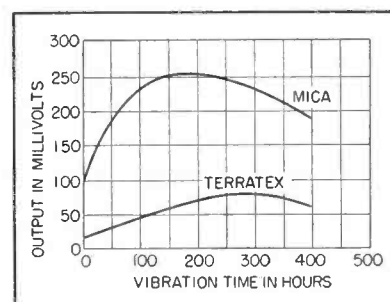



FIG. 3—Tubes employing terratex are less susceptible to microphonics

period of testing. Another particularly interesting characteristic of the material is the high surface roughness, which makes for good interelectrode insulation. Measurements of interelectrode leakage were made over a life-test period of 500 hours, and it was found that the terratex-spaced tubes were considerably superior to the mica-spaced tubes at all testing intervals.

From this brief discussion of the material, it is apparent that there are several advantages associated with the use of terratex. From the standpoint of supply and fabrication, it is possible to obtain strips or sheets of terratex of uniform thickness made from materials available in this country. Further, the material has high thermal and surface resistivities and exhibits certain physical properties which make it appear to be superior to mica in some cases.

It is not known that terratex can be applied successfully as spacer material for all tube types, nor in



L. H. TERPENING COMPANY
 DESIGN • RESEARCH • PRODUCTION
 Microwave Transmission Lines and Associated Components
 16 West 61st St. • New York 23, N. Y. • Circle 6-4760

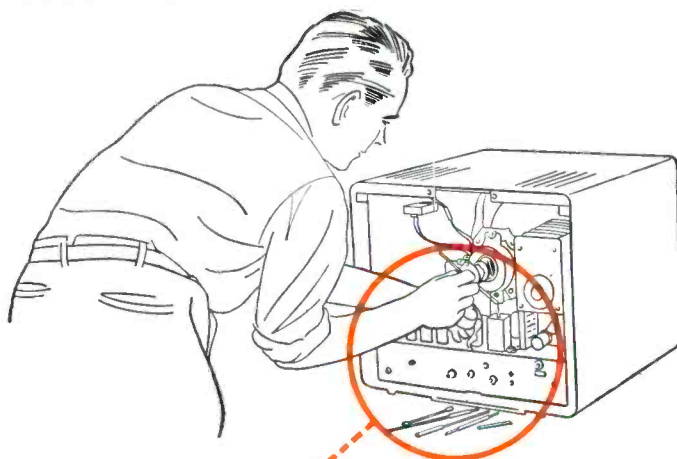

Flexible TV tools of Du Pont nylon plastic

are easy to handle . . .
tough . . . insulated against
high voltage

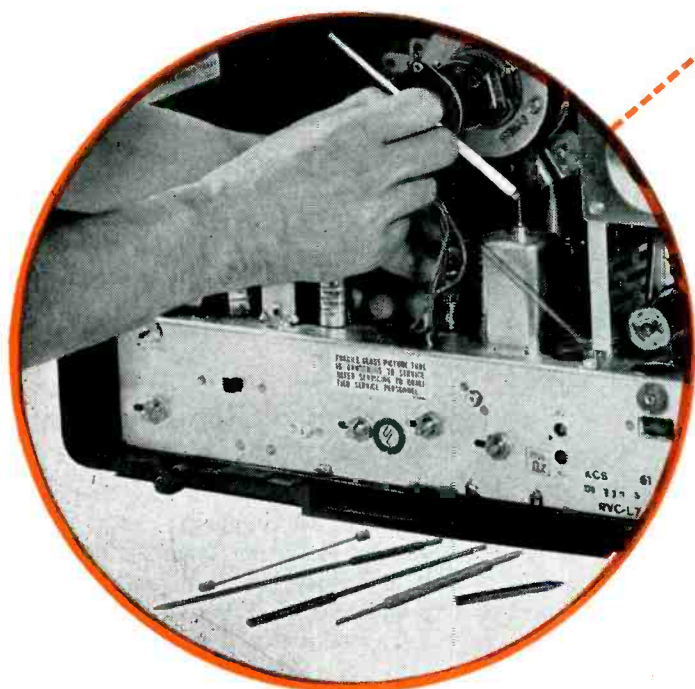

TV aligning tools molded by Teal Molding Co., New Haven, Conn., for JFD Manufacturing Co., Inc., Brooklyn, N. Y.

Aligning the tuning circuit in television sets is a delicate job. It's precision work in hard-to-reach places within the set, working close to high-voltage equipment. These aligning tools made with nylon plastic make the job easier and safer.

Because of the flexibility of Du Pont nylon, the tools can be bent to reach awkward locations. It's tough enough to withstand the abuse that such tools get. And the insulating characteristics of nylon protect service men from shock if the tools contact parts of the set that carry high voltage.

There are many uses in electronics and related fields for the unique combination of dielectric properties and toughness, resiliency and heat-resistance offered by Du Pont nylon. Its properties may well help you improve your product.

Demand for nylon plastic currently exceeds supply. However, we suggest you investigate its properties for future applications. We will gladly discuss the availability of experimental quantities for development work. For additional information on nylon and other Du Pont plastics, write:

E. I. du Pont de Nemours & Company (Inc.)
Polychemicals Department, District Offices:
350 Fifth Avenue, New York 1, New York
7 S. Dearborn St., Chicago 3, Illinois
845 E. 60th St., Los Angeles 1, California



NOW!

3 new ceramic components from C.T.C.



LS-8 SLUG TUNED COIL FORM. Features silver-plated phosphor bronze clip terminals which cannot loosen. Height, 23/32". Maximum diameter, 1/2". Mounts in "D" punched hole or in 1/4" round hole. Coil form is of grade L-5 silicone impregnated ceramic. Slug is provided with a spring lock. All metallic parts except clips are cadmium plated. Supplied complete with slug and all mounting hardware.

X1986 CERAMIC TERMINAL BOARD.

Grade L-5 silicone impregnated ceramic. 35/64" O.A. mounted height including terminals. 1 1/4" length, 7/8" width. Assembly has 8 C.T.C. Type X1558 terminals in 2 rows (4 per row) 9/16" apart, plus two 4-40 tapped standoffs 3/16" high on 5/8" centers. A center ground strap is provided to which standoffs are riveted and soldered for good grounding at R.F. frequencies. All metal parts are non-ferrous, heavily plated.

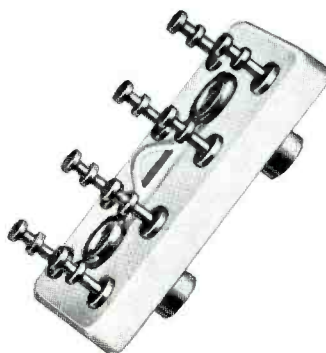

X1990 CERAMIC FEED-THROUGH INSULATOR.

Grade L-5 silicone impregnated ceramic. 7/8" O.A. length including through terminal. 3/8" hex bushing threaded for 1/4" hole mounting. Voltage breakdown 4800 volts R.M.S. @ 60 cycles AC.



SPECIAL CONSULTING SERVICE

A staff of thoroughly experienced C.T.C. component engineers is at your service . . . at no cost to you . . . to help you secure exactly the *right* components for your requirements. They will design special units for you when standard parts are not suitable, working closely with you for economical, satisfactory results.

Feel free to call upon the C.T.C. Consulting Service at any time. Just write direct to Cambridge Thermionic Corporation, 437 Concord Avenue, Cambridge 38, Massachusetts.

custom or standard . . . the guaranteed components

CTC

its present development stage can it be used without decreasing exhaust machine production rates on certain tube types. However, upon the basis of the measurements which have been made on the material and upon the experience obtained in applying the processed terratex to vacuum tubes, it is likely that terratex could be applied to some types of tubes immediately that its several advantages over conventional mica spacers could be realized without sacrificing production rates or tube quality. In order to evaluate the material more fully and to improve it, work is being continued on the project at the G-E Owensboro Development Laboratory. Terratex processed for use in vacuum tube application is not commercially available at this time, although small samples for experimental use may be obtained through the Electronics Department of the General Electric Company.

This article is based on a paper presented by A. P. Haase and E. B. Fehr at the 1951 IRE Convention in New York.

Distributed Resistance Ignition Cable

FOR MANY YEARS it has been the practice to suppress radio frequency radiation from an automobile engine by the addition of resistance in series with the high-voltage ignition circuit. The addition of this resistance quickly damps out the radio-frequency oscillations set up by the discharge of the spark plugs.

The most conventional form of resistor is a separate unit placed in series with the ignition leads either at the spark plug terminal or at the point where the high-voltage coil wire enters the center tower of the distributor. In some cases, resistances are built into the spark plugs. While each car presents a different problem of radio suppression, it is usually found that a 10,000-ohm resistor on the coil to distributor lead is all that is necessary to suppress radio interference to the point where ignition noise does not interfere with reception in the car radio.

With the advent of f-m and tele-



**we'll realize your visions
of design **FOR YOU****

...if electronic components, such as molded coils are your problem

*Other electronic components also
built in quantity
to your most exacting specifications
for stability in service*

JEFFERS
Electronics **INC.**

A SPEER CARBON COMPANY SUBSIDIARY

DU BOIS, PENNSYLVANIA

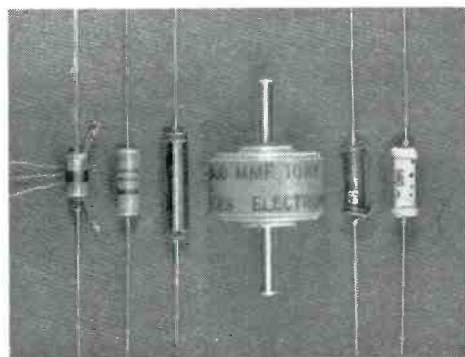

Complete your Circuits with Resistors, Coil Forms and Iron Cores by Speer Resistor Corp., St. Marys, Pa. another SPEER CARBON CO. subsidiary

ELECTRONICS — July, 1951

7862

205

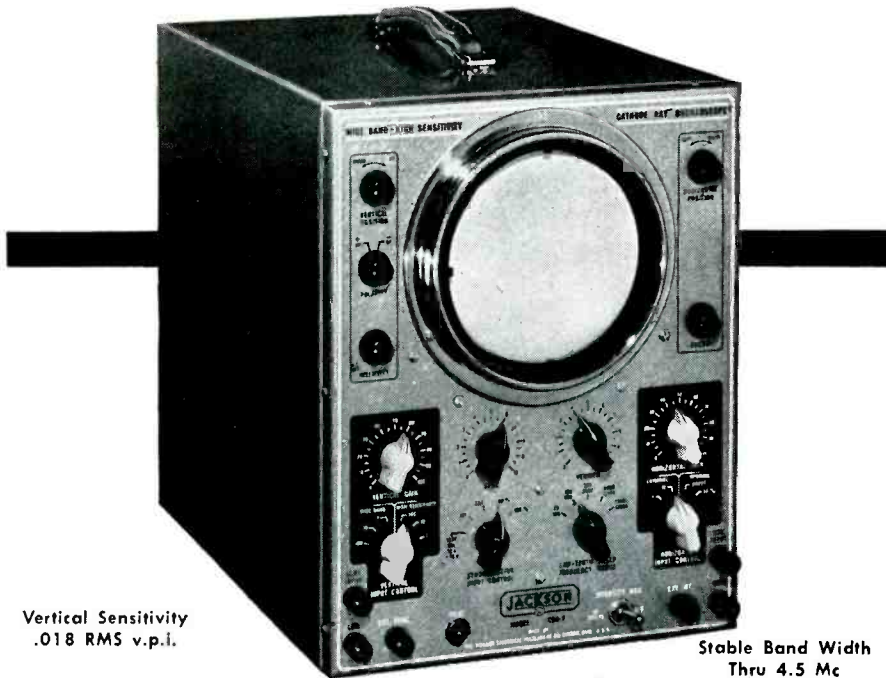

Vertical Sensitivity
.018 RMS v.p.i.

Stable Band Width
Thru 4.5 Mc

JACKSON Oscilloscope gives you "dual service"

This is a high-quality, laboratory-grade 5" Oscilloscope that provides the "dual service" of both high sensitivity and wide band width.

s p e c i f i c a t i o n s

Vertical Amplifier—Video-type frequency compensation provides flat response within 1.5 db from 20 cycles thru 4.5 Mc, dropping smoothly to a still useful value at 6 Mc.

Sensitivity Ranges—With a band width of 20 cycles thru 100 Kc, the sensitivity ranges are .018, 18, 1.8 RMS volts-per-inch. The wide band position 20 cycles thru 4.5 Mc has sensitivity ranges of .25, 2.5, 25 RMS volts-per-inch.

Horizontal Amplifier—Push-pull with sensitivity of 55 RMS volts-per-inch.

Input Impedances—Vertical: 1.5 megohms shunted by 20 mmfd. Direct to plates, balanced 6 megohms shunted by 11 mmfd. Horizontal: 1.1 megohms.

Linear Sweep Oscillator—Saw tooth wave, 20 cycles to 50 Kc in 5 steps. 60 cycle sine wave also available, as well as provision for using external sweep.

Input Voltage Calibration—Provides a standard voltage against which to measure

voltages of signal applied to vertical input.

Vertical Polarity Reversal—For reversing polarity of voltage being checked or for choosing either positive or negative sync. voltages.

Return Trace Blanking—Electronic blanking provides clear, sharp trace to prevent confusion in waveform analysis.

Synchronizing Input Control—To choose among INTERNAL, EXTERNAL, 60 CYCLE, or 120 CYCLE positions.

Intensity Modulation—60 cycle internal or provision for external voltage for intensity modulation uses.

Additional Features—Removable calibration screen—Accessory Model CR-P Demodulation Probe for Signal Tracing—All-steel, gray Ham-R-Tex cabinet. Total net weight only 26 pounds. Same height as other Jackson TV instruments: 13" H x 10 1/4" W x 15 1/8" D.

Prices: Model CRO-2, Users' Net \$197.50.
Model CR-P Probe, Users' Net \$9.95.

TWO OTHER FINE JACKSON INSTRUMENTS

Model 655 Audio Oscillator



Sine-wave 20 cycles to 200,000 cycles. Less than 3% harmonic distortion between 30 cycles and 15,000 cycles. Frequency calibration accurate within 3% or 1 cycle. Hum level down more than 60 db of maximum power output. Output impedances of 10, 250, 500, 5000 ohms or HI Z resistive output.

Model TYG-2 TV Generator



Sweep Oscillator in three ranges from 2 Mc thru 216 Mc, all on fundamentals. Reversible sweep direction. Sweep width variable .1 Mc thru 18 Mc. Marker covers 4 Mc thru 216 Mc. Crystal Oscillator to use as Marker or Calibrator. Video Modulation, from external source for using actual video signal for check, or for use with Audio Oscillator to produce bars for linearity checks.

See your electronics distributor for more information, or write

JACKSON ELECTRICAL INSTRUMENT CO. • DAYTON 2, OHIO
"Service Engineered" Test Equipment
IN CANADA: THE CANADIAN MARCONI CO.

vision, the interference from automobile engines became more serious. Most cars, even those suppressed for ordinary radio, constitute a public nuisance and interfere with reception when operated in close proximity to tv sets.

It has been found by engineers at the Packard Electric Division of General Motor Corporation that the use of suppressor ignition cable having a distributed resistance of approximately 5,000 ohms per foot completely eliminates this objectionable interference. The conductor of this cable consists of multiple threads of high-strength materials, such as linen and rayon, enclosed in a rayon braid. The desired conductivity is imparted to this structure by impregnation with graphite solutions and treatment with special conducting coatings so

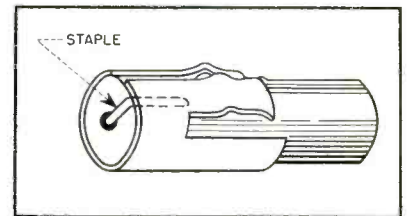

Distributed-resistance cable used in connecting automobile spark plugs reduces f-m and television interference

that cable insulation will properly adhere to the conductor.

Special techniques are employed in attaching terminals to this high resistance conductor. It has been found that a piece of metal wire approximately 1/8 in. long must be inserted in the end of the conductor in order to provide a well-distributed area of contact with the fabric conductor, as shown in the accompanying diagram. An extension of this metal pin is carried across the end of the cable and is firmly contacted by a conventional terminal.

Extensive field and laboratory endurance tests indicate that this method of connection will stand up satisfactorily under even the most rigorous service conditions.

Tests showed the high-resistance cable and the standard neoprene ignition cable tested equivalent on all tests except the voltage breakdown on the new cable is approximately 5 kv less than standard

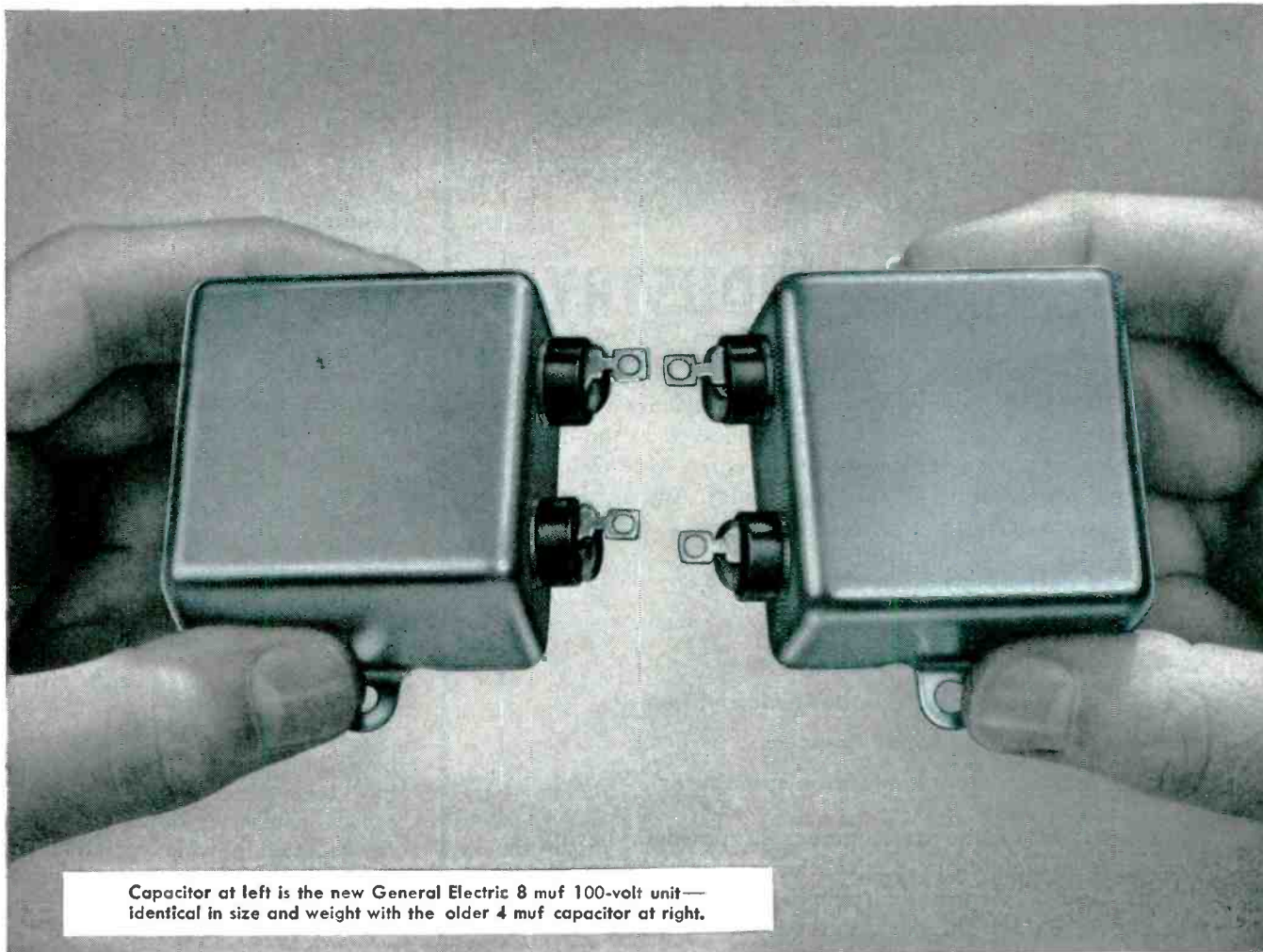

Capacitor at left is the new General Electric 8 muf 100-volt unit—identical in size and weight with the older 4 muf capacitor at right.

8 muf...in the space of 4

New General Electric line of 100-volt d-c capacitors marks another important step in reducing size and weight of electronic equipment.

Here is another outstanding G-E capacitor development—thinner paper, thinner foil, so that double or triple the capacitance can be designed into a cubic inch.

These new capacitors are comparable in all ways with previously offered paper dielectric units, are equally dependable, and in addition are smaller in size and lighter in weight. They will not introduce noises into the system. They will satisfactorily pass signal voltages approaching zero. Their insulation resistance values remain high after long periods of service. While primarily intended for d-c applications with allowable ripple voltages in accordance with JAN-C-25, they will withstand occasional discharges, and can be used in low-voltage a-c circuits.

In Regular Production. Units of 3, 8 and 10 muf in Case Style 53 and 4 muf in Case Style 61 are in regular production. Other ratings can be built in mass-production quantities.

These capacitors meet all requirements of "F" characteristics of JAN-C-25 for 100-volt d-c units. For applications where an expected life of 1000 hours at 40 C is satisfactory, rating can be increased to 150 volts. For ambients above 40 C, units should be derated in accordance with JAN-C-25 Specifications. There is negligible change in capacitance from -40 C to 105 C—and units will give full life at temperatures as low as +55 C.

If you have applications involving reasonable quantities, get in touch with us. Your letter, addressed to Capacitor Sales Division, 42-304, General Electric Company, Pittsfield, Mass. will receive prompt attention.

General Electric Company, Schenectady 5, N. Y.

GENERAL  **ELECTRIC**

407-305

METAL POWDERS

for the

ELECTRONICS INDUSTRY

PLASTIC METALS, with 17 years of experience in the production of metal powders, has pioneered in the development of special property powders for a wide variety of applications in the field of electronics. Among these applications are:

- Permanent magnets
- Permeability tuning cores
- Fly-back transformer cores
- Cathode-ray tube deflection yokes
- Radar and sonar items
- Silicon steel lamination substitutes

In addition to the development of powders having specified magnetic, or electrical characteristics, **PLASTIC METALS** offers iron and nickel powders which are being used by the electronics field in the form of parts made by powder metallurgical methods. The present shortages of steel, nickel, aluminum, zinc, etc. which aggravate the problems of production, or procurement of such things as castings, forgings and die-castings, make it important that you investigate the possibilities of powder metallurgy for:

1. Conservation of critical metals
2. Reduction of manufacturing costs
3. Improvement in product quality
4. Attainment of greater output

PLASTIC METALS invites you to submit your problems that might involve iron, nickel, manganese, silicon or magnetic iron oxide powders. Our Research Staff and 17 years of experience are at your disposal.

For more detailed information, write to



cable, also the capacitance is $5 \mu\text{mf}$ per foot greater. The high resistance cable is satisfactory for automotive ignition.

Logarithmic Counting Rate Meter

By W. F. GOODYEAR
Tracerlab, Inc.
Boston, Massachusetts

COUNTING RATE METERS in conjunction with chart records have found wide application in laboratories where measurements of radioactivity are being conducted. They possess distinct advantages over scaling type instruments in that counting rate can be observed directly without computations and that with a time record inconsistencies in statistical variations can be instantly spotted and either accounted for or disregarded.

If the rate-meter response can be made logarithmic, its utility can be further extended. As an unattended monitoring device it is ideal for measuring wide variations in rate with precisions that are unattainable in a linear instrument without range switching.

Figure 1 shows the front panel of such an instrument designed with the logarithmic response in the circuit itself, permitting the use of conventional panel meters and external linear recorders. The logarithmic element is a thermal diode operating under retarding plate conditions. The operation of such tubes has been described elsewhere,^{1,2,3} and where the leakage resistance can be made sufficiently large, they maintain their logarithmic response over extremely wide ranges of plate current.

In this circuit, intended to operate from the a-c line, heater-to-



FIG. 1—Front view of logarithmic counting rate meter

How do you put **PRECISION** into a potentiometer?...

... At Fairchild we do it by careful design plus scrupulous attention to every phase of manufacture from the selection of raw materials to the precision machining of all mechanical components. Every mechanical part that affects the potentiometer's accuracy is made in our own plant. The result? *Let's find out by examining one of our new 746 units for precision.*

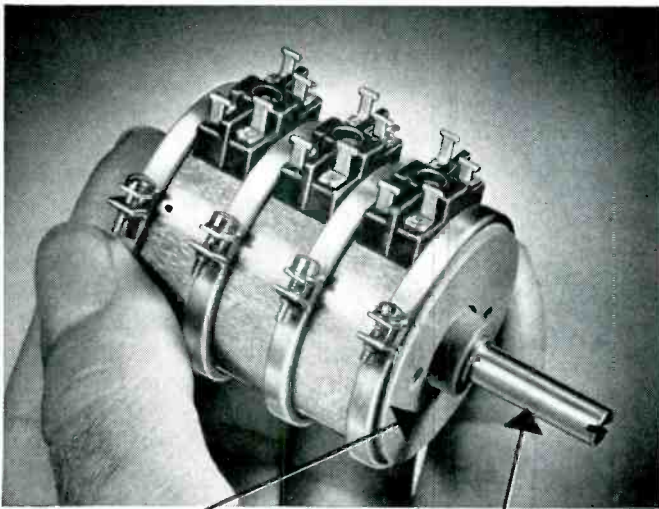

PRECISION in the shaft. The shaft is centerless-ground from stainless steel to a tolerance of $+.0000, -.0002$ in. which, together with the precision-bored bearings, results in radial shaft play of less than $.0009$ in. These accuracies are essential to the utilization of the full precision of the windings and associated gearing.

PRECISION in the mounting plate. All critical surfaces of the mounting plate are accurately machined at one setting to insure a shaft-to-mounting surface squareness within $.001$ in./inch and concentricity of shaft to pilot bushing within $.001$ in. FIR. Such precision is essential in order to eliminate backlash or binding in the precision gearing used to drive these potentiometers.

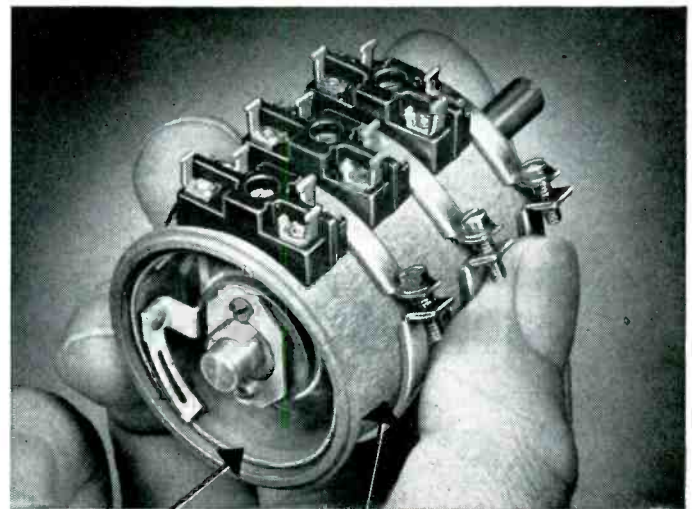

PRECISION in the housing. Precision-machined out of solid aluminum bar stock, every housing is *perfectly cylindrical*—and stays that way—resulting in better accuracy of potentiometer output. This construction also results in perfect fit and alignment between housings to permit ganging of up to 20 units on a single shaft without any eccentricity of the center cups even though only two bearings are used for the entire gang.

PRECISION in the windings. The windings of all Fairchild precision potentiometers are custom-made by an exclusive technique on machines designed and built by Fairchild expressly for the purpose. Guaranteed accuracy of linear windings in this potentiometer is 0.5% ; non-linear, 1.0% . Higher accuracies available in other types. Guaranteed service life—1,000,000 cycles.

Do your requirements call for this kind of precision? If you have a special problem, Fairchild Potentiometer Sample Laboratory engineers are always available to help you. For complete data, write, stating your requirements, to *Fairchild Camera and Instrument Corporation, 88-06 Van Wyck Boulevard, Jamaica 1, N. Y. Dept. 140-17A.*

FAIRCHILD
PRECISION POTENTIOMETERS

Hermetically Sealed

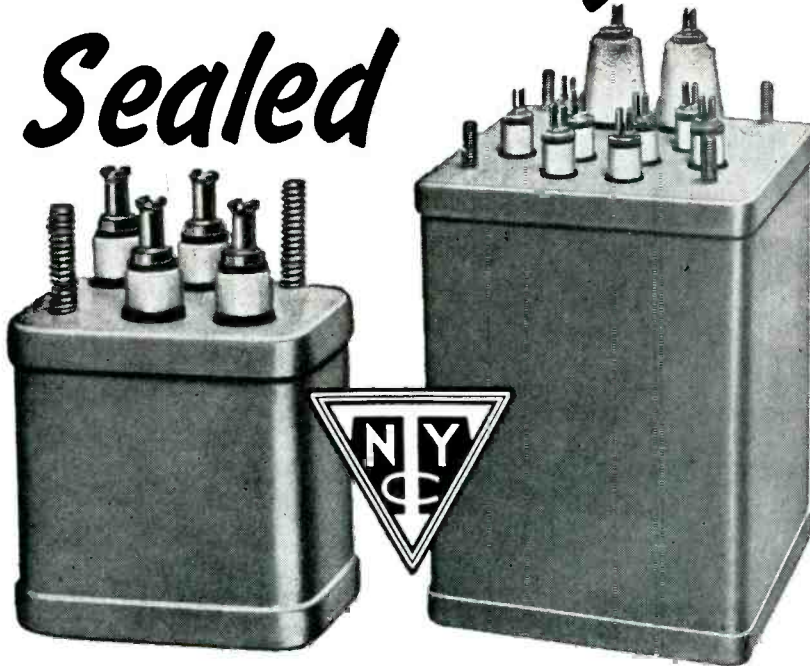

Power — Audio — Plate

TRANSFORMERS

FULL RANGE
of
STANDARD

MIL-T-27
CASES

**Prompt
Delivery**

of
Pre-production samples
to your specifications

**NEW YORK
TRANSFORMER CO., INC.**
ALPHA, NEW JERSEY

cathode leakage was largely the limiting factor at the lowest current ranges. The results of a small portion of a group of unselected 6AL5 diodes operated in this fashion are shown in Fig. 2. The curves are displaced horizontally for clarity in showing consistency of slope. If not displaced, all of the curves would very closely coincide with each other giving a resultant slope of about 200 millivolts per decade of current.

At 10^{-9} amperes, the leakage resistance is just becoming appreciable. Actually the tubes were measured down to 10^{-10} amperes at which point the leakage is up to 100 percent of the signal current. As shown in Fig. 4, the logarithmic diode V_{1A} is operated with its cathode at +105 volts, which, with a 10^{-10} ampere limit on leakage, requires a resistance of at least 10^{12} ohms to ground. Since heater-to-cathode leakage is far in excess of this figure, a special heater transformer was constructed in which the secondary was wound separately and wrapped with Teflon tape before assembly to ensure a high d-c resistance.

At 10^{-4} amperes, five of the six diodes shown in Fig. 2 have a departure from the ideal slope of less than 25 percent. Assuming that the departure is a linear error at both the high and low current limits, it may be predicted that these errors will be less than 2.5 percent for the current range of

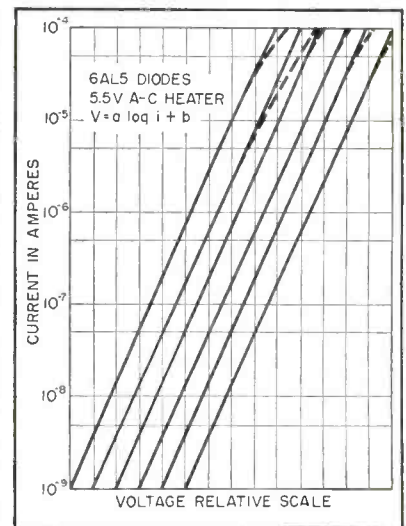
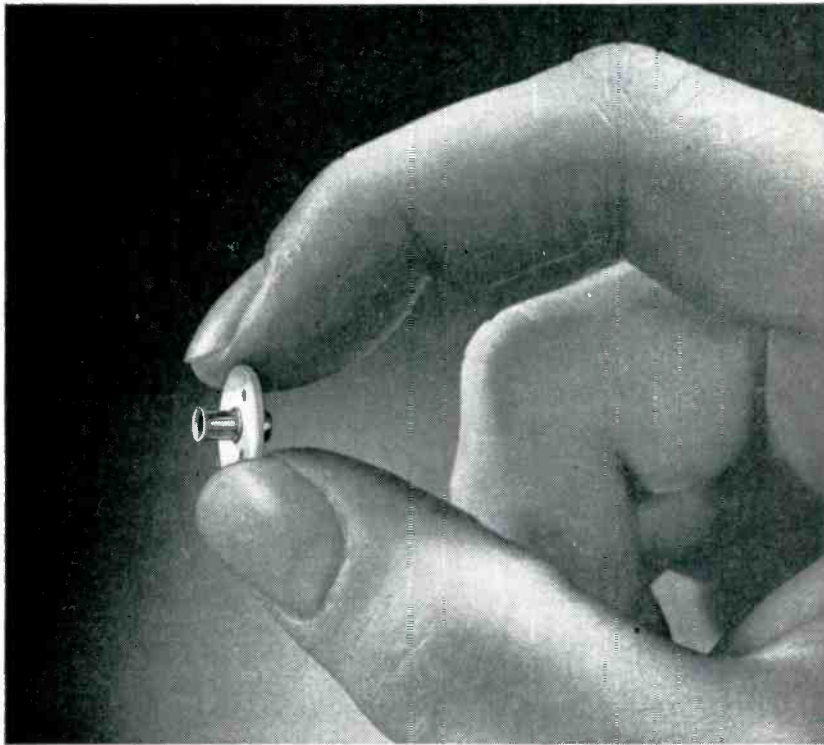
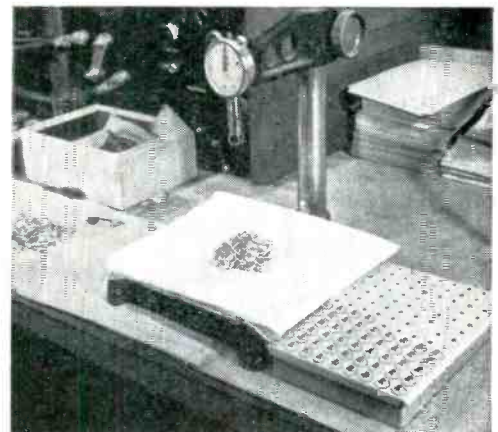

FIG. 2—Results of small sample of random 6AL5 diodes. Curves are displaced horizontally for clarity

Disc Cathode Speeds Assembly- Improves Performance



Expanded Facilities . . . more space, equipment and trained co-workers help to meet growing demand.



Inspection and Gaging . . . equipment for checking "E" dimensions of Disc Cathodes.



52,600 Seamless Nickel Cathodes, compared under a lens with an ordinary pin.

● Electronics manufacturers find it pays to be a customer of Superior. They receive good service, quality products and the benefits of Superior's methods and metals research that constantly improves upon already good products.

An example is the new, improved Disc Cathode. Investigation proved that a slight flaring of the open end minimized the danger of heater cathode "shorts" caused by scraping of the heater wire coating during insertion, while speeding the operation.

This feature added to an already excellent cathode, resulted in a

part that does a better job at a lower cost.

The Disc Cathode is only one of the hundreds of products which Superior supplies . . . but the same program of product improvement is applied to all of them. That's why most manufacturers in the electronics field are already friends and customers. If you are one of the exceptions, it will pay you to find out more about Superior and Superior products. For information, consultation about production problems, design help or research assistance, write today to Superior Tube Company, 2500 Germantown Ave., Norristown, Pennsylvania.

Which Is The Better For Your Application . . .

SEAMLESS . . . ? The finest tubes that can be made. Standard production is .010" to .121" O.D. inclusive, with wall thicknesses of .0015" to .005". Cathodes with larger diameters and heavier walls will be produced to customer specification.

Or LOCKSEAM* . . . ? Produced directly from thin nickel alloy strip stock, .040" to .100" O.D. in standard length range of 11.5 mm to 42 mm. Round, rectangular or oval, cut to specified lengths, beaded or plain.

Superior
THE BEST IN SMALL TUBING

All analyses .010" to 1/2" O.D.
Certain analyses (.035" max. wall) Up to 1 1/2" O.D.

*Mfd. under U.S. Pats.—Superior Tube Company • Electronic Products for export through Driver-Harris Company, Harrison, New Jersey • Harrison 6-4800

DO YOU NEED New and Different

SPRINGS, COILS or WIREFORMS?

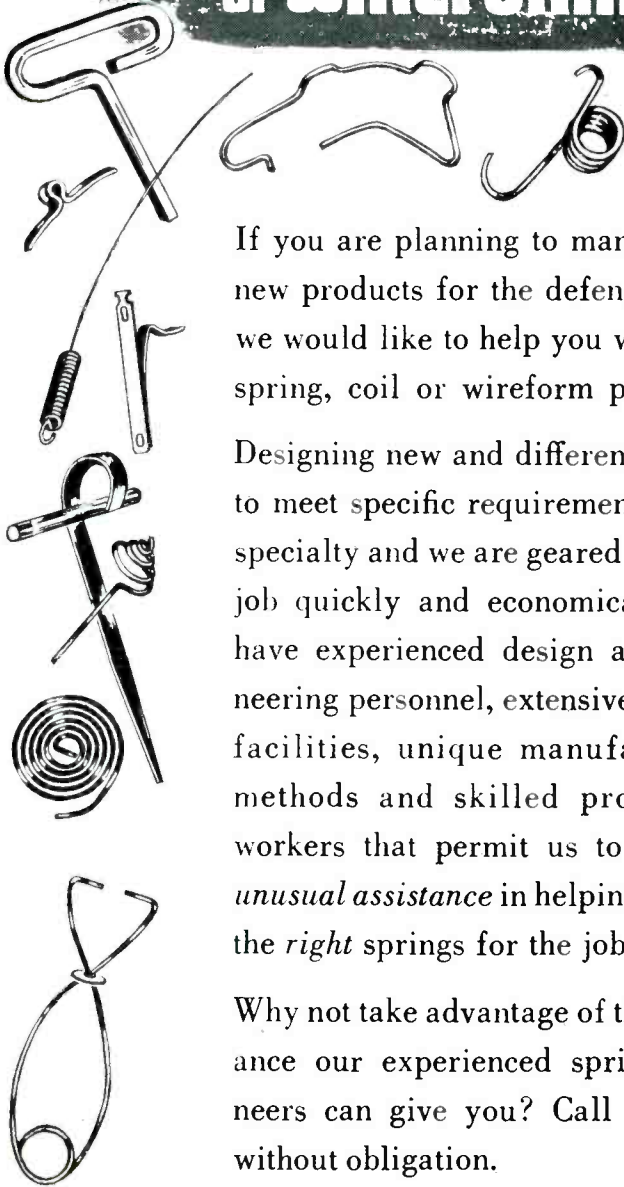

If you are planning to manufacture new products for the defense effort, we would like to help you with your spring, coil or wireform problems.

Designing new and different springs to meet specific requirements is our specialty and we are geared to do the job quickly and economically. We have experienced design and engineering personnel, extensive modern facilities, unique manufacturing methods and skilled production workers that permit us to provide *unusual assistance* in helping you get the *right* springs for the job.

Why not take advantage of the assistance our experienced spring engineers can give you? Call or write without obligation.

LEWIS SPRING & MANUFACTURING CO.
2656 West North Avenue, Chicago 47, Ill.

Lewis  **PRECISION SPRINGS**
THE FINEST LIGHT SPRINGS AND WIREFORMS OF EVERY TYPE AND MATERIAL

10^{-6} to 10^{-8} amperes. Subsequent tests have verified this and later tests on the Raytheon CK5829 sub-miniature equivalent of the 6AL5 have indicated this type is even more consistent and more linear at the higher currents, permitting errors of less than 1 percent for the range just mentioned.

With this accuracy over three decades, a Brown type potentiometer recorder with its wide chart was selected to enable an operator to utilize fully the inherent instrument accuracy. For the same reason a panel meter with a 270-degree movement was selected for operation in the absence of a recorder.

The counting rate range was chosen to be from 1 count per second to 1,000 counts per second for the three most useful decades of operation. Conversion of counting rate to average diode current was accomplished in a circuit shown simplified in Fig. 3.

The switch is closed for a fixed duration t for each individual impulse. A large capacitor shunts the diode to keep its average voltage from changing to any extent during individual impulses so that on a peak, current E/R flows for each input signal if E is much larger than the diode voltage. From this the average current can be readily calculated.

The diode response has been given as

$$V = \frac{KT}{e} \log i + b \quad (1)$$

where K is Boltzmann's constant, e is the electronic charge, and T is the cathode temperature in de-

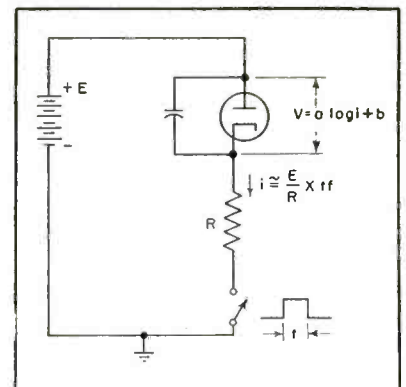
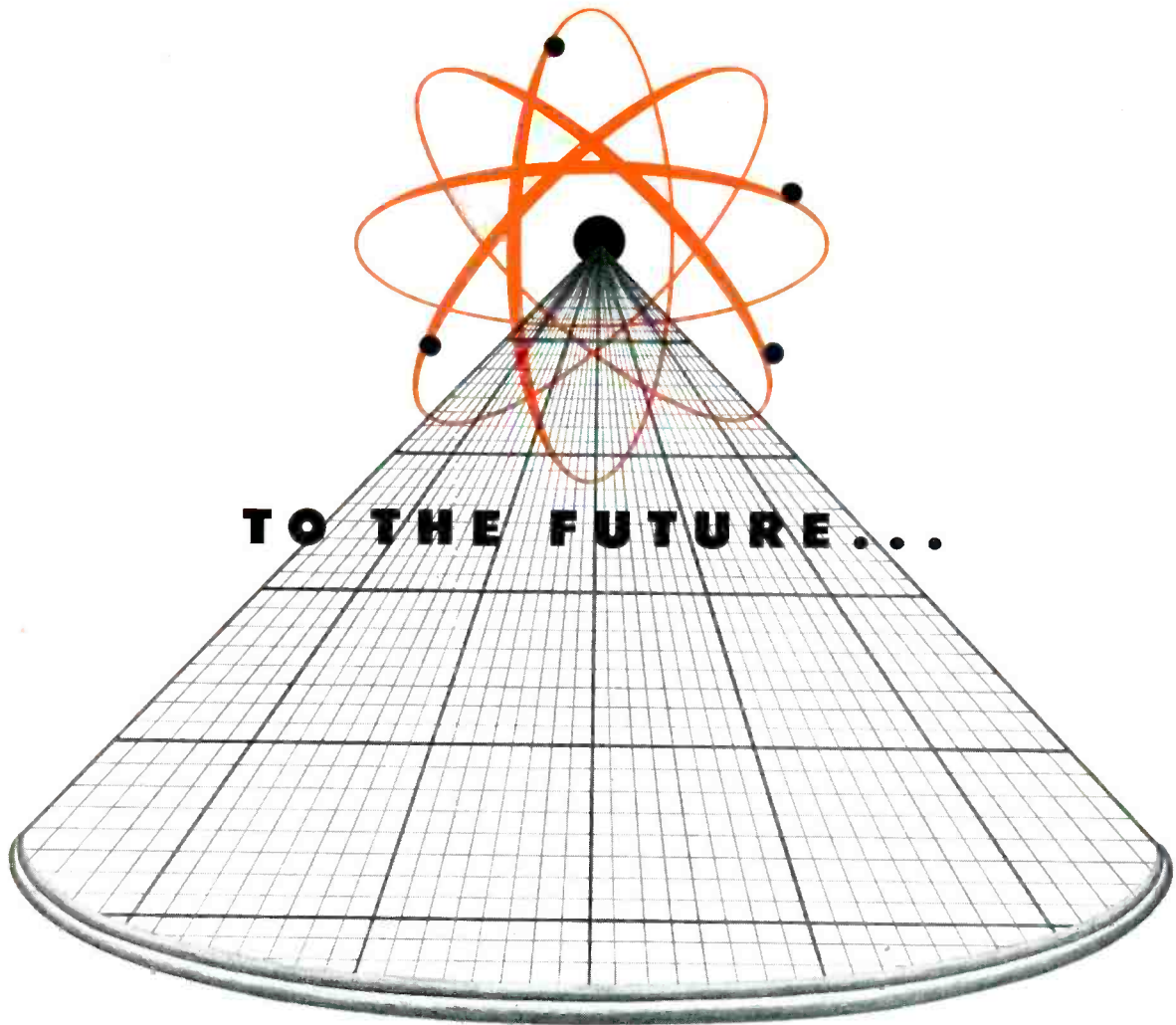

FIG. 3—Basic circuit for converting counting rate to average diode current



TO THE FUTURE...

ELECTRONIC RESEARCH AND DEVELOPMENT

Long before the present rearmament program, our Electronics Division was engaged in research, development, and production for the United States and foreign governments. Air Associates is established as a major supplier of: LF, VHF and UHF communication and navigation systems, landing systems, firing-error indicator systems, echo-ranging systems (including sonar), and special miniaturized electronic devices. Whether your requirements are immediate or for the future, our diversified experience can help in solving airborne, marine and ground electronic problems. Your inquiry to Teterboro will receive prompt reply.

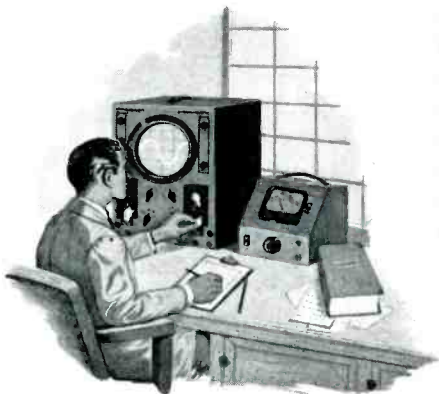

Air Associates
INCORPORATED
TETERBORO, NEW JERSEY



SERVING THE NATION IN AVIATION

WORKSHOP

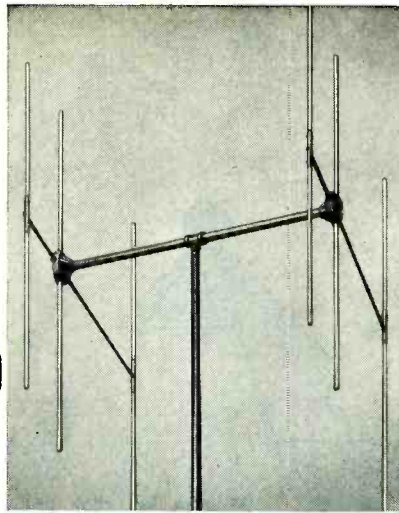

DIRECTIONAL ANTENNAS

Workshop directional (and bi-directional) antennas are designed expressly for point-to-point communications, particularly — railway, highway patrol, public safety, police, utility, pipe lines, forestry, and other similar uses. Their high gain and sharp directivity provide strong, clear reception and long-range coverage at minimum cost. Rugged, heavy-gauge aluminum elements and enameled steel supports guarantee long, dependable service with no maintenance expense. Installation is very simple, requiring only an iron pipe mast and cable. Ten different models are available, one for each operating band.

GAIN — Conservatively rated at 7.6 db. over a 1/2-wave dipole; 15.2 db. for system when used in pairs — one at each end of circuit

RUGGED CONSTRUCTION — Withstands steady 65 mph wind with 1/2" radial ice; 85-90 mph without ice with adequate safety factor

1/2-POWER ANGLES — 64° Horizontal, 68° Vertical

FRONT-TO-BACK RATIO — 20 db., measured

VSWR — Less than 1.5:1

IMPEDANCE — 52 ohms

VERTICAL POLARIZATION — Horizontal on request

MOUNTING — 1 1/2" standard threaded pipe

ENGINEERING and CONTRACT SERVICE. The WORKSHOP handles scores of special government and commercial antenna problems every year from design through production. If your product or service requires high-frequency antennas — research, design, or production — get in touch with the WORKSHOP. Write, or phone Needham 3-0005. No obligation.

The WORKSHOP ASSOCIATES, Inc.

Specialists in High Frequency Antennas

135 Crescent Road, Needham Heights 94, Massachusetts

OTHER WORKSHOP ANTENNAS

Aeronautical Ground Station
For aircraft communications — omnidirectional.

Parabolic Antennas
For radio, microwave, STL and TV relay and communications.

Beacon
For fire, police, taxi-cab, and private fleet communications.

TV, FM and Amateur

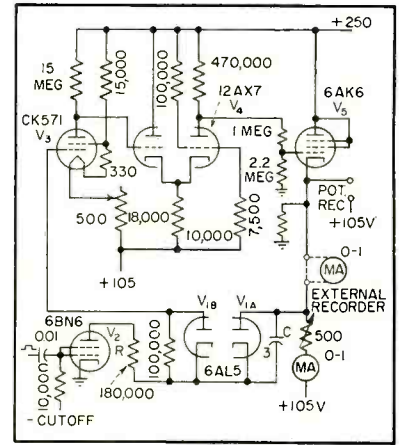

FIG. 4—Complete schematic of logarithmic counting rate meter

grees Kelvin. Differentiating,

$$\frac{dV}{di} = \frac{KT/e}{i} \quad (2)$$

which for conventionally operated oxide coated cathodes becomes simply

$$\frac{dV}{di} = \frac{0.1}{i}$$

This is recognizable as the dynamic resistance of the diode and indicates that the resistance will vary inversely with counting rate.

This resistance in parallel with the tank capacitor forms the circuit time constant

$$RC = \frac{0.1C}{i}$$

Unlike a conventional ratemeter, the time constant is not fixed but varies with counting rate. Since the fractional error in counting rate at any given instant is

$$E = 0.67 \frac{1}{\sqrt{2nRC}} \quad (4)$$

where n is the number of pulses in the time RC , the fractional error in this type of circuit tends to remain constant for a wide range of actual counting rates. Also, because of the progressive resistance change this logarithmic circuit will respond more quickly to large changes in counting rate and reach equilibrium faster than a linear circuit with the same time constant for the initial rates.

Figure 4 shows the voltmeter and charging circuits designed for this circuit. The 6BN6 (V_2) is used as the switching device in series with the current limiting resistor and the diode. Stringent demands

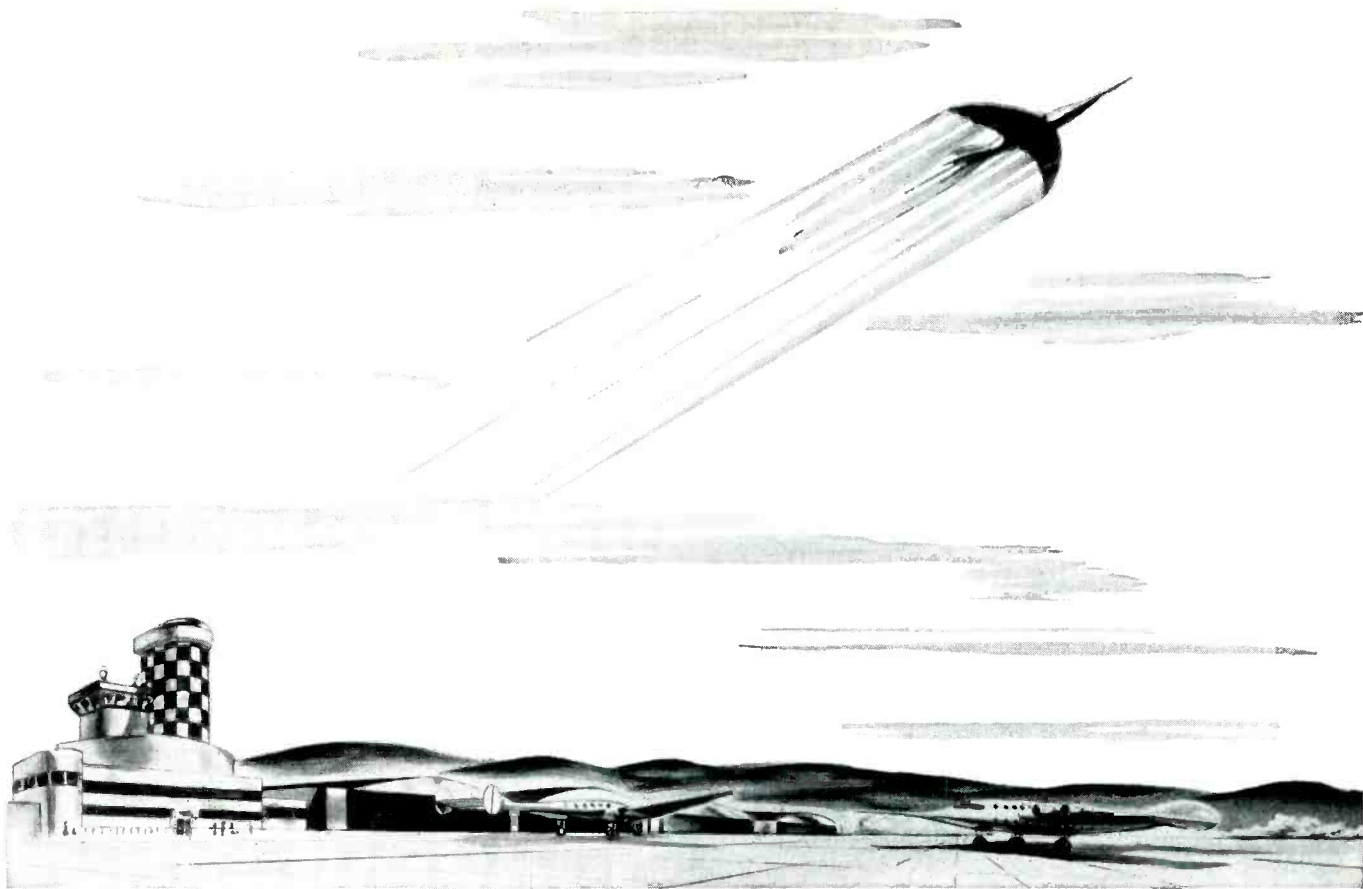

from sea level to substratosphere . . .

VARGLAS SILICONE

Electrical Insulating Tubing and Sleeving

WITHSTANDS TEMPERATURES FROM 500° TO -85°F

VARGLAS SILICONE is a high dielectric, dimensionally stable insulating material developed by Varflex during World War II to assure dependable performance in the drastic temperatures aircraft might encounter from sea level to substratosphere. Today, Varglas Silicone

serves industry in many of the tough insulating jobs that defeat ordinary insulators. A combination of *Varglas* (continuous filament Fiberglas) and *Silicone High Temperature Resin*, Varglas Silicone is the first and only Class H insulation with these features:

EFFICIENT AT 500°F. — flexible at -85°F.

MOISTURE AND FUNGUS-RESISTANT — has excellent resistance to moisture and fungus.

FIRE-RESISTANT — flame resistant and self-extinguishing.

ABRASION-RESISTANT — pliable and non-fraying.

DIELECTRICALLY STRONG — average readings up to 7,000 volts.

Available in various NEMA colors in several types and grades of tubing and sleeving — lead wire and tying cord, too.

Varflex
CORPORATION

*Makers of
Electrical Insulating
Tubing and Sleeving*

VARFLEX Sales Co., Inc.
308 N. Jay St., Rome, N. Y.

**Every DESIGN, PRODUCTION
AND PURCHASING DEPARTMENT
should have a copy**

CATALOG T-51
1951 Edition

S.S. White
PRODUCTS
for
INDUSTRY

CATALOG T-51 is a brand new 52-page catalog which contains complete descriptions and prices on —

- Flexible shaft arms and accessories
- Points, wheels, disks, burs and drills for flexible shaft tools
- Standard flexible shaft combinations for power drives and remote controls
- Flexible shaft adapters, pressure bulkhead fittings, actuators
- Molded resistors
- Plastic shipping plugs and caps
- Inspection mirrors, engine belts, gypsum products, industrial cements, bench lathe, blowpipe

Free copies sent on request. Write today.

**THE *S.S. White* INDUSTRIAL DIVISION
DENTAL MFG. CO.**



DEPT. E, 10 EAST 40th ST.
NEW YORK 16, N. Y.

WESTERN DISTRICT OFFICE: Times Bldg., Long Beach, Calif.

are placed on this switching tube. During conduction, the tube must pass peak currents of about 10^{-8} amperes, yet between conducting intervals its plate current due to all causes including leakage must be less than 10^{-10} amperes to permit 1 percent accuracy at 10^{-8} amp diode current. Many tube types were tested for this application with the final selection being the recently announced beam type 6BN6 designed as an f-m discriminator-limiter. The full conduction current is relatively independent of control pulse amplitude and its leakage current is considerably better than the 10^{-10} amperes required. In fact this tube's performance under these somewhat unique conditions is far superior and far more consistent than with any other conventional type tested.

Voltmeter Circuit

The voltmeter circuit is of the feedback amplifier type consisting of V_3 , V_4 and V_5 . The grid of V_3 sees the sum of the diode voltage, applied through V_{1B} in series with the feedback voltage developed across the sensitivity control and milliammeter. As a result the voltage from the cathode of the logarithmic diode to ground is maintained nearly constant and since the feedback voltage must nearly equal the signal voltage, the current required to supply the feedback voltage depends on the amount of resistance in the sensitivity control. An external recording milliammeter can be also connected in the feedback loop since current is supplied, or a potentiometer type recorder can read the feedback voltage.

Tube V_3 is an electrometer-type tube with its d-c heater operated from the regulated B supply voltage. The zero control is in the heater circuit and operates by changing the relative grid bias. Tube V_{1B} is the unused section of the logarithmic diode and is connected to help buck out the effects of line voltage changes on V_{1A} .

Despite this latter precaution, for low long-term drifts, it is also necessary to regulate the line voltage supply to the instrument. Likewise, B supply regulation is essential.

Calibration of this type instru-

**The FIRST all-band
direct reading**

SPECTRUM ANALYZER

10 MCS to 16,520 MCS

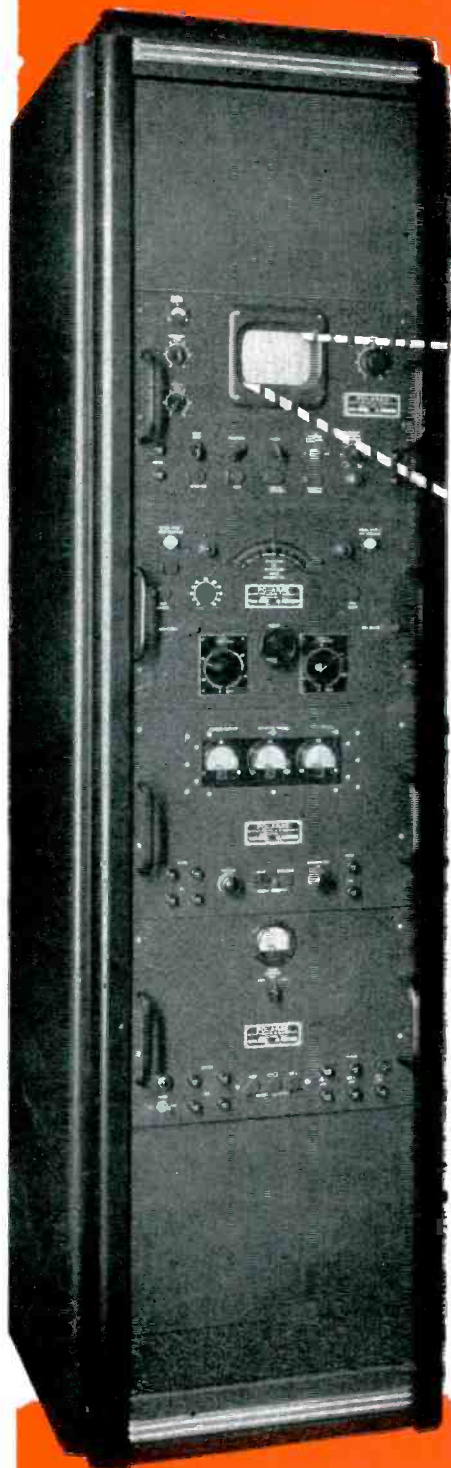

Polarad's Model LSA Spectrum Analyzer is the result of years of research and development. It provides a simple and direct means of rapid and accurate measurement and spectral display of an r.f. signal.

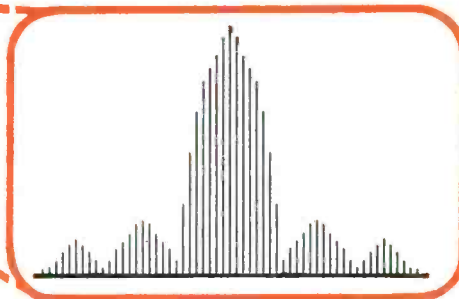

Outstanding Features:

- Continuous tuning.
- One tuning control.
- 5 KC resolution at all frequencies.
- 250 KC to 25 MCS display at all frequencies.
- Tuning dial frequency accuracy 1 percent.
- No Klystron modes to set.
- Broadband attenuators supplied with equipment above 1000 MCS.
- Frequency marker for measuring frequency differences 0-25 MCS.
- Only three tuning units required to cover entire range.
- Microwave components used latest design non-contacting shorts for long mechanical life.
- Maximum frequency coverage per dollar invested.
- 5 inch CRT display.

Where Used:

Polarad's Model LSA Spectrum Analyzer is a laboratory instrument used to provide a visual indication of the frequency of distribution of energy in an r.f. signal in the range 10 to 16,520 MCS.

Other uses are:

- 1 Observe and measure sidebands associated with amplitude and frequency modulated signals.
- 2 Determine the presence and accurately

measure the frequency of radio and/or radar signals.

3. Check the spectrum of magnetron oscillators.
4. Measures noise spectra.
5. Check and observe tracking of r.f. components of a radar system.
5. Check two r.f. signals differing by a small frequency separation.

Write Dept. E-7 for Complete Details

*the instrument consists of
the following units:*

Model LTU-1 R.F. Tuning Unit—10 to 1000 MCS.
Model LTU-2 R.F. Tuning Unit—940 to 4500 MCS.
Model LTU-3 R.F. Tuning Unit—4-60 to 16,520 MCS.
Model LDU-1 Spectrum Display Unit.
Model LPU-1 Power Unit.
Model KLU-1 Klystron Power Unit.

Polarad

Electronics Corporation

100 Metropolitan Ave. Brooklyn 11, N. Y.

Manufacturers of broadband microwave laboratory instruments.

RAYTHEON

MAGNETIC COMPONENTS FOR MILITARY APPLICATIONS

Raytheon Voltage Stabilizers, Transformers and other Magnetic Components are noted for reliability in the most exacting military service. As a leading manufacturer for 20 years, Raytheon has developed engineering and production facilities which enable it to produce highest quality components to meet the most rigid MIL requirements. Write for complete information.



VOLTAGE STABILIZERS

Precision built to provide maximum voltage stabilization with minimum variation in output voltage. An essential component for all electronic or electrical equipment requiring constant voltage for dependable, accurate operation. Available in catalog models from 15 to 2000 watts output capacity . . . or custom-engineered to suit special applications.

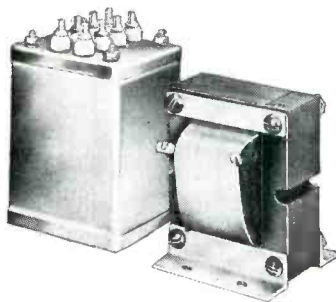

CUSTOM-BUILT TRANSFORMERS

Individually engineered to meet the most exacting military or commercial requirements. Typical units include: single or polyphase power transformers, pulse transformers, servo transformers, chokes, saturable magnetic components, etc. Cased or open types to meet MIL specifications as well as Underwriters' Laboratories and R. M. A. requirements.

Write for Complete Information

Raytheon Products include: Mariners Pathfinder* radar; Fathometers*; radio and television receivers; tubes; microwave communications; electrostatic air cleaners; Weldpower* welders; voltage stabilizers; Recticharger* battery chargers; Rectifilter* battery eliminators; Rectringers*; transformers; Microtherm* diathermy; fractional hp motors, and other electronic equipment.*®

Magnetic Components Division, Dept. 6460-A
RAYTHEON MANUFACTURING COMPANY
Waltham 54, Massachusetts

ment is difficult without two accurately known rates spaced far enough apart to adequately define the slope. In this case a decade scale of ten was employed to divide the line frequency to the input pulse forming circuits preceding the charging tube. Sixty cycles was used directly for the other calibration point. The plug-in decade scale can be seen in Fig. 5. It is also used to divide the signal rate if desirable, shifting the 1 to 1,000 count per second range by a factor of 10. Figure 5 also shows the large tank capacitor mounted

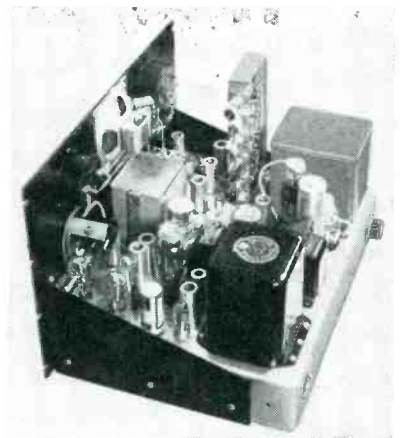

FIG. 5—Rear view of unit shows plug-in decade unit and large tank capacitor (directly behind speaker)

directly beneath the speaker. It is the polystyrene dielectric type and is used to minimize hysteresis effects due to dielectric absorption and because of its high leakage resistance.

The remaining circuitry is fairly conventional. A regulated high-voltage supply is provided for Geiger counters or similar-type radiation detectors. The output of the detector is amplified and shaped to give constant width pulses in the input circuits. An aural monitor has also been included to give a rough indication of counting rate at very low levels.

REFERENCES

- (1) R. E. Meagher and E. P. Bentley, *Rev. Sci. Inst.*, Nov. 1939.
- (2) T. S. Gray and H. B. Frey, *Rev. Sci. Inst.*, Feb. 1951.
- (3) "Waveforms," Vol. 19, *Rad. Lab. Series*, p 61, McGraw-Hill Book Co., Inc., New York.
- (4) W. C. Elmore and M. Sands, "Electronic Techniques," p 252, *National Nuclear Energy Series*.

The Ideal Dielectric

FOR NEW **UHF-TV** APPLICATIONS

MYCALEX

Glass-Bonded Mica
INSULATION

**- for low loss
at low cost!**

- LOW-LOSS FROM 60 CYCLES/SECOND TO 24,000 MEGACYCLES/SECOND
- MAXIMUM EFFICIENCY, UTMOST ADAPTABILITY, LOWEST COST
- AVAILABLE MOLDED TO PRACTICALLY ANY SHAPE OR SIZE WITH OR WITHOUT METAL ELECTRODES OR INSERTS

FCC Approval of UHF TV has introduced an era of engineering and manufacture to standards seldom before attained in mass production. Many materials, dielectrics in particular, fail to meet these more critical requirements. MYCALEX 410 is one exception. This dielectric can be molded to close tolerances with or without metal inserts—high efficiency to well over 24,000 megacycles. MYCALEX 410 can be molded in volume at low cost. It can be produced to closer tolerances than higher priced ceramics. Electrically and mechanically, MYCALEX 410 is the ideal dielectric for tube sockets, tuners, condensers, switches, coil structures and many other UHF components.

CHARACTERISTICS OF MYCALEX GRADE 410

Power factor, 1 megacycle	0.0015
Dielectric constant, 1 megacycle	9.2
Loss factor, 1 megacycle	0.014
Dielectric strength, volts/mil	400
Volume resistivity, ohm-cm	1×10^{15}
Arc resistance, seconds	250
Impact strength, Izod, ft.-lb./in. of notch	0.7
Maximum safe operating temperature, °C	350
Maximum safe operating temperature, °F	650
Water absorption % in 24 hours	nil
Coefficient of linear expansion, °C	11×10^{-6}
Tensile strength, psi	6000

WRITE FOR 20-PAGE CATALOG

This comprehensive compilation of technical and manufacturing data includes complete dielectric information.

TUBE SOCKETS

MYCALEX glass-bonded mica sockets are injection molded to extremely close tolerance. This exclusive process affords superior low-loss properties, exceptional uniformity and results in a socket of comparable quality but greater dimensional accuracy than ceramics—all at no greater cost than inferior phenolic types. These sockets are available in two grades, featuring high dielectric strength, low dielectric loss, high arc resistance and fully meet RTMA standards.

Write for Tube Socket Data Sheets

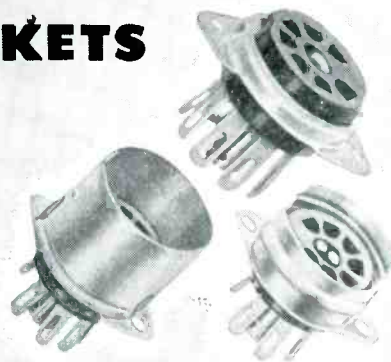

MYCALEX 410 is priced comparable to mica-filled phenolics. Loss factor is only .015 1 mc., insulation resistance 10,000 megohms. Fully approved as Grade L-4B under N.M.E.S. JAN-1-10 "Insulating Materials Ceramic, Radio, Class L."

MYCALEX 410X is low in cost but insulating properties greatly exceed those of general purpose phenolics. Loss factor is only one-fourth that of phenolics (.083 at 1 mc.) but cost is comparable. Insulation resistance 10,000 megohms.



MYCALEX CORPORATION OF AMERICA

Owners of 'MYCALEX' Patents and Trade-Marks

Executive Offices: 30 ROCKEFELLER PLAZA, NEW YORK 20 — Plant & General Offices: CLIFTON, N.J.



the **NEW** S-8 Oscillograph

Here, in a versatile instrument of advanced design, are all the things you need for complete oscillographic recording. The Hathaway Type S-8 Oscillograph, which has long been the standard of oscillographic recording, has been improved to meet the rapidly expanding demands of modern research. Whether your measurement problems are simple or complex, the NEW Type S-8 Oscillograph has the inherent capabilities necessary to measure vibration, pressure, acceleration, and strain with new ease and accuracy.

The newest features include:

QUICK-CHANGE TRANSMISSION fully enclosed with gears running in oil to provide instantaneous selection of 16 record speeds over the range of 120:1

CHART TRAVEL INDICATOR provides continuous indication of chart motion. Operator knows instantly by flashing lamp if anything should happen to interfere with chart motion

FULL-RESILIENT MOUNTING FOR MOTOR AND TRANSMISSION isolates all possible vibration and makes possible the use of modern super-sensitive galvanometers

NEW GALVANOMETER STAGE accommodates all Hathaway galvanometer for recording milliamperes, microamperes, or watts

NEW RECORD-LENGTH CONTROL AND NUMBERING SYSTEM designed for long, trouble-free service under all kinds of ambient conditions

All the other valuable features are retained, such as **PRECISION TUNING-FORK-CONTROLLED TIMING SYSTEM** produces either 1/10-second or 1/100-second time lines across sheet

WIDE RANGE OF GALVANOMETER TYPES AND CHARACTERISTICS provide for almost any recording requirements. Natural frequencies to 10,000 cps. Sensitivities to 50,000 mm per ma, single and polyphase watts

DAYLIGHT LOADING AND UNLOADING RECORDS TO 200 FT. IN LENGTH, width to 10 inches

SIMULTANEOUS VIEWING AND RECORDING

AUTOMATIC BRILLIANCY CONTROL

12 TO 92 ELEMENTS

Whatever your needs may be, investigate the NEW Type S-8 Oscillograph and its 170 types of galvanometers — the most versatile equipment in existence for general-purpose applications.

WRITE FOR BULLETIN 2B1-A-G

Hathaway 
INSTRUMENT COMPANY.
 1315 SO. CLARKSON STREET • DENVER 10, COLORADO

NEW PRODUCTS

(continued from page 144)

study of transient and steady state vibrations and noise in many engineering and scientific fields. It is useful in measurements on aircraft, ships, rotating and reciprocating machinery and in the fields of ordnance, ballistics, seismology and acoustics; and also may be used for l-f underwater studies. With the new instrument one can obtain Fournier analyses of signals in the 5 to 4,400-cps range by a direct-writing process. Power supply is 115 volts, 60 cps; price, \$2,500.

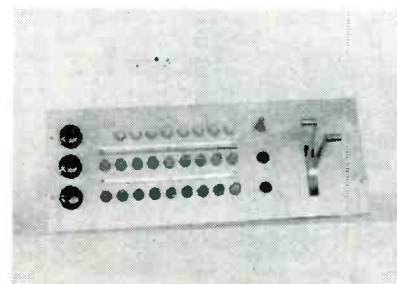

TV Montage Amplifier

GENERAL ELECTRIC Co., Syracuse, N. Y. Type TV-35-B television montage amplifier permits vertical, horizontal and wedge wipes, and preset superpositions. The unit and its control panel (Type TC-34-A) allow two-signal self-keyed or three signal keyed insertions of sponsors' products or advertising material. They are fast acting, allowing sharp clear keying of irregularly shaped areas. To assure proper positioning and picture composition, a locating signal may be fed to the studio camera viewfinder. Horizontal, vertical and wedge-wipe action may be stopped at any point.

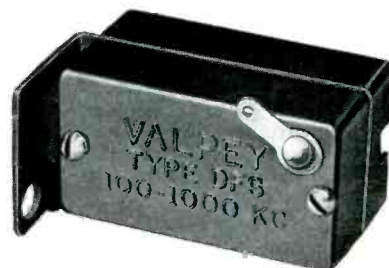

Dual Frequency Standard

VALPEY CRYSTAL CORP., Highland St., Holliston, Mass. Type DFS

ONE OF A LINE...

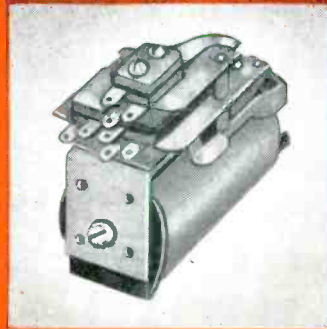

SERIES 695 D.C.



A.N. CONNECTOR PLUG
HERMETIC SEALED CONTAINER

**APPROVED BY THE
SIGNAL CORPS**
FOR
Dependable Control

In peace as in war—men of the Signal Corps recognize the Guardian 695 D. C. Relay as a dependable component of *finest precision* communications equipment. Field telephone sets—walkie talkies—ground to plane—interplane—intraplane—ship to shore radios, all operate perfectly under severest conditions using this tiny relay, either *hermetically sealed* or with open mounting.

Special design of the Guardian 695 D. C. Relay provides an unusually long coil without increasing the overall length of complete unit. Correct balance of copper winding and volume of iron on field piece result in maximum flux density without oversaturation of iron. Up to 6 S.P.S.T. contact combinations. Available with standard open mounting or hermetically sealed in Lug Header type housing and to specifications in A. N. Connector, Screw Terminal or Octal Plug housings.

**GUARDIAN
RELAYS**



GUARDIAN'S NEW HERMETICALLY SEALED RELAY CATALOG IS YOURS FOR THE ASKING

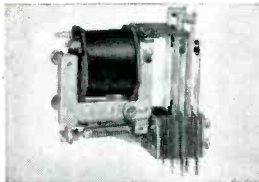

Series 30 A.C.

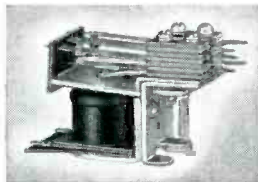

Series 210 A.C.—215 D.C.

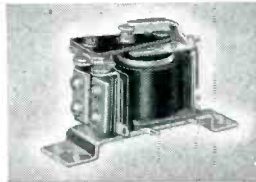

Series 220 A.C.

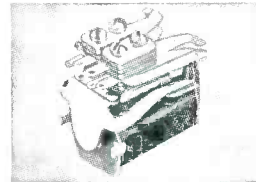

Series 595 D.C.

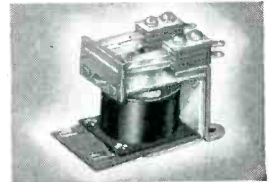

Series 610 A.C.—615 D.C.

SUBMIT YOUR B/P SPECIFICATIONS FOR SPECIAL RECOMMENDATIONS—WRITE

GUARDIAN  **ELECTRIC**
1625-H W. WALNUT STREET CHICAGO 12, ILLINOIS
A COMPLETE LINE OF RELAYS SERVING AMERICAN INDUSTRY

A Revolutionary Development!

LORD Shipping Mounts

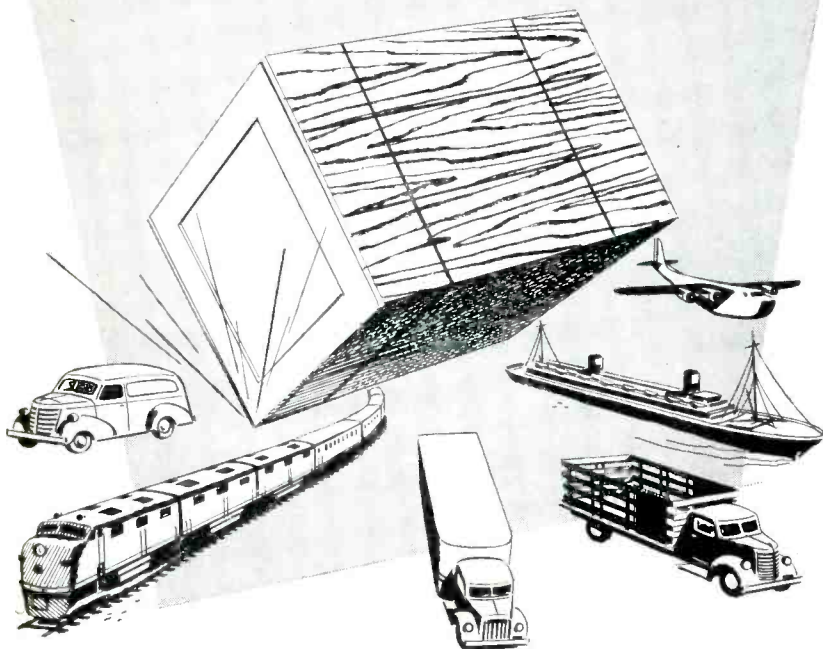

Provide New Safety for Shipments

Lord Shockproof Packing does away with solid bolting, cushion packing, and all other methods heretofore used in the attempt to safeguard the shipment of fragile products, sensitive equipment, and complicated mechanisms.

The product rides on Lord Shipping Mounts, designed to cushion the forces of shock in transit. Even under severe abuse in handling the product never touches the container.

From the knowledge and experience gained in over a quarter of a century of specialization in solving shock and vibration problems, Lord has developed flexible rubber mountings to adequately cushion equipment against shock forces from all directions. Lord Shipping Mounts are easily installed in your own shipping cases by your packers. They are accurately designed for correct resiliency and load bearing strength to protect your product.

Users report: "No breakage on record" . . . "Haven't lost a shipment due to rough handling" . . . "Need for servicing and adjustment of machines on arrival practically eliminated."

The LORD representative in your area will recommend the type, number, and placement of Lord Shipping Mounts to safeguard your shipments. Call the nearest Lord Field Office, or write us for full information.



- Provide positive shock protection.
- Permit shipping completely assembled product.
- Reduce need for servicing and adjustment at destination.
- Eliminate packing errors . . . save time.
- Reduce fire hazard by eliminating storage of loose packing materials.

LORD MANUFACTURING COMPANY • ERIE, PA.
Canadian Representative: Railway & Power Engineering Corp. Ltd.



Vibration-Control Mountings
... **Bonded-Rubber Parts**

crystal unit for standard frequency applications incorporates two separate quartz crystals entirely independent of one another but so designed that frequency stability and zero frequency adjustment are equal on 100 and 1,000 kc. Both crystals are highly active and capable of producing high oscillator output together with instant starting when used in conventional circuits. Calibration accuracy at 28 C is plus or minus 0.005 percent. Crystals are matched so that one trimmer may be used for both crystals which can be easily adjusted to zero beat with WWV or other standard frequency.

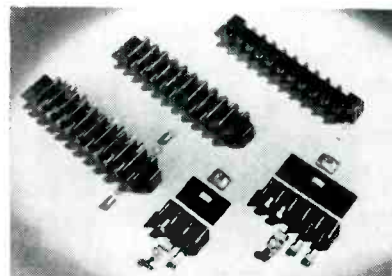

Terminal Block

SHAW INSULATOR CO., 160 Coil St., Irvington, N. J. The terminal block illustrated is made of maximum-strength molded phenolic plastic and is designed for high-voltage insulation. It completely eliminates nonfunctional materials and its compactness takes advantage of the smallest operating space. Segregated, individually accessible connections make installation and service fast and efficient. It comes with or without related hardware.

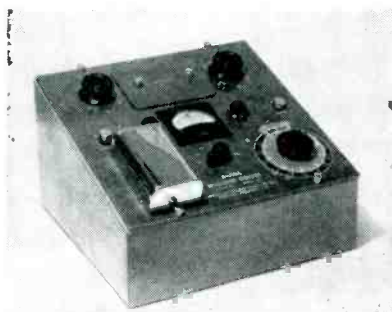

Megohm Bridge

SPECIAL INSTRUMENTS LABORATORY, INC., 1003 Highland Ave., Knox-

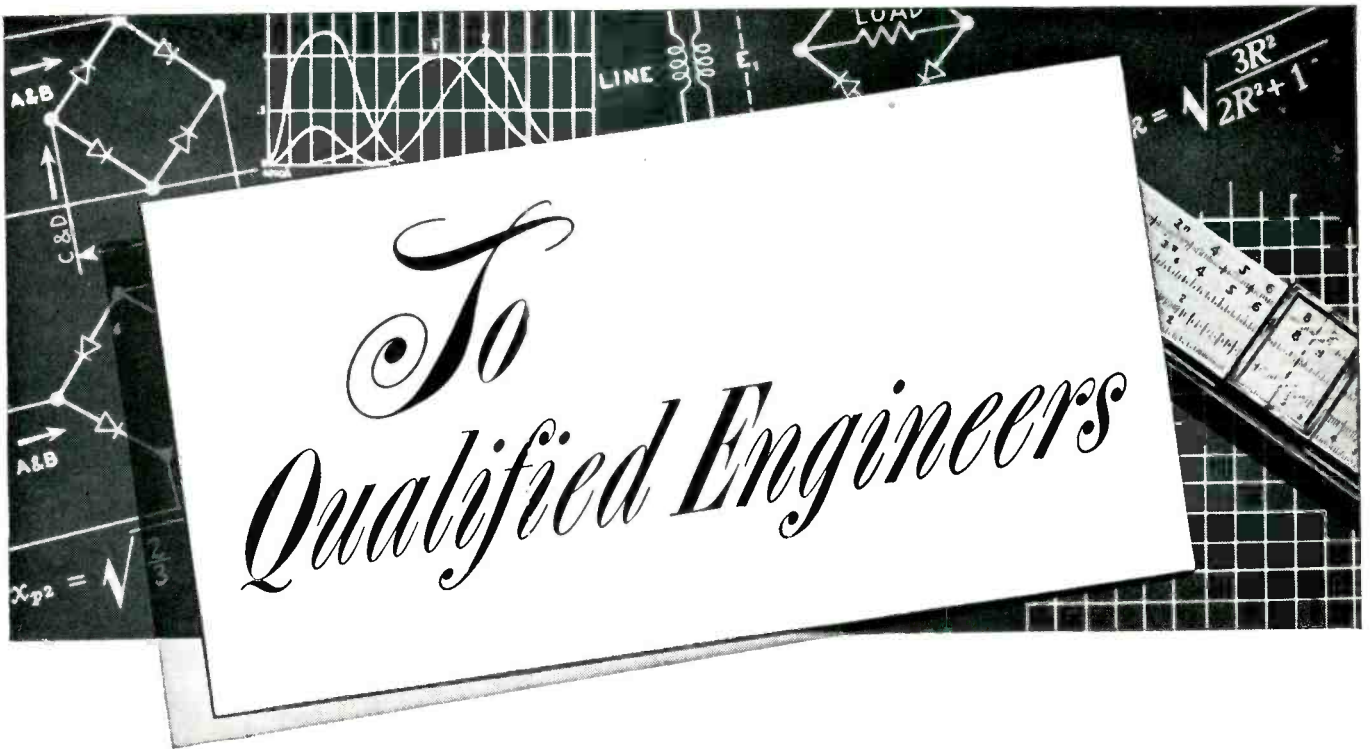

To Qualified Engineers

...extraordinary opportunity to shape your future at **RCA**

POSITIONS OPEN IN THE FOLLOWING FIELDS:

TELEVISION DEVELOPMENT—Receivers, Transmitters and Studio Equipment

ELECTRON TUBE DEVELOPMENT—Receiving, Transmitting, Cathode Ray, Phototubes and Magnetrons

TRANSFORMER and COIL DESIGN

COMMUNICATIONS—Microwave, Mobile, Aviation, Specialized Military Systems

RADAR—Circuitry, Antenna Design, Computer, Servo-Systems, Information Display Systems

NAVIGATIONAL AIDS

TECHNICAL SALES

ELECTRONIC EQUIPMENT FIELD ENGINEERS

THIS invitation is extended to ELECTRONIC, ELECTRICAL and MECHANICAL ENGINEERS . . . PHYSICISTS . . . CHEMICAL and CERAMIC ENGINEERS . . . METALLURGISTS. It enables those qualified to choose positions in the fields of electronics that are of greatest interest to them.

To experienced men with demonstrated ability, RCA offers challenging opportunities in its world-famous electron tube and equipment design laboratories. The openings provide a wide choice of interesting and basic long-term projects.

Here is a promising future for the de-

velopment and expression of your talents for personal achievement and advancement. These openings represent lifelong career opportunities independent of immediate national defense requirements.

At RCA, you enjoy professional status—pleasant surroundings in which to work—unexcelled laboratory facilities for creative work—good suburban or country residential and recreational conditions. You and your family participate in Company-paid hospitalization, accident and life insurance. Modern retirement program. Opportunities for graduate study.

Whatever your plans for the future—you will find the booklet "The Place of the Engineer in RCA" interesting reading. Mail the coupon for your free copy.



★ If you qualify for any of the positions listed here, by all means write us for a personal interview—include your résumé. Write to: *Mr. Robert McQuiston, Specialized Employment Division, Dept. S-87, Radio Corporation of America, 30 Rockefeller Plaza, New York 20, N.Y.* ★

.....

• Mr. Robert McQuiston
• Specialized Employment Division, Dept. S-36
• Radio Corporation of America
• 30 Rockefeller Plaza, New York 20, N.Y.

• Please send me copy of booklet "The Place of the Engineer in RCA."

• Name _____

• Address _____

• City _____ State _____

• List degree or degrees _____



RADIO CORPORATION of AMERICA

**A Quality Relay for
RUGGED
DUTY!**

**AMRECON
TYPE: DO
A.C. or D.C.**

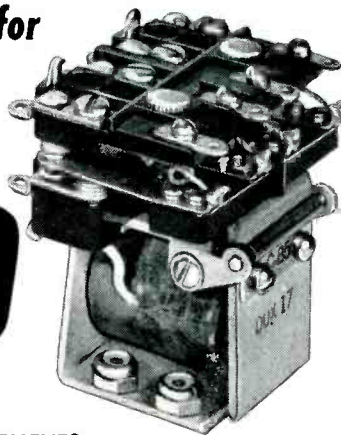

WITH CONTACT ARRANGEMENTS
UP TO 4-POLE, DOUBLE THROW

Wherever severe shock and vibration are encountered, this rugged little relay can be relied upon to give *dependable* service. Originally designed for aircraft and mobile equipment, the versatile AMRECON Type DO is adaptable to many other uses where maximum protection against mechanical injury is required. Small in size (2¼" high, 2⅞" wide, 1⅞" deep) it is available in contact arrangements up to four-pole, double throw. Coils are normally rated at 3 watts d.c., or 6 watts, 60-cycle a.c.—for voltages up to 230 volts d.c., or 440 volts a.c. Contact rating: 10 amps—at 115 volts a.c. non-inductive, or 32 volts d.c. Weight: approximately six ounces.



WRITE FOR
COMPLETE INFORMATION
American Relay & Controls, Inc.
4911 W. Flounoy St., Chicago 44, Ill.

**ANY
SIZE** *Spiral
Wound* **PAPER TUBES**

from .450" to 25" I.P.
from ½" to 30" Long

It pays to check your requirements with PARAMOUNT... because you benefit from PARAMOUNT'S coil-proved design and construction—vast range of stock arbors—wide experience in engineering special tubes! Hi-Dielectric. Hi-Strength. Kraft, Fish Paper, Red Rope, or any combination wound on automatic machines. Tolerances ± .002".

ALSO: *Shellac-Bound* Kraft paper tubing. Heated shellac forms an adhesive bond between the laminations. Absolutely moisture resistant.

**Paramount
PAPER TUBE CORP.**

616 Lafayette St., Fort Wayne, Ind.

Mfrs. of Paper Tubing for the Electrical Industry

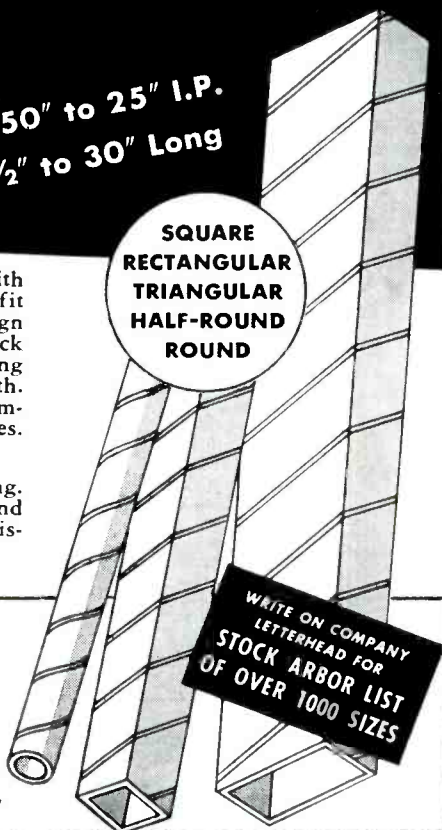

**PHYSICISTS
And
SENIOR RESEARCH
ENGINEERS**

• • •

**POSITIONS NOW
OPEN**

• • •

Senior Engineers and Physicists having outstanding academic background and experience in the fields of:

- Microwave Techniques
- Moving Target Indication
- Servomechanisms
- Applied Physics
- Gyroscopic Equipment
- Optical Equipment
- Computers
- Pulse Techniques
- Radar
- Fire Control
- Circuit Analysis
- Autopilot Design
- Applied Mathematics
- Electronic Subminiaturization
- Instrument Design
- Automatic Production Equipment
- Test Equipment
- Electronic Design
- Flight Test Instrumentation

are offered excellent working conditions and opportunities for advancement in our Aerophysics Laboratory. Salaries are commensurate with ability, experience and background. Send information as to age, education, experience and work preference to:

NORTH AMERICAN AVIATION, INC.

Aerophysics Laboratory

Box No. K-4, 12214 S. Lakewood Blvd.

DOWNEY, CALIFORNIA

ville, Tenn. Model 144 megohm bridge is a Wheatstone bridge specially designed for measurement of high resistances. Resistances of 10^7 to 10^{14} ohms can be measured. Special insulation, shielding and an electrometer type detector are incorporated to permit measurements in this range. A set of resistors calibrated by the National Bureau of Standards is supplied with each instrument. The bridge operates from self-contained batteries.

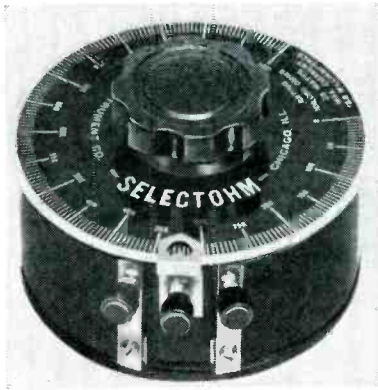

Linear Potentiometer

CHICAGO INDUSTRIAL INSTRUMENT Co., 536 W. Elm St., Chicago 10, Ill., has introduced the Selectohm, a new accurately calibrated 0 to 100,000-ohm linear potentiometer for use as a resistance substitute for service or laboratory work. It serves as a precision rheostat, shunt or multiplier, and is rated at 25 watts. Price is \$7.50.



Frequency Standard

AMERICAN TIME PRODUCTS, INC., 580 Fifth Ave., New York 19, N. Y. Type 2005 frequency standard is a

Andrew VHF and UHF "TEFLON" insulated TV TRANSMISSION LINES

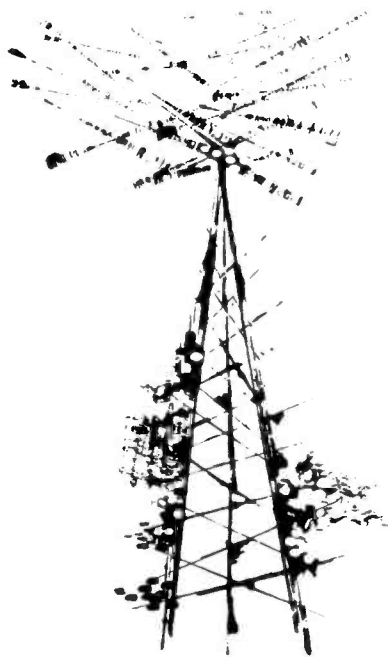
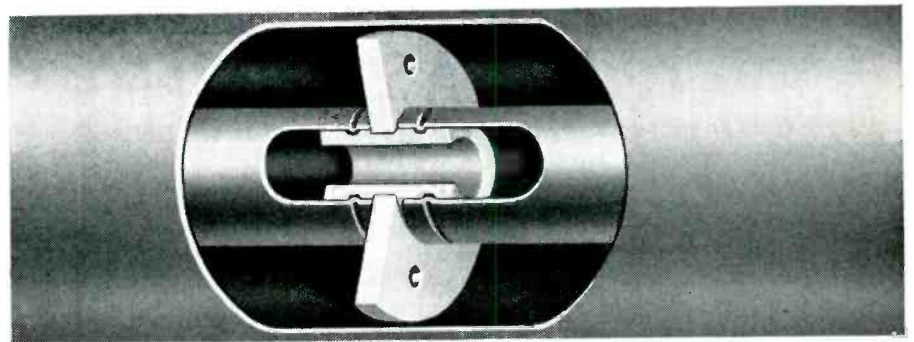

ANDREW offers a complete series of Andrew coaxial transmission lines . . . specifically designed for VHF and UHF TV frequency ranges—54-890 MCs.

Teflon insulators, with a dielectric constant of 2.0, $\frac{1}{3}$ that of steatite and a loss factor of 0.0004, $\frac{1}{10}$ that of steatite—minimize impedance discontinuity, increase efficiency . . . Andrew further compensates for insulators in $3\frac{1}{8}$ " and $6\frac{1}{8}$ " line as illustrated—on smaller diameters, insulators are secured in a rolled groove on the inner conductor. A complete line of hangers, elbows, gas barriers and other accessories are available.

FREE

Andrew Bulletin 73—to help you select correct transmission line for your TV station—a complete table of power ratings and loss data for use over entire UHF and VHF TV bands— No obligation—write for your copy today!

Andrew
CORPORATION

363 EAST 75th STREET CHICAGO 19

WORLD'S LARGEST ANTENNA EQUIPMENT SPECIALISTS
TRANSMISSION LINES FOR AM-FM-TV · ANTENNAS · DIRECTIONAL ANTENNA EQUIPMENT
ANTENNA FEEDING GRIDS · TOWER LIGHTING EQUIPMENT



ANDREW CORPORATION
363 E. 75th Street, Chicago 19

Please send me a copy of Bulletin 73 describing VHF and UHF Television Transmission lines.

Name

Title

Company

Address

City Zone State

FOR YOUR PANEL

A NOVEL and UNIQUE CIRCUIT INDICATOR

DIALCO

DESIGNED FOR NE-5T NEON LAMP

For 110 or 220 volt circuits

The required resistor is an integral part of this assembly — "built-in."

**RUGGED • DEPENDABLE
LOW IN COST**



PATENTED: No. 2,421,321
Cat. No. 521308-997



WILL YOU TRY A SAMPLE?

Write on your company letterhead. We will act at once. No charge, of course.

SEND FOR THE 192 PAGE HANDBOOK OF PILOT LIGHTS

Among our thousands of Pilot Light Assemblies there is one which will fit your special conditions. Many are especially made and approved for military use. We pride ourselves on prompt deliveries—any quantity.

ASK FOR OUR APPLICATION ENGINEERING SERVICE

Foremost Manufacturer of Pilot Lights

The DIAL LIGHT COMPANY of AMERICA

900 BROADWAY, NEW YORK 3, N. Y. SPRING 7-1300

**Watch
This
Spot!**

for
**PICTORIAL
NEWS OF
THE WORLD'S
FINEST
HERMETIC
SEALS**



• JULY, 1951 •

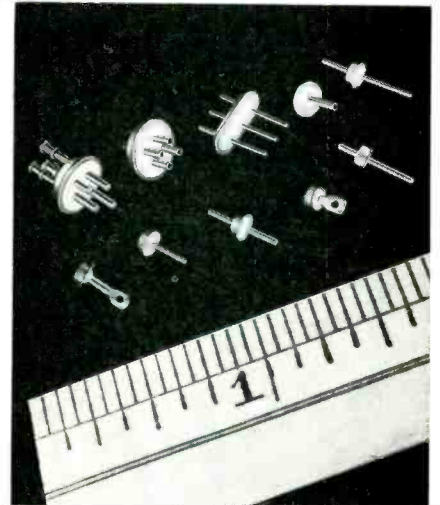

HEATHKITS OFFER UNMATCHED ADVANTAGES

 Heathkit TV ALIGNMENT GENERATOR KIT \$39.50	 Heathkit OSCILLOSCOPE KIT \$39.50	 Heathkit TUBE CHECKER KIT \$29.50	 Heathkit VACUUM TUBE VOLTMETER KIT \$23.50
 Heathkit SIGNAL TRACER KIT \$19.50	 Heathkit CONDENSER CHECKER KIT \$19.50	 Heathkit AUDIO GENERATOR KIT \$34.50	 Heathkit ELECTRONIC SWITCH KIT \$19.50
 Heathkit IMPEDANCE BRIDGE KIT \$69.50	 Heathkit RF SIGNAL GENERATOR KIT \$19.50	 Heathkit BATTERY ELIMINATOR KIT \$22.50	 Heathkit HANDTESTER KIT \$13.50

You'll find unmatched advantages in HEATHKITS—the most complete line of test equipment in kit form. Careful engineering and extensive laboratory testing in the development of each kit, coupled with the use of only highest quality components give you RUGGED, DEPENDABLE, and ACCURATE test equipment.

You SAVE MONEY when you build your own because all expensive factory wiring and construction costs are completely eliminated. . . .

All kits are COMPLETE and a real pleasure to build—Every part necessary is furnished—and the clear, detailed instruction manual makes construction easy and educational. (And, the finished kits are truly professional in appearance.)

Order your HEATHKIT today and enjoy these tremendous advantages!

HEATH COMPANY
BENTON HARBOR 14, MICHIGAN

EXPORT AGENT: ROCKE INTERNATIONAL CORP., 13 EAST 40th STREET, NEW YORK CITY 16

Quality plus unlimited shapes

The only seals you can hot tin dip at 525°F. for easy assembly soldering, for a strain and fissure-free sealed part with resistance of over 10,000 megohms!

Hermetic headers withstand high vacuum, high pressure, temperature cycling, salt water immersion and spray etc., and are used extensively by America's leading industries and government agencies.

**TERMINALS AND HEADERS ARE
AVAILABLE IN RMA COLOR CODE**



Free!

Write for your copy of the most complete catalog ever produced on hermetic seals.



**HERMETIC SEAL
PRODUCTS COMPANY**

31-33 So. Sixth St., Newark 7, N.J.

useful laboratory tool, suitable for running gyros, small motors, controlling inverters, stroboscopes and the like. Input power is 45 watts at 110 volts from 50 to 500 cycles. Output power is 10 watts at 115 volts at any specified frequency from 50 to 500 cycles. Accuracy is ± 0.001 percent in room temperature range. It measures 8 in. \times 8 in. \times 7 $\frac{1}{4}$ in. high.

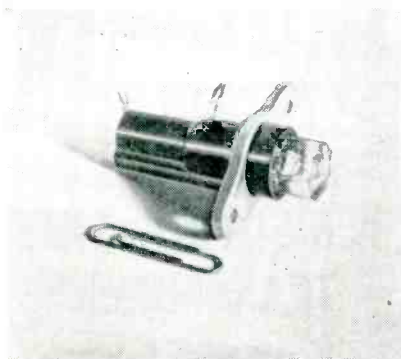

Indicating Fuseholder

ALDEN PRODUCTS Co., 117 N. Main St., Brockton 64, Mass., has developed model 440-3FH miniaturized indicating fuseholder that instantly spots a blown fuse. Its design features a neon bulb and double contacts molded as an integral part of the crystal-clear lens. The unit is ideally suited to mass production assembly techniques. It has easily accessible solder tabs that facilitate wiring and assembly to other circuit elements.

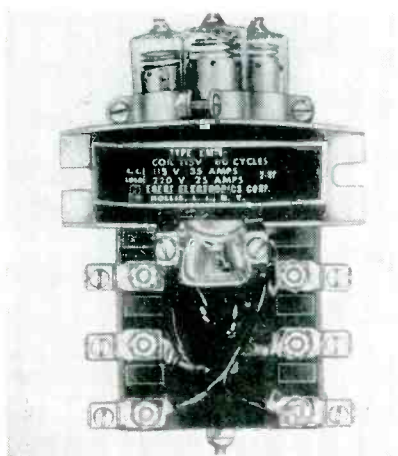

Three-Pole Relay

EBERT ELECTRONICS CORP., 185-09 Jamaica Ave., Hollis 7, N. Y. Type

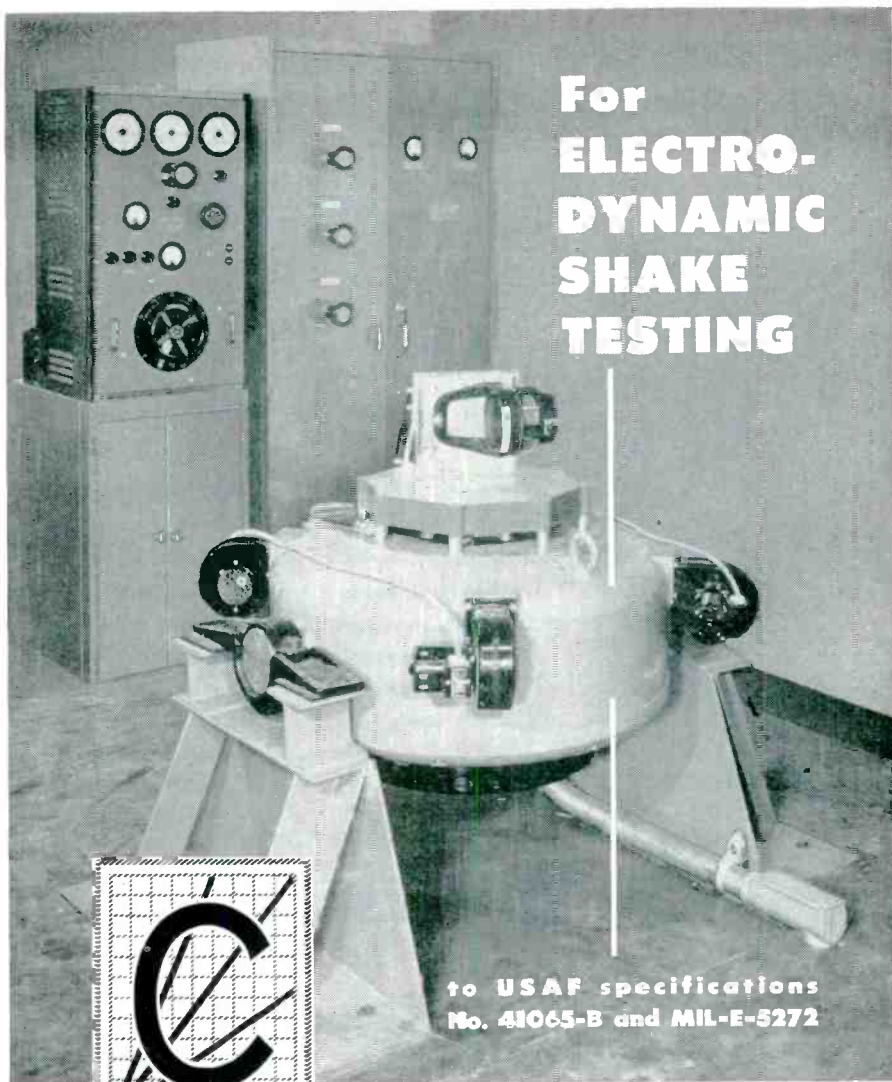

For
**ELECTRO-DYNAMIC
SHAKE
TESTING**

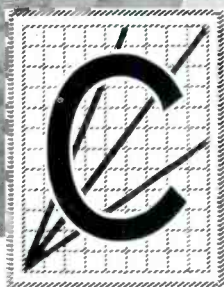

to USAF specifications
No. 41065-B and MIL-E-5272

The largest commercially available equipment for shake testing according to military specifications is now in service at Sperry Gyroscope Company. Developed by Calidyne to deliver a force output of 2500 pounds at frequencies up to 500 cycles per second, this electro-dynamic shaker, with its associated power supply and control system, is the latest addition to Calidyne's complete line of equipment for vibration studies.

Further original Calidyne developments in the field of vibration investigation include other electro-dynamic shakers, vibration pick-ups, couplers, vibration standards, vibration meters, and calibrators for accelerometers and vibration pick-ups. Each of these was produced to satisfy a recognized need in vibration research and the advanced thinking they demonstrate has earned their extensive use in diverse fields of engineering.

When you need sure knowledge of vibration and its effects, you need Calidyne apparatus. Write for your free copy of data sheet EBG-517.

SALES REPRESENTATIVES IN			
NEW YORK, N. Y.		WASHINGTON, D. C.	
G. C. Brigel • Resistor 7-0091		F. R. Jodan • Unibak 8744 Republic 1635	
CHICAGO, ILLINOIS		PHILADELPHIA, PENNA.	
H. W. Marston • Anderson 1-4954		D. J. Connor Co. • Locust 4-2870	
FLORIDA		DALLAS, TEXAS	
A. M. Lynch and Associates Park Meyers 5-6762		J. A. Green Co. • Dixie 9118	
751 MAIN STREET WINCHESTER, MASSACHUSETTS			
THE CALIDYNE COMPANY			
MINNEAPOLIS, MINN.	HOLLYWOOD, CAL.	CLEVELAND, OHIO	PORTLAND, OREGON
H. M. Richardson and Co. • Geneva 4078	B. B. Miller Co. • Hollywood 9-6305	M. P. Clidell Co. • Prospect 1-6171	J. L. Keires • East 4131

AEROCOM MEANS TROUBLE-FREE SERVICE!

From Ground To Air or Point to Point

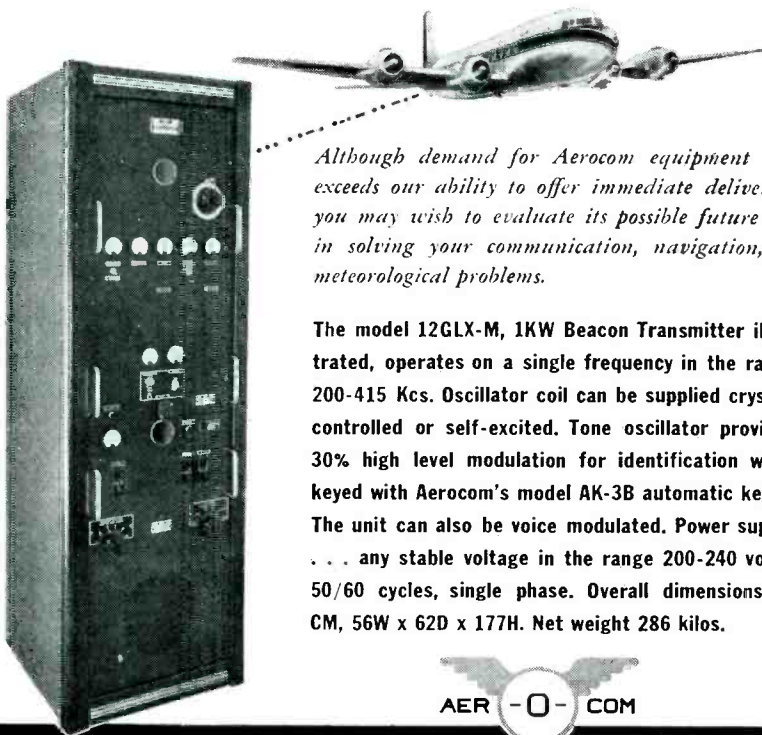

Although demand for Aeroacom equipment still exceeds our ability to offer immediate deliveries, you may wish to evaluate its possible future use in solving your communication, navigation, or meteorological problems.

The model 12GLX-M, 1KW Beacon Transmitter illustrated, operates on a single frequency in the range 200-415 Kcs. Oscillator coil can be supplied crystal-controlled or self-excited. Tone oscillator provides 30% high level modulation for identification when keyed with Aeroacom's model AK-3B automatic keyer. The unit can also be voice modulated. Power supply . . . any stable voltage in the range 200-240 volts, 50/60 cycles, single phase. Overall dimensions in CM, 56W x 62D x 177H. Net weight 286 kilos.



3090 DOUGLAS ROAD

MIAMI 33, FLA.

Reg. U. S.

Pat. Off.

A MODERN CRYSTAL

... for Modern Equipment

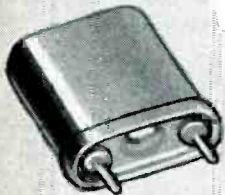

SPECIFICATIONS

Frequency range 200 kc to 100 mc. Hermetically sealed metal holders. Wire mounted, silver plated crystals. Two type H-17 holders fit octal socket. H-17 is military type HC6/U, CAATC #3R1-3.

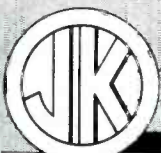

CRYSTALS

THE JAMES KNIGHTS CO.
SANDWICH, ILLINOIS

Don't limit the performance of your new electronic equipment by specifying yesterday's crystals. The crystal industry has made tremendous advances in recent years and new type JK Crystals and Crystal Holders meet the most modern requirements of precision and stability.

The JAMES KNIGHTS COMPANY invites your attention to the exceptionally fine H-17 series — a typical line of truly modern and dependable JK crystals. Compare the specifications and features of the H-17 with the "old fashioned" units of five years ago. Then you, too, will want to specify JK Stabilized Crystals!

SMALL TRANSFORMERS



Reactors or miniature transformers produced to high quality specifications in production line quantities.

Hermetically sealed type transformers to specifications.

MEDIUM SIZE TRANSFORMERS



MIL-T-27

LARGE TRANSFORMERS

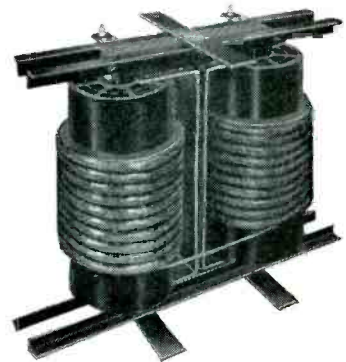

Transformers up to 225 KVA are built with attention to detail perfection to assure high performance, long-life service.

ACME ELECTRIC CORP.

317 Water St.

Cuba, N. Y., U. S. A.

Acme Electric
TRANSFORMERS

Em-7 three-pole relay employs one coil and its tungsten contacts are hermetically sealed in hydrogen-filled glass tubes. This construction provides a reliable and positive simultaneous contacting means for loads up to 35 amperes at 115 volts a-c, or 25 amperes at 220 volts a-c per contact. These relays can be supplied with all three contacts either normally open or normally closed, or with any combination of normally open and normally closed contacts. Dimensions are 4 $\frac{1}{4}$ in. wide, 5 $\frac{3}{8}$ in. tall by 3 in. deep.

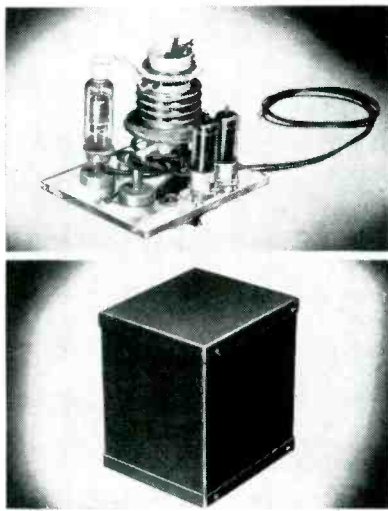

D-C Power Supply

SPELLMAN TELEVISION CORP., 3029 Webster Ave., New York 67, N. Y., has announced a new compact high-voltage unit designed for industrial or laboratory applications. It is a well-filtered 4,500 volt r-f d-c power supply, completely enclosed measuring only 5 $\frac{3}{8}$ in. \times 4 $\frac{1}{2}$ \times 5 in. Voltages up to 7,500 volts at 1 ma may be obtained. It is available with either negative or positive polarity outputs.

ULF Oscillator

KROHN-HITE INSTRUMENT Co., 580 Massachusetts Ave., Cambridge 39, Mass. Model 410-A ultralow frequency oscillator covers the sub-audio and the entire audio range. It provides both sine wave and square wave at any frequency range between 0.02 and 20,000 cps. The unit is ideal for medical research,

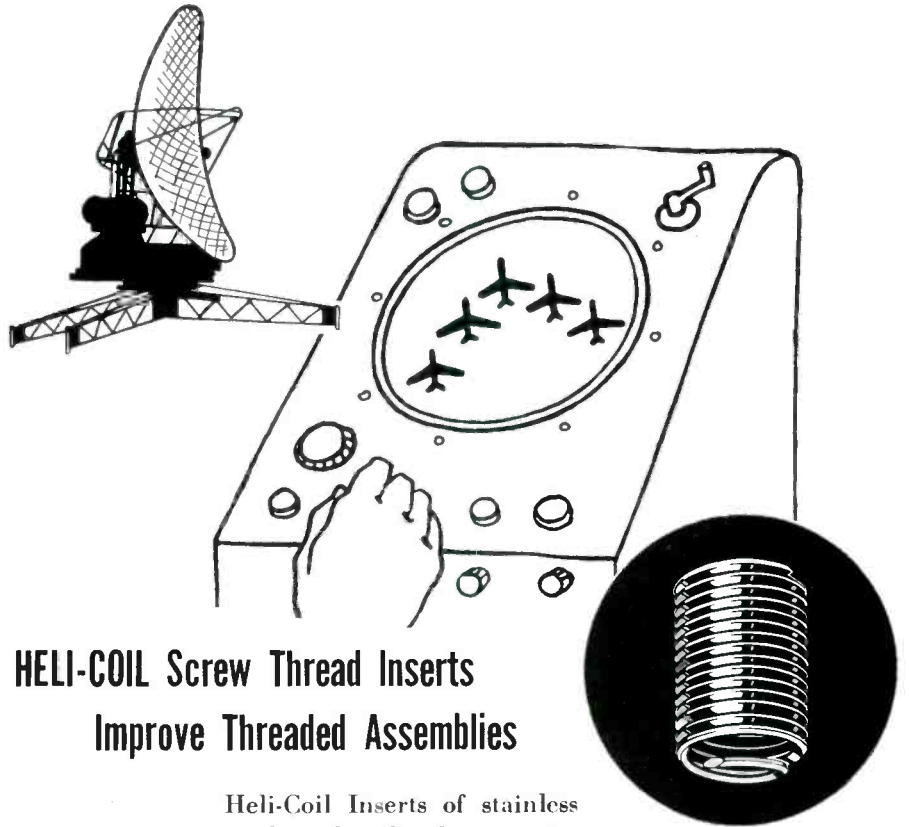

**HELI-COIL Screw Thread Inserts
Improve Threaded Assemblies**

Heli-Coil Inserts of stainless steel or phosphor bronze wire can provide an armored thread in every tapped hole, in any material . . . eliminate wear, add strength, prevent stripping and seizing, resist corrosion and galling. Valuable savings in weight and space are possible where these precision-formed wire inserts are used.

Heli-Coil Inserts meet all industrial and military requirements for fatigue, vibration, corrosion, tension and torsion loads. Design is improved, production accelerated, assembly and disassembly greatly simplified with Heli-Coil Inserts.

Heli-Coil Screw Thread Inserts outlast the protected product and guarantee permanent freedom from screw thread troubles. Made in National Coarse and Fine Threads, Unified Thread Series, pipe thread sizes and in aircraft and automotive spark plug sizes. Meet all industrial, military, and aircraft specifications. Class 3 fits are standard; tools and inserts available to suit pitch and major diameter for Class 2 and 2B fits.

HELI-COIL



Protecting Screw Threads for Industry

CORPORATION

Heli-Coil
is a Registered
U. S. Tradename

HELI-COIL CORPORATION
DANBURY, CONNECTICUT

Please send me
 Bulletin 650-R on Design Data
 Bulletin 349 on Salvage and Service

NAME _____
FIRM _____
STREET _____
CITY _____ ZONE _____ STATE _____

LET **NEY** EXPERIENCE AND
EXPANDED PRODUCTION FACILITIES
SOLVE YOUR
CONTACT PROBLEMS

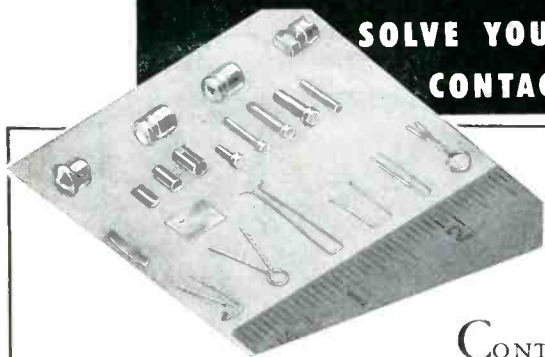

CONTACTS, brushes, wipers, slip rings, commutator segments and similar components for electrical instruments and apparatus represent a field in which Ney Research has a long list of important accomplishments. Ney precious metal alloys specially developed for these applications are widely and very successfully used. And now enlarged manufacturing facilities have been added to meet the steadily increasing demand. If you have applications in any of these categories, write at once for the Ney Technical Data Book No. R-12. Or call our Engineering Department outlining your needs.

THE J. M. NEY COMPANY • 179 Elm Street
HARTFORD 1, CONNECTICUT

Independent
Research Proves:

2 out of 3 Engineers Prefer BURGESS BATTERIES!

NO WONDER Burgess is the first source for industrial dry batteries. Burgess long-life dependability and uniform, high-level performance are backed by more years of engineering "know-how" than any other batteries. The maintenance of highest quality always is the reason why 2 out of 3 engineers prefer Burgess... by independent survey. Check for your local source of supply or write now!

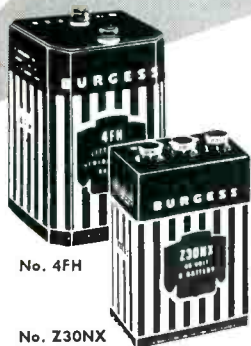

WRITE FOR ENGINEERING MANUAL AND CHECK SHEET—No obligation. By return mail you will receive the FREE Engineering Manual listing the complete line of Burgess Batteries together with detailed specifications; also the Burgess "Check Sheet" on which you may outline your battery requirements in the event that the battery you need has not already been developed. Address:

BURGESS BATTERY COMPANY
(DEPT. E-7) FREEPORT, ILLINOIS

DC - AC CHOPPER

A model for every use
10 — 500 cycles AC
Meets AN Specifications
also 60 cycles
Single pole and double pole
Make-before-break contacts
Contacts in air or in liquid

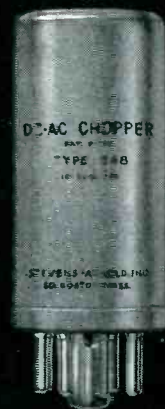

These Choppers convert low level DC into pulsating DC or AC so that servo-mechanism error voltages and the output of thermocouples and strain gauges, may be amplified by means of an AC rather than a DC amplifier. They are hermetically sealed, precision vibrators having special features which contribute to long life and low noise level.



WRITE FOR THESE
CATALOGS...

#280
10-500 cycles
#246A
60 cycles

**STEVENS
ARNOLD
INCORPORATED**

22 ELKINS STREET
SOUTH BOSTON 27, MASS.

SA-4

for geophysical and seismological instruments, for design and development of servomechanisms and for vibration controls. Sine-wave amplitude varies less than 0.25 db (3 percent) over the entire frequency range. Distortion and hum are less than 0.25 percent over the entire range.

Literature

Data Bulletins. International Resistance Co., 401 N. Broad St., Philadelphia 8, Pa., has available 7 catalog data bulletins dealing with the following: type MP high-frequency resistors; type MV high-voltage resistors; type BW insulated wire-wound resistors; type UHR ultrahigh wire-wound resistors; a line of precision wire-wound resistors; the 1101 general-purpose digital computer; and the type W 2-watt rheostat potentiometer. Complete technical information and illustrations are included.

Autographic Recorder. Baldwin-Lima-Hamilton Corp., Philadelphia 42, Pa., announces the 4-page bulletin 330 describing and illustrating the model MD-2 autograph recorder. The instrument described is a portable, self-contained Microformer type that will plot automatically on rectangular coordinates any two variables that can actuate the movable cores of miniature variable transformers, either directly or through accessory Bourdon tube units.

Cellular Rubber. The Sponge Rubber Products Co., Derby Place, Shelton, Conn. A 20-page booklet deals with the properties of test data on and specifications for cellular rubber. The product is useful as a turntable cushion to prevent transmission of motor vibrations to recording discs; as an amplifier insulator to provide a wall of insulation between plug-in amplifier and main electrical chassis; and as hand microphone spacers to protect the element from damage and insulate it against transmitting the sound that would oth-

There's a TIC[®] Potentiometer for every application

Miniaturization of precision potentiometers is keeping pace with the increased demand for smaller assemblies and compact design. Now you can minimize wasted space with TIC's outstanding, new RV 7/8" and RV 1-1/6" Miniature Potentiometers.

In spite of their thumbnail size the RV 7/8" and the RV 1-1/6" are precision, high linearity variable resistors, (or adjustable trimmers) of high stability — achieving a standard of performance hitherto unavailable in such miniature potentiometers.

Construction features include: precision machined aluminum base . . . low torque . . . all soldered connections except sliding contacts . . . paliney contacts can be sealed to withstand all humidity, salt spray and altitude specifications. Ganging if desired with TIC adjustable clamp ring.

RV 7/8" available with linear resistance elements only — nine standard resistance values from 100 to 25,000 ohms. Power rating 6 watts at 25°C. Illustration shows RV 7/8" with threaded bushing . . . servo mounting available if desired.

RV 1-1/6" available with linear or non-linear resistance elements — nine standard resistance values from 100 to 50,000 ohms. Illustration shows RV 1-1/6" with 3 tapped hole mounting . . . servo mounting or threaded bushing if desired.



Type RV1 7/8" and RV2" High Precision Potentiometers . . . semi-standardized types of precision machined aluminum base potentiometers with exceptionally high electrical accuracy and mechanical precision. For both linear and non-linear functions. Designed for precision instrument, computer and military applications. Accurate phasing of individual units possible with clamp-ring method of ganging. Ball bearing models available.

*Numbers refer to diameter of buses.

Tapped mounting inserts
Bronze bushing
Totally enclosed with cover
"Constrict-O-Grip" clamping to shaft
(no set screws)
Precious metal contacts
Silver overlay on rotor take-off slip ring

Sine and cosine potentiometers available in RVP3* and RV2* bases.

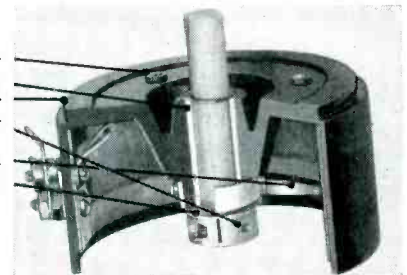

Type RV3* Bakelite Base Precision Potentiometers . . . available in models for either linear or non-linear functions. Stock resistance values ranging from 100 Ω to 200,000 Ω and power ratings of 8 and 12 watts. 360° mechanical rotation or limited by stops as desired. Potentiometers of this type available to widely varying accuracy requirements (linearity to ±0.25%) — see TIC Bulletin RV3-250. Special models available for high humidity applications.

Type RVP3* High Precision machined aluminum base Potentiometers . . . available in models for either linear or non-linear functions with standard resistance values up to 200,000 Ω. Linearity to ±0.1%. Eleven gang assembly available, example of TIC's potentiometers multi-ganged with TIC's adjustable clamp ring. Can be supplied to meet various mounting requirements — single hole, 3 tapped hole mounting or servo mounting as desired.

Type RVT Translatory Potentiometers . . . actuated by longitudinal instead of rotary motion providing linear electrical output proportional to shaft displacement. Used as a position indicator, high amplitude displacement type pickup and for studying low frequency motion or vibration. Features exceptionally high linearity and resolution. Available in various lengths and resistance values.

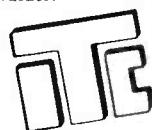
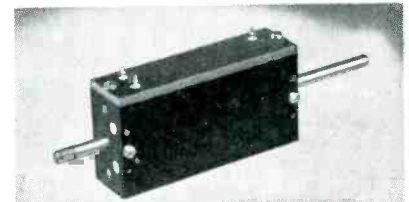

TECHNOLOGY INSTRUMENT CORP.

531 Main Street, Acton, Mass.

Telephone: Acton 600

Engineering Representatives

Cleveland, Ohio — PProspect 1-6171
Chicago, Ill. — UPrown 8-1141
Rochester, N. Y. — Monroe 3143
Canaan, Conn. — Canaan 649
Dayton, Ohio — Michigan 8721

Manhasset, N. Y. — Manhasset 7-3424
Boonton, N. J. — Boonton 8-3097
Cambridge, Mass. — ELiot 4-1751
Hollywood, Cal. — HOLlywood 9-6305
Dallas, Texas — DLxon 9918

SERVOSCOPE®



Test analyzer for use in development and PRODUCTION of SERVOMECHANISMS and PROCESS CONTROLS. Measures FREQUENCY RESPONSE, PHASE SHIFT 0.1 to 20 CYCLES SINE WAVE, SQUARE WAVE, MODULATED CARRIER, 50 to 800 CYCLES.

SERVOBOARD

A FLEXIBLE SET of PRECISION mechanical parts for quickly coupling motors, synchros, potentiometers to form assemblies of Servo systems, regulators, computers.

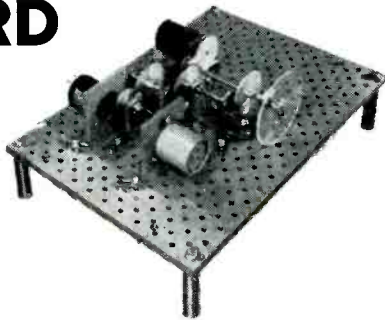

SERVO CORPORATION
OF AMERICA

DEPT. E-7

NEW HYDE PARK, N.Y.



Development Engineers...
Research Engineers... Designers...
This could be your

Opportunity of a Lifetime!

Continued expansion in many of the divisions of Minneapolis-Honeywell—America's leading manufacturer of automatic controls—has created some wonderful new opportunities for graduate electrical and mechanical engineers with research, design or development experience.

Jobs are now available in the all-important heating, ventilating, air-conditioning, industrial processing, and a myriad of other fields—wherever there is a need for automatic controls. And this includes the fascinating new fields of atomic energy, guided missiles and aviation!

These permanent engineering jobs offer you advantages most men spend a lifetime looking for: an opportunity to use the latest electronic techniques and equipment; a chance to do work bordering on basic research; diversification that affords security, and at the same time allows you to choose the kind of work you like most.

If this sounds like your kind of opportunity, we'd be glad to tell you more about it—and about the fine living conditions and salaries in Minneapolis and Philadelphia. Depending on the location you prefer, write to H. D. Elverum, Personnel Department EL-1, Minneapolis 8, Minn., or W. Reiterman, Personnel Department EL-1, Philadelphia 44, Pa., giving your qualifications and experience. Your correspondence will be held in the strictest confidence, of course.

MINNEAPOLIS
Honeywell

First in Controls



IT'S ALLIED FOR RCA



Electron Tubes for Industry

Quick, Expert Service on RCA Tubes

ALLIED maintains in stock for quick shipment, the world's largest distributor inventory of RCA special-purpose tubes—of all types. We specialize in supplying the needs of industrial, broadcast, governmental and other users. To save time, effort and money—phone, wire or write to ALLIED. Fill all your needs quickly from the complete, dependable electronic supply source.

See Your ALLIED Catalog

Refer to your ALLIED Catalog for all electronic supplies—parts, tubes, test instruments, tools, audio amplifiers, accessories—available from the world's largest stocks. Write today for your FREE copy of the complete 212-page ALLIED Catalog.



ALLIED RADIO

833 W. Jackson Blvd., Dept. 11-G-1, Chicago 7, Ill.

ALL TYPES IN STOCK

- Vacuum Power
- Thyratrons
- Vacuum & Gas. Rect.
- Ignitrons
- Cold-Cathode
- Phototubes
- Oscillograph Tubes
- Camera Tubes
- Monoscopes
- Special Types

FREE Interchangeability Directory

Valuable guide to selection of proper RCA tube type replacements. Lists 1600 tube types. Write for FREE RCA Guide No. 37-046.

Everything in Electronics from ONE Source

erwise result from dropping or banging the microphone.

Connectors. American Phenolic Corp., 1830 South 54th Ave., Chicago, Ill. Catalog A2 contains information for selecting and ordering AN connectors for power, signal and control circuits in aircraft and electronic equipment. The different types of connector shells, insert arrangements and fittings are illustrated. Complete listings of the thousands of arrangements are given. Dimensions, weights and electrical data are shown in detail.

Vibration Isolators. The Barry Corp., 700 Pleasant St., Watertown, Mass. Catalog 509 discusses the structural features of all-metal vibration isolators that employ no organic material and are unaffected by extreme temperatures. Unit mountings, for direct attachment to equipment, and standard size mounting bases are described. The mountings covered meet the requirements of JAN-C-172A, MIL-E 5272 and MIL-T-5422. The publication lists load ranges and dimensions of both unit and mounting base types.

Direct-Writing Recorder Amplifier. Baldwin-Lima-Hamilton Corp., Philadelphia 42, Pa., has published bulletin 332 covering the model 141 direct-writing recorder-amplifier assembly. The instrument described is designed for inkless recording of electrical unbalance of a resistance bridge when using strain sensitive elements such as SR-4 strain gages or temperature-sensitive elements. The bulletin deals with performance and operation of amplifier and recorder assemblies, and lists available accessories.

Miniature Standard Cell. Muirhead & Co., Ltd., Beckenham, Kent, England, has issued a 2-page bulletin dealing with the type D-550-B miniature standard cell that has been produced especially for use in educational establishments where it is desirable that its internal construction should be visible so that its working may be more easily understood. Specifici-



THEY CHOSE

Magne recorder

THE FIRST CHOICE OF RADIO ENGINEERS

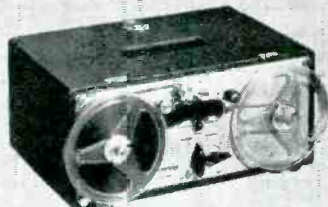

FLEXIBILITY

In rack or console, or in its really portable cases, the Magne recorder will suit every purpose. PT6 Series shown is the most widely used professional tape recorder in the world, and is available with 3 speeds (3 3/4, 7 1/2, 15") if preferred.

FIDELITY

Lifelike tone quality, low distortion meet N.A.S. standards — and at a moderate price! PT63 Series shown in rack mount also offers three heads to erase, record, and play back to monitor from the tape while recording.

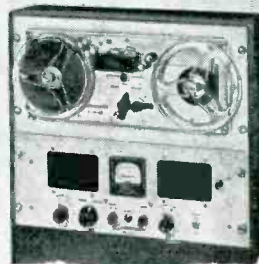

FEATURES

PT7 accommodates 10 1/2" reels and offers 3 heads, positive timing and pushbutton control. PT7 Series shown in complete console model is also available for portable or rack mount. For outstanding recording equipment, see the complete Magne cord line — PT6, PT63 and PT7.

WRITE FOR NEW CATALOG



360 NORTH MICHIGAN AVENUE
CHICAGO 1, ILLINOIS

Magne cord, Inc., Dept. EB-7
360 N. Michigan Ave., Chicago 1, Ill.
Send me latest catalog of Magne cord Equipment.

Name.....
Address.....
City..... Zone..... State.....

5 Big Reasons WHY AIRPAX CHOPPERS ARE AN ESTABLISHED STANDARD FOR THE INDUSTRY!

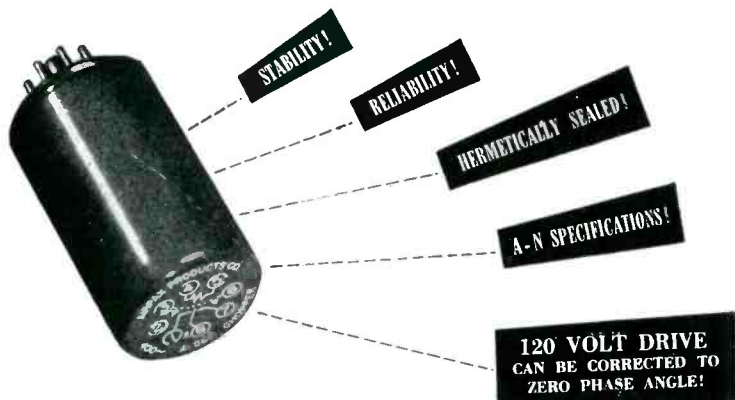

AIRPAX A580 400 CYCLE CHOPPERS

Modulating minute DC potentials, this chopper combines rugged action with sensitivity and precision for delicate servo applications.



WITH SIGNAL GENERATORS

by
AIRCRAFT RADIO Corporation

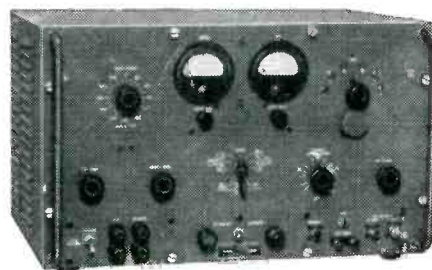

TYPE H-14 108-132 MEGACYCLES

Standard signal source for complete testing of VHF airborne omnirange and localizer receivers in aircraft or on the bench is ARC's Type H-14 Signal Generator. It checks up to 24 omni courses, omni course sensitivity, to-from and flag-alarm operation, left-center-right on 90/150 cycle and phase-localizers, and all necessary quantitative bench tests. Permits quick, accurate, check-out of aircraft just before take-off. For ramp checks RF output 1 volt into 52 ohm line; for bench checks, 0-10,000 microvolts. AF output available for bench maintenance and trouble shooting.

Price \$885.00 net, f.o.b. Boonton, N. J.

Type H-12 VHF Signal Generator
900 - 2100 mc - source of cw or pulse amplitude-modulated RF. Power level 0 to -120 dbm. Internal pulse circuits with controls for width, delay, and rate, and provision for external pulsing. Frequency calibration better than 1%. Built to Navy specs for research, production testing. Equal to Military TS-419/U.



Price: \$1,950.00 net
f.o.b. Boonton, N. J.

AIRCRAFT RADIO CORPORATION
Boonton New Jersey
Dependable Electronic Equipment Since 1928

ZOPHAR

WAXES COMPOUNDS

Anti-Corona high heat-resistant compounds for Fly Back Transformers.

Waxes and compounds from 100° F to 285° F Melting Points for electrical, radio, television, and electronic components of all types.

Pioneers in fungus-resistant waxes.

Our efficient and experienced laboratory staff is at your service.



ZOPHAR MILLS, INC.
112-130 26th Street,
Brooklyn 32, N. Y.

cations given include general description, electrical characteristics, current discharge rate and dimensions.

Pneumatic Tools. Newage International, Inc., 235 E. 42nd St., New York, N. Y. Catalog PT deals with a complete line of pneumatic tools including drills, screwdrivers and nut runners, countersinking tools, shears, nibblers, grinders and accessories. An illustrated description of each tool is given.

Tube Catalog. General Electric Co., Syracuse, N. Y. A new 107-page pocket-size handbook lists the essential characteristics of every tube likely to be found in any a-m, f-m or tv home receiver. The reference contains ratings and other data essential to fast, efficient trouble shooting. Basing diagrams for each of the 856 different tube types listed are shown on the page with the data. Price is 35 cents.

Electrical Insulation. The INSL-X Co., Inc., Water St., Ossining, N. Y., has issued a booklet on its electrical insulating and specialty compounds. Among the many uses of the basic raw material covered are fungicidal coatings, arc-resisting coatings, coil coatings, tool insulation and insulating varnishes. Complete technical description, curing-time-hours chart and price list are included.

Microwave Test Equipment. Kings Microwave Co., Inc., 50 Marbledale Rd., Tuckahoe 7, N. Y. A recent 24-page booklet deals with a line of microwave test equipment and components. Included are illustrated descriptions of high-power terminations, tees, water loads, low-power waveguide terminations, glide screw tuners, flap attenuators, bidirectional couplers, micrometer wavemeters, waveguide chokes and flanges and similar equipment.

Silvered Mica Capacitor. Cornell-Dubilier Electric Corp., South Plainfield, N. J. Bulletin NB 141 announces the type 22R high-stability silvered mica capacitor in

High Temperatures? Small Space? Severe Conditions?



Today's trend towards miniaturization makes severe demands on electronic wiring. That is why so many leading electronic equipment manufacturers specify Rome Synthinol 901. A resin plasticized polyvinyl chloride thermoplastic compound, it is Underwriters' approved for temperatures up to 105° C., as a special small-diameter type with no assigned voltage, as well as for regular 300 and 600 volt ratings.

Where space is a problem, Rome Cable engineers have developed a small-size hook-up with with an 8 mil wall of Rome Synthinol 901 insulation and an exceptionally small over-all diameter. With nylon sheath maximum diameters run from as small as .051" for 24 AWG to .100" for 16 AWG.

What's more Rome Synthinol 901 has greater resistance to heat deformation, baking embrittlement, shrinkage, cracking, solvents, moisture and flame, plus improved solderability. It is available in distinct, permanent colors, either plain or with outer coverings.

MILITARY TYPE HOOK-UP WIRE

Rome Cable is an approved manufacturer of military types SRIR, SRHV and WL, complying with Army-Navy Joint Specification JAN-C-76, as well as shipboard types SRI and SRIB conforming to Specification MIL-C-915. Insulated with Rome Synthinol thermoplastic compound, these wires are manufactured in the complete range of specification sizes.

Whatever your requirements, you can depend on Rome for electronic wires of the highest quality. The coupon will bring you descriptive literature.

MAIL IT TODAY.

ROME CABLE CORPORATION
DEPT. E-7, ROME, N. Y.

Please send me information on Electronic Wiring.

Name

Company

Address

City State

IT COSTS LESS TO BUY THE BEST

ROME CABLE CORPORATION
ROME, NEW YORK



(continued from page 148)

ton cargo vessel is at least \$2,000 a day.

Equipment to be used until the close of the experiment in December, 1951, has been furnished without cost by Sperry and Raytheon. Certain government and private craft have volunteered as target vessels and the local pilots' associations are also cooperating in the experiment.

Among the problems to be worked out are reliable radiotelephone communications between ships and the information center at Fort Wadsworth and a sure means of identifying craft from the radar scope.

MIT Promotions

FACULTY promotions at Massachusetts Institute of Technology which will become effective July 1 were recently announced. Those taking place in the department of electrical engineering are as follows:

William H. Radford of Watertown is raised to the rank of full professor; Donald P. Campbell and Robert M. Fano of Brookline are promoted from assistant to associate professors; F. Ralph Kotter, Jordan J. Baruch, Elery F. Buckley and James M. Ham of Cambridge, Ronald E. Scott of West Newton and Albert B. Van Rennes of Weston become assistant professors. Maurice Boisvert of Winthrop, Edward J. Craig of West Newton, and Cedric F. O'Donnell, Arthur L. Pike, William M. Siebert, Kenneth N. Stevens and Robert E. Turkington of Cambridge are advanced to the rank of instructor.

International Standardization Makes Progress

CONTINUING progress is being made in the direction of international standardization of electric and magnetic magnitudes and units under the auspices of Technical Committee No. 24 of the International Electro-technical Commission. Existing differences of definitions in different countries are being gradually eliminated. This, it is anticipated, will be of substan-

Check, Grade,
or Sort up to
17 capacitors
per minute

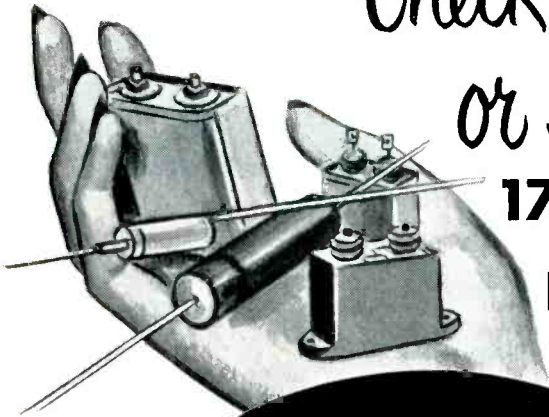

PRICE
\$690⁰⁰
F.O.B. CINCINNATI

with the New *Clippard* PC-4 CAPACITANCE COMPARATOR

Any type of condenser . . . paper, mica, oil filled, ceramic or electrolytic . . . can be graded on the PC-4 at rates up to 8000 per day by an unskilled operator. Working to an accuracy of 0.2%, the PC-4 is a companion production instrument to the famous PR-5 Automatic Resistance Comparator. Leading manufacturers have found it an indispensable tool in the fight for higher quality and lower production costs. Easy operation reduces inspection time to an absolute minimum.

Completely self-contained, the PC-4 requires no outside attach-

ments other than the Standard Capacitor against which the unknowns are to be checked. Operates on 110 Volt—60 cycle AC. Range: 10 mmfd to 1000 mfd. Size: 18" x 12" x 12". Weight: approximately 35 lbs. For complete details, write for Catalog Sheet 7-E.

Clippard

INSTRUMENT LABORATORY INC.

1125 Bank Street • Cincinnati 14, Ohio

MANUFACTURERS OF R. F. COILS AND ELECTRONIC EQUIPMENT

ELECTRONIC MOTOR and WELDER CONTROLS

Just Out

1. Here is practical help for those who must select, install, or service electronic controls for motors and resistance welders. The book explains circuit operation of tube-operated equipment found in the two major groups of motor and resistance-welding control. Each chapter starts with an introduction to a complete electronic equipment and then splits it into its component circuits, pinpointing each operation with simple descriptions and diagrams. By George M. Chute, 348 pp., 187 illus., \$6.50

ANTENNAS

2. A new book that thoroughly covers basic antenna theory, methods of antenna measurements, and their engineering applications to antennas for all frequency ranges. Treats the significant topics of point sources—power, field, and phase patterns—mutual impedances of antennas—end fire and broad-side arrays—linear, loop, slot, helical and other types of antennas . . . stressing the practical aspects of antenna problems throughout. Includes recent advances in the field, and scores of diagrams, equations, tables, and formulas supplement subjects discussed. By John D. Kraus, 533 pages, 368 illustrations, \$8.00

TRANSMISSION LINES AND NETWORKS

3. An up-to-the-minute guide book of information on the theory and applications of transmission lines and four-terminal networks. Discusses transmission lines from an analysis of a-c steady-state lines with no reflection, to special considerations for radio-frequency lines, telephone, and telegraph lines, and power transmission lines. Points up useful material on four-terminal networks, and the application of theory to attenuators, impedance-matching networks, and filters. Provides present-day transmission line charts and their use. By Walter C. Johnson, 367 pages, illustrations, \$5.00

HIGH SPEED COMPUTING DEVICES

4. Here is a practical manual that gives the various mathematical methods and physical mechanisms which have been developed for use in automatic computation. Familiarizes you with the general character of computing machines . . . outlines the arithmetic techniques employed in their operation . . . and describes basic circuits used to perform various computing machine functions. Describes computers to provide examples of the integration of techniques and components into complete systems, and discusses switches and gates, arithmetic systems, data conversion equipment, etc. Edited by W. W. Stifter, Jr., E.R.A., Inc. 440 pages, 90 illus., \$6.50

SEE THEM 10 DAYS FREE

McGraw-Hill Book Co.
330 W. 42nd St., NYC 18

Send me book(s) checked below for 10 days' examination on approval. In 10 days I will remit for book(s) I keep, plus few cents for delivery and return unwanted book(s) postpaid. (We pay for delivery if you remit with this coupon; same return privilege.)

- 1. CHUTE—Electronic Motor and Welder Control, \$6.50
- 2. KRAUS—Antennas, \$8.00
- 3. JOHNSON—Transmission Lines and Networks, \$5.00
- 4. E.R.A.—High Speed Computing Devices, \$6.50

(Print)
Name
Address
City Zone State
Company
Position L. 7-51
This offer applies to U. S. only.

NEW *precision* DIFFERENTIAL in the FORD tradition

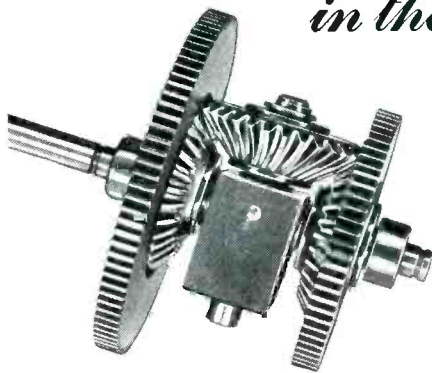

Only 1 Spider Gear

available in:

- 3/16-inch
- 1/4-inch
- 5/16-inch

shaft diameters

This new development, Ford's latest in precision computing mechanisms, incorporating Zerol gears, makes for higher accuracy, far less friction, with a resultant greater life expectancy—a differential of fine Ford precision.

- **LOW FRICTION:** This smooth-running differential is unique—its exceptionally low friction is the same in either direction.
- **HIGH ACCURACY:** Lost motion does not exceed 5 minutes of arc on the 1/4-inch and 5/16-inch differentials and 7 minutes on the 3/16-inch differential.

FORD INSTRUMENT CO.

Division of The Sperry Corporation
31-10 Thomson Avenue, Long Island City 1, N.Y.

The leaders specify
Tensolite

TYPICAL
MINIATURE WIRES and CABLES

Plastic Insulated HOOK-UP

SIZE 32 AWG (7/40)
O.D.—.030"
CODE 1507 A-1

Cotton Covered SHIELDED LEAD

SIZE 30 AWG (6/38)
O.D.—.075"
CODE 1919 D-1

SHIELDED 4-Cond. TWISTED CABLE

SIZE 27 AWG (7/35)
O.D.—.120"
CODE 2059 F-4

OTHER CONSTRUCTIONS IN STRANDED
SIZES FROM #40 TO #20 AWG

MINIATURE FLEXIBLE INSULATED WIRE & CABLE

CABLES { TWISTED
PARALLEL
BRAIDED

BARE COPPER }
TINNED COPPER } SHIELDS
SILVER PLATED }

BRAIDS { COTTON
NYLON
PLASTIC*

*TENSOLITE'S exclusive plastic film-covered Fiberglas

Leading engineers specify TENSOLITE
Miniature Wire and Cable

because- miniaturization programs demand less weight, less space and greater flexibility. Only TENSOLITE is devoted exclusively to this field — assuring you of faster service, lower cost, supreme quality, advanced design and know-how, and specialized facilities.

TENSOLITE
INSULATED WIRE CO., INC.
196 MAIN STREET, TARRYTOWN, N. Y.
Tarrytown 4-2616

• Free wire samples and information on request. Special constructions made to your specifications.

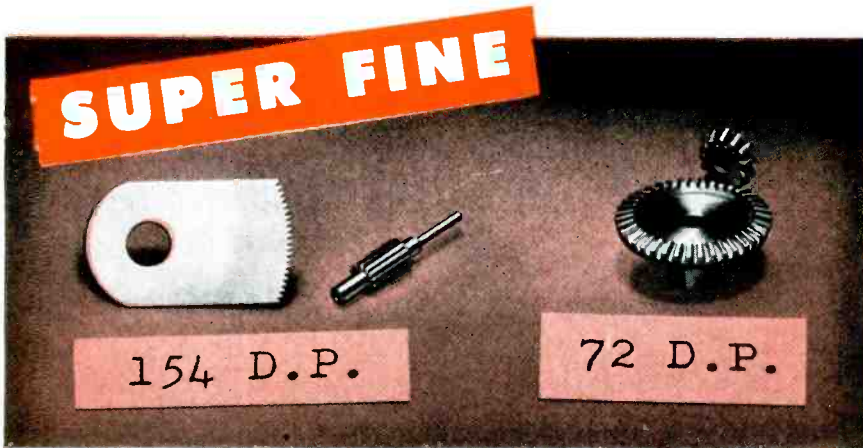

● If your requirements are for extra fine-pitch gears and pinions with precision tolerances, send us your prints for quotation. Beaver Gear engineers are trained to assist you in the design and application of this type gear. Our workmen are specialists in manufacturing small and medium size, fine and extra fine-pitch gears to your most exacting specifications.

MEMBER OF



SEND FOR BULLETIN

Beaver Gear Works Inc.

1021 PARMELE STREET, ROCKFORD, ILLINOIS

tial benefit to electrical engineering throughout the world.

One of the overall objectives of Technical Committee No. 24 is to formulate for general acceptance the MKS (meter-kilogram-second) system, sometimes called the Giorgi System. The MKS system has the advantage that its use results in units of current, voltage, and resistance which are respectively the ampere, the volt, and the ohm. This makes it more suitable for engineering work than the CGS (centimeter-gram-second) system, which is in widespread use. It is recognized, however, that the CGS System has certain advantages for physicists. There is no thought of replacing one by the other, but simply of providing a second system that will be particularly helpful to engineers.

Prior to World War II, meetings of Technical Committee No. 24 were held on an average of about once every two years. Due to the war and later the death of the committee's chairman, Professor Kennedy of MIT, no meetings were held from 1938 until last summer when the Committee met in Paris on July 17 and 18.

Questions raised by delegates at the Paris meeting were also proposed for consideration at the Committee's next meeting. These included (1) the most satisfactory name to be assigned to the MKS System; (2) the name to be assigned to the unit of induction; and (3) possible merger of Technical Committees No. 24 and 25. Opinions are being sought from all of the National Committees concerning these matters. This work in the United States is being done through the Sectional Committee on Electric and Magnetic Magnitudes and Units, C61, under the procedure of the American Standards Association, 70 E. 45th St., New York, N. Y.

Cooperative Research Program Announced

A PROGRAM by which Philco Corp. will join Massachusetts Institute of Technology in many fields of scientific research useful both to national defense and to the civil-

OVERLAY **TUBING** **STRIPE** **WIRE**

The Finest of Laminated Materials . . .

We are providing manufacturers with a complete line of precious metals laminated to non-precious base metals made to their exact specifications within the following limitations:

SHEET STOCK: Maximum width—5"
Minimum width— $\frac{1}{4}$ "
Thickness—down to .003"

TUBING: Maximum diameter 1" x .050" wall

WIRE: All sizes down to .0045" diameter also squares, rectangular and odd shapes.

In addition to laminated materials we also furnish alloyed gold and silver in sheet, wire or tubing form.

The many varied applications of our materials cannot be listed here, but you are cordially invited to inquire for information regarding your requirements.

The Home of IMPROVED Service

The IMPROVED SEAMLESS WIRE COMPANY
INCORPORATED 1898
775 Eddy Street, Providence 5, Rhode Island

Another
**PRECISION
PRODUCT**

JUST PLAIN
RUGGED
... yet an
instrument of
highest QUALITY
... PRECISION
... ACCURACY

**FOLLOW THE
PARADE
TO THE *New*
Burlington
Hermetically Sealed
INSTRUMENT**



The Burlington "Hermetically Sealed" Instrument was designed and is manufactured to conform to JAN specifications for sealed instruments.

- Steel case with heavy copper-cadmium plate and black finish.
- Excellent shielding due to case material and construction.
- Double strength clear glass.
- Black satin onodized aluminum bezel.
- Glass to metal seal under controlled humidity and temperature conditions.
- D'Arsonval permanent magnet type movement for DC applications.
- Designed to enhance panel appearance.
- Available in 1½" square, 2½" and 3½" round case types.
- Guaranteed for one year against workmanship and materials.

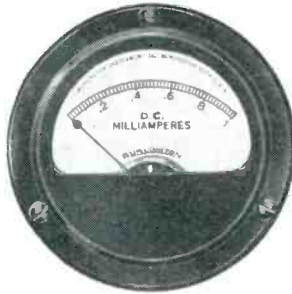

Best Buy Burlington

BURLINGTON INSTRUMENT COMPANY
DEPT. F-71, BURLINGTON, IOWA

SAND & DUST TESTS

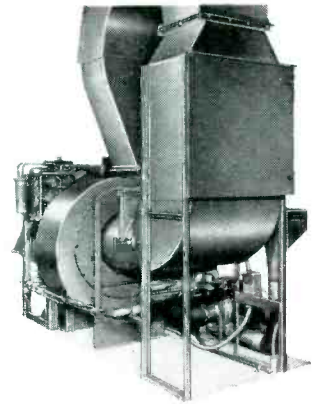

Bowser Sand and Dust Chambers provide facilities for testing aircraft and electronic components in compliance with all MIL, JAN, USAF, AN and other testing specifications. Testing is done in air-suspended sand and dust at high and low air velocities. Temperature control of the air is accurately provided.

Bowser also manufactures engineered environmental equipment for testing, processing and storage in a wide range of sizes and performance ratings. Take advantage now of Bowser's long continuous experience.

**CHECK THE SPEC
YOU HAVE TO MEET**

BOWSER TECH. REFRIG., Terryville, Conn.
Send me more information on the following:

- | | | | |
|-------------------------|--------------------------|-------------------------|--------------------------|
| Walk-in Chambers | <input type="checkbox"/> | High Altitude Tests | <input type="checkbox"/> |
| High Temp. Tests | <input type="checkbox"/> | Mildew Resistance Tests | <input type="checkbox"/> |
| Low Temp. Tests | <input type="checkbox"/> | Sand & Dust Tests | <input type="checkbox"/> |
| Fungus & Humidity Tests | <input type="checkbox"/> | Explosion Proof Tests | <input type="checkbox"/> |

Name _____ Pos _____

Company _____

Street _____

City _____ Zone _____ State _____

BOWSER
TECHNICAL REFRIGERATION
DIVISION BOWSER INC.
TERRYVILLE • CONN.

Only with **CO-A-X**
air-spaced articulated
R.F. CABLES
4mmf/ft



Patents Regd Trade Mark

**THE LOWEST EVER
CAPACITANCE OR
ATTENUATION**

We are specially organized
to handle direct enquiries
from overseas and can give

IMMEDIATE DELIVERIES FOR U.S.A.
Billed in Dollars Settlement by your check.
Transaction as simple as any local buy.

TRANSRADIO LTD
CONTRACTORS TO H.M. GOVERNMENT
138A CROMWELL ROAD - LONDON SW7 ENGLAND
CABLES: TRANSRAD. LONDON.

LOW ATTEN TYPES	IMPED OHMS	ATTEN db/100ft at 100 Mc/s.	LOADING AW	O.D."
A 1	74	1.7	0.11	0.36
A 2	74	1.3	0.24	0.44
A 34	73	0.6	1.5	0.88
LOW CAPAC TYPES	CAPAC mmf/ft.	IMPED OHMS	ATTEN db/100ft 100 Mc/s.	O.D."
C 1	7.3	150	2.5	0.36
PC 1	10.2	132	3.1	0.36
C11	6.3	173	3.2	0.36
C 2	6.3	171	2.15	0.44
C22	5.5	184	2.8	0.44
C 3	5.4	197	1.9	0.64
C33	4.8	220	2.4	0.64
C44	4.1	252	2.1	1.03

**HIGH POWER
FLEXIBLE**

**PHOTOCELL
CABLE**

V.L.C. ★

★ Very Low Capacitance
cable.

**MOLDITE
RF FILTER
CORES**

*... when it's a
matter of the absolute
in precision design!*

**Specify
"CORES BY
MOLDITE"**

Whether it's a filter for electronic controls, actuators, motors, or generators — from 14 KC to 1,000 MC—MOLDITE core specialists are compounding the mix, establishing the design to meet every RF filter core requirement. Years of MOLDITE know-how assure volume production, on time, with absolute sustained accuracy. Let us show you how MOLDITE can help you meet your defense contract specifications, too!

NATIONAL

MOLDITE

COMPANY

1410 Chestnut Ave., Hillside 5, N. J.

Samples promptly
submitted upon request
for design, pre-production,
and test purposes
SEND FOR CATALOG 108

Jerry Golten Co.
2750 W. North Ave.
Chicago 22, Ill.

Martin P. Andrews
Mott Road
Fayetteville, N. Y.

Perlmuth-Colman & Associates
1335 South Flower
Los Angeles, Cal.

Jose Luis Pontet
Cardoba 1472
Buenos Aires

ian economy was recently announced.

Both Philco and the Institute have cooperated for the past 10 years in a program of training engineers, in many forms of electronic development work and in the exchange of technical information. Under the new agreement both will exchange information on research results in a variety of fields. Military and commercial electronics, television and radio are among the subjects of joint interest.

The program also calls for special conferences and seminars, an exchange of visits by MIT and Philco executive and technical personnel, use of scientific libraries and a joint policy to cover inventions and patents.

BUSINESS NEWS

CANNON ELECTRIC Co., is the new name of the Cannon Electric Development Co., Division of Cannon Mfg. Corp., Los Angeles, Calif., manufacturers of plugs and signal equipment.

KEYSTONE CARBON Co., St. Marys, Pa., has recently completed the addition of 20,000 sq ft of floor space for the manufacture of powdered metal parts and negative-temperature-coefficient resistors.

PHILCO CORP. has purchased three new plants in Bedford, Ind., about 65 miles southwest of Indianapolis. This will add about 175,000 sq ft to the company's overall manufacturing facilities of 4,200,000 sq ft.

RAYTHEON MFG. Co., Newton, Mass., has announced plans for the erection of a new plant in Quincy, Mass., by the Receiving Tube Division of the company. The 86,000-sq ft plant will be devoted exclusively to the manufacture of subminiature-type electronic tubes.

WESTINGHOUSE ELECTRIC CORP. has purchased 75 acres on a corner of the Baltimore Friendship airport to build a plant for the production of automatic computers to direct gun and rocket fire, radar and autopilots for fighter planes and guided missiles, and complete airborne ar-

GET THE FACTS ON *Potter* HIGH SPEED ELECTRONIC PREDETERMINED COUNTERS

For these applications:

- AUTOMATIC MACHINE CONTROL
- PACKAGING BY PREDETERMINED COUNT
- LINEAL MEASUREMENTS
- FREQUENCY MEASUREMENTS
- TIME INTERVAL CONTROL



The **ONLY** counter
with **ALL** these features!

- COUNTS AT RATES UP TO
60,000 PER MINUTE
- ABSOLUTE ACCURACY
- INSTANTANEOUS AUTOMATIC RESET
- NO MOVING PARTS,
FRICTION OR INERTIA
- SIMPLE DIAL SELECTION OF COUNT

Potter Predetermined Electronic Counters extend the field of automatic counting and control far beyond the scope and capabilities of existing mechanical and electromechanical devices. There are no moving parts, therefore, wear, slippage and inertial effects are eliminated.

Although the standard models count at rates up to 60,000 per minute, counters capable of counting at higher rates are available.

A complete line of photoelectric and electromagnetic detectors, for counting any material or action, can be supplied.

The instruments are easily applied to any problem requiring the precise measurement or control of QUANTITY, LENGTH, TIME, FREQUENCY, REVOLUTION or CAM SEQUENCE. Absolute accuracy of count is guaranteed.

Write today for an accurate appraisal of your problem to Dept. 6-B.

**POTTER
INSTRUMENT CO.**
INCORPORATED



115 CUTTER MILL RD., GREAT NECK, NEW YORK

All types of **AGASTAT** TIME DELAY RELAYS

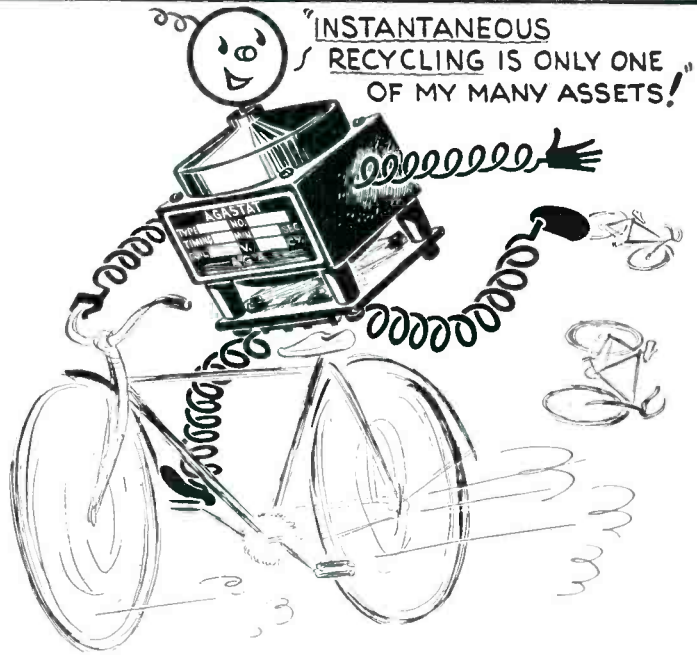

are solenoid actuated — pneumatically timed. For AC and DC service. It will pay you to take time out to investigate Agastat Time Delay Relays. Information and literature on request.



AMERICAN GAS ACCUMULATOR COMPANY
1027 NEWARK AVENUE • ELIZABETH 3, N. J.

the right combination

AiResearch Rate
of Change
Control

FOR THE RIGHT CABIN PRESSURE



The AiResearch Rate of Change Control regulates the rate at which pressure in the airplane's cabin changes. An A. W. Haydon Motor was chosen to drive the instrument because of its proved performance record in scores of important aircraft applications. Other functions for which similar A. W. Haydon Motors are used include controls for wing and propeller de-icing, propeller feathering, camera intervalometer, hydraulic bypass, fuel tank purging as well as recorder chart drives, trim control, telemetering and destructor control, etc.

Send for
complete catalog.

A. W. Haydon
Standard D.C. Tim-
ing Motor No. 5301

The
A.W. HAYDON
COMPANY
235 NORTH ELM STREET
WATERBURY 20, CONNECTICUT
Design and Manufacture of Electrical Timing Devices

NEW G-E LAMP

Controls

Objectionable

Odors!



This new G-E Ozone Lamp emits ultraviolet energy that creates ozone. Ozone chemically destroys or masks many disagreeable odors and substitutes the fresh smell of outdoors.

Extra Sales for Your Product

The tiny 4-watt size makes it easy to design into your product—adding to its value and appeal.

Among its useful applications are:

Public Rest Rooms	Clothes Dryers	Air Conditioners
Kitchens and Bathrooms	Refrigerators	Beverage Vendors

As the Ozone Lamp has a mild germicidal effect, it may be used in small sanitary storage cabinets.

To use the ozone lamp a ballast is required. For complete information on this amazing new lamp, write or phone your nearest General Electric Lamp office.

You can put your confidence in—

GENERAL ELECTRIC

mament systems. The new 400,000-sq ft plant is expected to be completed by autumn.

ZENITH RADIO CORP. has begun excavation on its new 453,000-sq ft plant at 1500 N. Kostner Ave., Chicago, Ill. The plant will be used for manufacturing components and the assembling and testing of electronic equipment for the military services.

NATIONAL ELECTRONIC MFG. CORP., Long Island City, N. Y., manufacturers of quartz crystals, crystal holders and other electronic parts during World War II, has resumed production of these items to meet current military demand.

THE WORKSHOP ASSOCIATES, INC., Needham, Mass., recently became a wholly-owned subsidiary of The Gabriel Co., Cleveland, Ohio.

LISTON-FOLB, Div. of Atlas Coil Winders, has now incorporated as Liston-Folb Instrument Co., Inc., and has moved into new quarters at 20 Beckley Ave., Stamford, Conn., thus expanding facilities for production of d-c breaker amplifiers and other special electronic equipment.

JERROLD ELECTRONICS CORP., manufacturer of multiple tv antenna systems, has expanded production and laboratory facilities by moving to new plant space at 26th and Dickinson Sts., Philadelphia, Pa.

MCCORMICK SELPH ASSOCIATES, designers and manufacturers of glass-to-metal seals for guided-mis-



sile and other specialized applications, have moved from Belmont, Calif., to new quarters in Palo Alto, Calif.

ANDERSEN LABORATORIES, INC., West Hartford, Conn., has taken over the business and personnel of

2 KW VACUUM TUBE BOMBARDER OR INDUCTION HEATING UNIT



For Only \$650.

Never before a value like this new 2-KW bench model "Bombarder" or high frequency induction heater . . . for saving time and money in surface hardening, brazing, soldering, annealing and many other heat treating operations.

Simple . . . Easy to Operate . . .
Economical Standardization of
Unit Makes This New Low Price
Possible.

This compact induction heater saves space, yet performs with high efficiency. Operates from 220-volt line. Complete with foot switch and one heating coil made to customer's requirements. Send samples of work wanted. We will advise time cycle required for your particular job. Cost, complete, only \$650. Immediate delivery from stock.

Scientific Electric Electronic Heaters are made in the following ranges of Power: 1-2-3½-5-7½-10-12½-15-18-25-40-60-80-100-250KW.

*Scientific
Electric*

Division of

"S" CORRUGATED QUENCHED GAP CO.

107 Monroe St., Garfield, N. J.

CHOOSE the right STANLEY IRON for every job

CHECK THESE IMPORTANT FEATURES

- ✓ Heating head sealed at working end, protects against flux fumes.
- ✓ Uniform flow of heat for continuous soldering.
- ✓ Balanced for easy handling.
- ✓ Pure copper replaceable tips.
- ✓ Cord strain relief.
- ✓ An iron for every purpose.
- ✓ Choice of screw-in or plug-in tips.
- ✓ Available in standard voltages.
- ✓ Armor Clad Tips available for all sizes of irons — last 3-10 times longer on production soldering



SEND for this NEW helpful folder on Stanley Electric Soldering Irons and Armor Clad Tips. FREE →

STANLEY TOOLS, NEW BRITAIN, CONN.
THE TOOL BOX OF THE WORLD



STANLEY

Reg. U.S. Pat. Off.

HARDWARE • TOOLS • ELECTRIC TOOLS • STEEL STRAPPING • STEEL



HEAT RESISTANT WIRES FOR EVERY APPLICATION . . .

So — you think
this is
HOT

Well for you or me it's hot enough, but for Lewis heat resisting insulated wire it isn't even a starter.

Toasters, waffle irons, stoves and on up to include jet engines—that's where Lewis wire is doing its job day after day without complaint. Does your wire problem involve hot spots?

HEATING UNITS
HEATING ELEMENT
RESISTANCE
LINE CORD
THERMOCOUPLE WIRE
ASBESTOS LEAD
& FIXTURE WIRE
INSULATED
RESISTANCE WIRE
FIBERGLAS
INSULATED WIRE
WIRE TO ANY
SPECIFICATIONS

Send your electronic control, communications or appliance wiring specifications for a recommended solution by our engineers.

FOR A TRIAL ORDER OR A CARLOAD consult



THE LEWIS ENGINEERING CO.

Wire Division

NAUGATUCK CONNECTICUT

SPACE SAVERS!



JOHNSON MINIATURE AIR VARIABLE CONDENSERS

Today's modern equipment demands a compactness not believed practical a few years ago.

To meet today's demands for a condenser the size of a penny, JOHNSON designed these miniature air variables — the smallest air variables ever built!

Here are **real** space savers, both in front of and behind the panel. Ceramic plates measure only 5/8" wide by 3/4" high!

In spite of their extremely small size, these diminutive condensers, accurately produced to close tolerances, are as precisely and carefully built as a fine watch . . . are completely dependable.

Three types are available: The customary Single Section, a Differential and a Butterfly.

These tiny condensers are unequaled for TV and FM applications, laboratory and test equipment, military and other communications, and in a multitude of VHF and UHF uses where compactness and peak performance are demanded.

FEATURES

- Split sleeve bearings and soldered plate construction insure perfect alignment even during rigorous portable-mobile service.
- Beryllium copper contact-tension spring guarantees permanent peak performance.
- Single hole mounting bushing threaded 1/4-32, with flats to prevent turning.
- Voltage breakdown 1250 V peak.
- Steatite insulation treated with DC-200 for maximum moisture resistance.
- Nickel-plated brass plates spaced .017"
- Improved stator terminal.
- 3/16" shaft, slotted for screw driver adjustment.

Cat. No.	SINGLE mmf	
	Max.	Min.
5M11	5.0	1.5
9M11	8.7	1.8
15M11	14.2	2.3
20M11	19.6	2.7

Cat. No.	DIFFERENTIAL mmf	
	Max.	Min.
6MA11	5.0	1.5
9MA11	8.7	1.8
15MA11	14.2	2.3
19MA11	19.6	2.7

Cat. No.	BUTTERFLY mmf	
	Max.	Min.
3MB11	3.1	1.5
5MB11	5.1	1.8
9MB11	8.0	2.2
11MB11	10.8	2.7

JOHNSON miniature air variables are available in production quantities with special features such as: 1. Locking bearing, illustrated at left, 2. With 180° stop, 3. Various shaft extensions, 4. .0135" spacing offering capacities up to 30 mmfd., 5. High torque.

You are invited to submit your engineer's specifications and quantity desired. We will be happy to quote prices.

JOHNSON Catalog 701, yours for the asking, describes this miniature line as well as other JOHNSON variable condensers.

MODIFICATIONS
AVAILABLE ON SPECIAL
ORDER

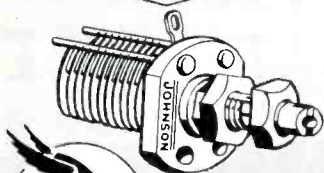

JOHNSON . . . a famous name in Radio!
E. F. JOHNSON CO., WASECA, MINNESOTA

the Andersen-Shaw Laboratories and is continuing research and development work in the ultrasonic field. In addition the new company is manufacturing ultrasonic delay lines and ultrasonic generators.

PERSONNEL

W. B. WHALLEY, engineering specialist for Sylvania Electric Products Inc., Bayside, N. Y., was recently appointed adjunct professor in electrical engineering for the Polytechnic Institute of Brooklyn.

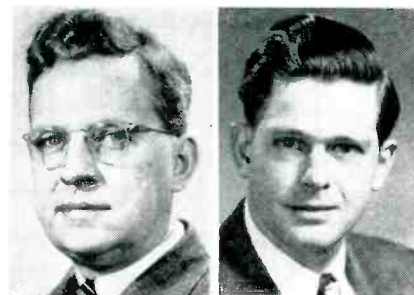

W. B. Whalley

L. C. Kunz

LOUIS C. KUNZ was recently promoted from section engineer on c-r tubes at GE's Electronics Park to product manager for c-r tubes in the company's tube division, with headquarters at Schenectady, N. Y.

EMANUEL R. PIORE, formerly deputy for natural sciences at the Office of Naval Research, Washington, D. C., has been appointed deputy chief of research and chief scientist of the ONR.

FREDERICK N. JACOB, formerly chief engineer of Aladdin Radio Industries, Inc., has joined Belmont Radio Corp., Chicago, Ill., as products manager for infrared equipment.

EUGENE F. GRANT, former chief of the Computer Branch at Air Force Cambridge Research Laboratories, has been appointed to the post of coordinator of electronics research and development for the W. L. Maxson Corp., New York, N. Y.

GEORGE H. PHELPS, formerly associated with RCA Victor, was recently appointed chief engineer of Hammarlund Mfg. Co., Inc., New York City, manufacturers of commercial receivers, selective calling

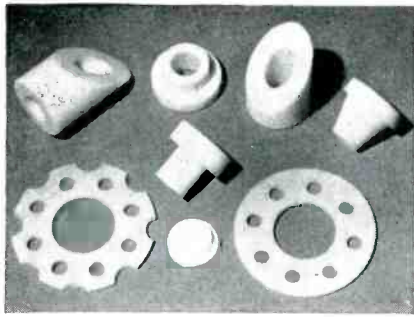

"TEFLON" A PLASTIC
HAS OUTSTANDING ELECTRICAL
PROPERTIES

• It's power factor is less than 0.05% over the entire spectrum measured to date, 60 cycles to 30,000 megacycles. Its volume resistivity is greater than 10^{15} ohm-cm. even after prolonged soaking in water. The surface resistivity of the plastic is quite high and drops to only 10^{13} ohms at 100% relative humidity. "Teflon" also shows good arc resistance. On exposure to an arc, the material is decomposed to a vapor which leaves no carbonized path regardless of time of exposure to the arc. Short time dielectric strengths are high. These values range from 1000 to 2000 volts per mil., depending on thickness. "Teflon" is almost as good in this respect at 200°C (392°F) as at room temperature.

We have complete manufacturing facilities to mold "Teflon" for your application in the following shapes:

- Tapes
- Special Molded Shapes
- Tubes
- Sheets
- Packing Sets
- Gaskets Plain and Envelope
- Rods

SEND FOR CATALOGUE 711

John L. Dore Inc.

MOLDERS OF "TEFLON" SHAPES

P. O. BOX 6002

5406 Schuler St. Houston 6, Texas

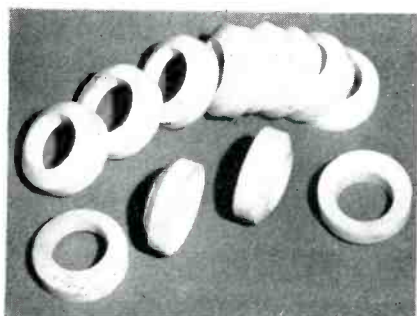

Special TRANSFORMERS by NOTHELPER

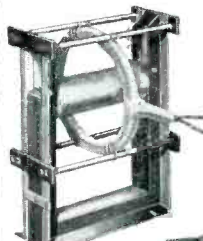
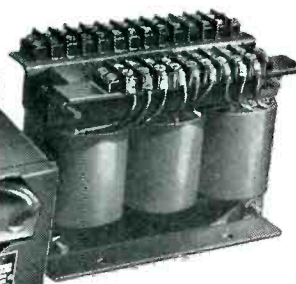



Proven by
Past
Performance

We are now working at the highest capacity in our history. We intend to do our best to protect the interests of our many customers—not of just a chosen few, but of all those who are regular buyers of Nothelfer Transformers. We ask your patience and understanding under present abnormal conditions.



NOTHELPER
WINDING LABORATORIES
9 ALBEMARLE AVE., TRENTON 3, N. J.



New BIRTCHER TUBE CLAMP FOR MINIATURE TUBES

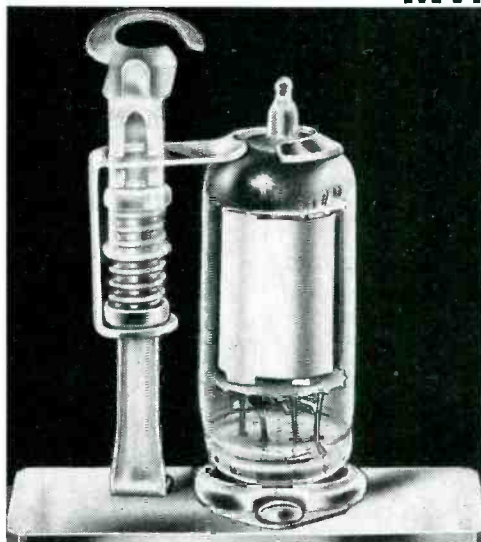

**POSITIVE PROTECTION
AGAINST LATERAL AND
VERTICAL SHOCK!**

The *New* Birtcher Type 2 Tube Clamp holds miniature tubes in their sockets under the most demanding conditions of vibration, impact and climate. Made of stainless steel and weighing less than 1/2 ounce, this *New* clamp for miniature tubes is easy to apply, sure in effect. The base is keyed to the chassis by a single machine screw or rivet...saving time in assembly and preventing rotation. There are no separate parts to drop or lose during assembly or during use. Birtcher Tube Clamp Type 2 is

all one piece and requires no welding, brazing or soldering at any point.

If you use miniature tubes, protect them against lateral and vertical shock with the Birtcher Tube Clamp (Type 2). Write for sample and literature.

Builder of millions of stainless steel Locking Type Tube Clamps for hundreds of electronic manufacturers.

The **BIRTCHER Corporation**

5087 HUNTINGTON DRIVE • LOS ANGELES 32

ECLIPSE-PIONEER

Announces the New Line of

PYGMY SYNCHROS

Size of pygmy
as compared
to AY-200
series outline

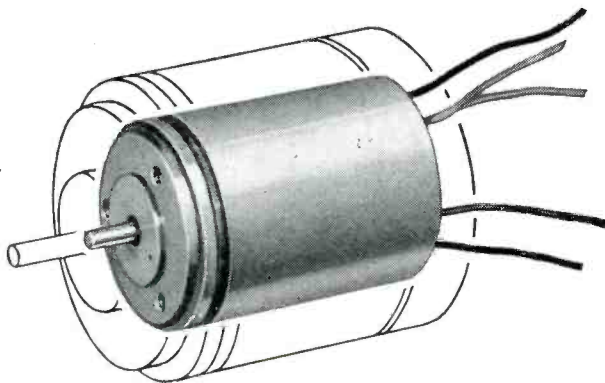

Eclipse-Pioneer has added a tiny new member to its great family of famous Autosyn* synchros. It's the new AY-500 series, a precision-built pygmy weighing only 1 $\frac{3}{4}$ oz. while scaling only 1.278" long and .937" in diameter (the same diameter, incidentally, as a twenty-five cent piece). Its accuracy and dependability are assured, thanks to Eclipse-Pioneer's 17 years of experience and leadership in the development of high precision synchros for aircraft, marine and industrial applications. For more detailed information on the AY-500 and other E-P Autosyns, such as the remarkably accurate AY-200 series (guaranteed accuracy to within 15 minutes on all production units), please write direct to Eclipse-Pioneer, Teterboro, N. J.

*REG. TRADE MARK BENDIX AVIATION CORPORATION

LOOK FOR THE PIONEER MARK OF QUALITY
REG. U.S. PAT. OFF.

Typical Performance Characteristics

	One AY-201-3 Driving		One AY-500-3 Driving
	One AY-500-3 Control Transformer	Two AY-500-3 Control Transformer	One AY-500-3 Control Transformer
INPUT			
Voltage	26-volts, single-phase	26-volts, single-phase	26-volts, single-phase
Frequency	400 cycles	400 cycles	400 cycles
Current	88 milliamperes	110 milliamperes	55 milliamperes
Power	0.8 watts	1.2 watts	0.9 watts
Impedance	105 + j280 ohms	100 + j220 ohms	290 + j370 ohms
OUTPUT			
Voltage Max. (rotor output)	17.9 volts	16.2 volts	14.1 volts
Voltage at null	40 millivolts	40 millivolts	40 millivolts
Sensitivity	310 millivolts/degree	280 millivolts/degree	245 millivolts/degree
Voltage phase shift	23 degrees	26 degrees	44 degrees
System accuracy (max. possible spread)	0.6 degrees	0.6 degrees	0.75 degrees

Other E-P precision components for servo mechanism and computing equipment:

Servo motors and systems • rate generators • gyros • stabilization equipment • turbine power supplies • remote indicating-transmitting systems and special purpose electron tubes.

For detailed information, write to Dept. C

ECLIPSE-PIONEER DIVISION of

TETERBORO, NEW JERSEY

Export Sales: Bendix International Division, 72 Fifth Avenue, New York 11, N. Y.



and remote control apparatus, variable air capacitors and radar components.

JOSEPH A. IDANK has joined the staff of Parco Design Corp., New York, N. Y., as chief engineer of the Special Devices Division where he will direct research, development and engineering on precision mechanical and electronic devices and instruments for use on highly specialized industrial and Armed Services projects.

H. B. FANCHER, with General Electric Co. since 1936, has been promoted to division engineer of commercial products for the company's Commercial Equipment Division, Syracuse, N. Y.



H. B. Fancher



R. H. Dorf

RICHARD H. DORF, former audio and tv systems consultant, has joined the staff of Brach Mfg. Div. of General Bronze Corp. as electronics project engineer. He will take charge of the company's government electronics projects.

JOHN J. FARRELL, formerly engineer in charge of commercial products for General Electric Co.'s transmitter division, has been appointed assistant manager of engineering for the company's commercial equipment division.

REX WILSON, formerly chief engineer of Tele-Vogue, Inc., Chicago, Ill., has been elected vice-president in charge of engineering for the company.

W. G. HENKE, formerly test equipment design engineer of Admiral Corp., has joined Tele-Vogue, Inc., as coordinator of engineering.

E. B. STEINBERG, previously affiliated with Remington Rand Inc., is now associated with The Reflectone

SELENIUM RECTIFIERS

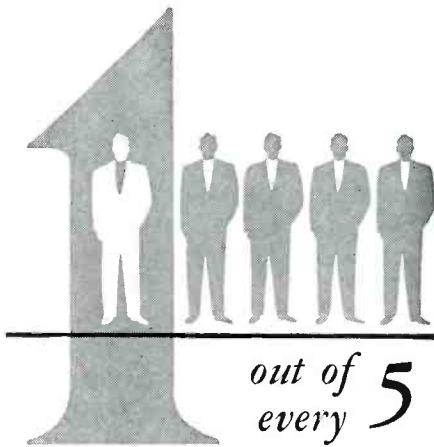

1 out of every 5

Here at International Rectifier Corporation, we take our engineering seriously. As a result, one out of every 5 of our employees is a carefully trained, graduate engineer. That means intelligent control of quality from design to finished product. That also means, when you specify International R. C. Rectifiers, you get peak performance and long life.

You can put this engineering organization to work for you without adding one cent to your payroll. International R. C. engineers will cooperate with your staff in developing the correct Rectifier for your job and in producing them in the quantity you need.

TYPE W-HS-SERIES 75 Milliamperes DC

In 1 1/4" Phenolic Tube with stud mounting at each end. Circuit-Half-Wave. Overall length varies to 14", depending on DC Output Voltage rating. For many applications for heavier duty and inverse peak suppressor circuits.

Type W248HS
4960 Volts DC Output
75 ma. Overall length, 13".

OVER 500
TYPES
FOR EVERY
SPECIAL
NEED

DESIGNED TO MEET DIFFICULT HUMIDITY, ALTITUDE, VIBRATION AND SHOCK SPECIFICATIONS.

PARTIAL LISTING W-HS SERIES

DC Output Voltage	Rectifier Part No.
20	W1HS
60	W3HS
100	W5HS
400	W20HS
800	W40HS
1500	W75HS
2500	W125HS
3500	W175HS
4500	W225HS
6000	W300HS

When you put your rectifier problems up to International Rectifier Corporation, you not only get peak performance, you get dependability and long life. Write for further data and literature.

INTERNATIONAL RECTIFIER CORPORATION

6809 S. VICTORIA AVE • LOS ANGELES 43

Originally Designed by
**WINCHESTER
ELECTRONICS
INCORPORATED**

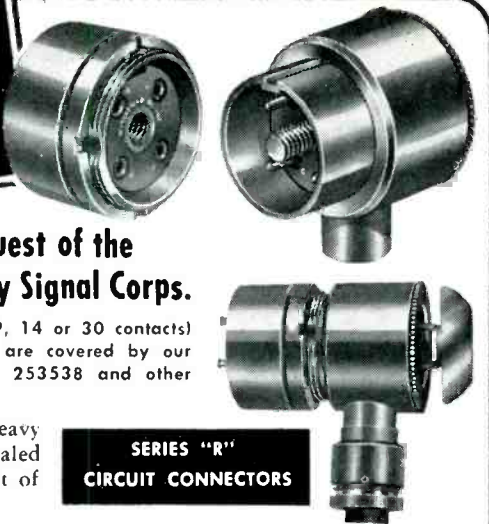

...at the specific request of the
United States Army Signal Corps.

The series "R" circuit connectors (4, 9, 14 or 30 contacts) have several unique features which are covered by our patent Nos. DES 161900, 2513080, 253538 and other patents pending:-

1. Mechanically protected for heavy duty use by means of pressure sealed metal shells. (Screw for engagement of plug and receptacle is enclosed).
2. Water and pressure tight sealing by use of individual seal rings between each contact and insert and between insert and shell.
3. Method for adjusting orientation of cable entry fitting.
4. Central double-lead lock screw (with bale) for positive engagement and

**SERIES "R"
CIRCUIT CONNECTORS**

disengagement, assurance against accidental disconnection, grounding means for metal shell and shell cap, reduction of space as required by other types of metal shells.

Write our Engineering Department for technical service or for details on our standard circuit connectors.

**Winchester Electronics
INCORPORATED**
GLENBROOK, CONNECTICUT, U.S.A.

now...
LABORATORY CONTROL

ASSURES



PRECISION COIL BOBBINS

**With Better Insulation,
Moisture-Resistance and
Heat-Dissipation**



Strict Laboratory Control of Materials enables Precision to offer you bobbins that are 15 to 20% stronger, yet light in weight—that have greater insulation, moisture-resistance and heat-dissipation, too. Increased coil winding space is another vital feature of Precision Coil Bobbins.

Flanges furnished with leads, slots, holes or plain—all types supplied flat, recessed or embossed to fit any mounting. Tube ends swaged to lock flanges. Any size, any shape available—round, square, rectangular—in dielectric Kraft, Fish Paper, Cellulose Acetate or combinations.

Send Specifications for Sample and Ask for New Mandrel List of 1000 sizes.

PRECISION PAPER TUBE CO.

2041 W. Charleston St.
Chicago 47, Ill.

Plant No. Two, 79 Chapel St., Hartford, Conn.

Also Mfrs. of Precision Paper Tubes

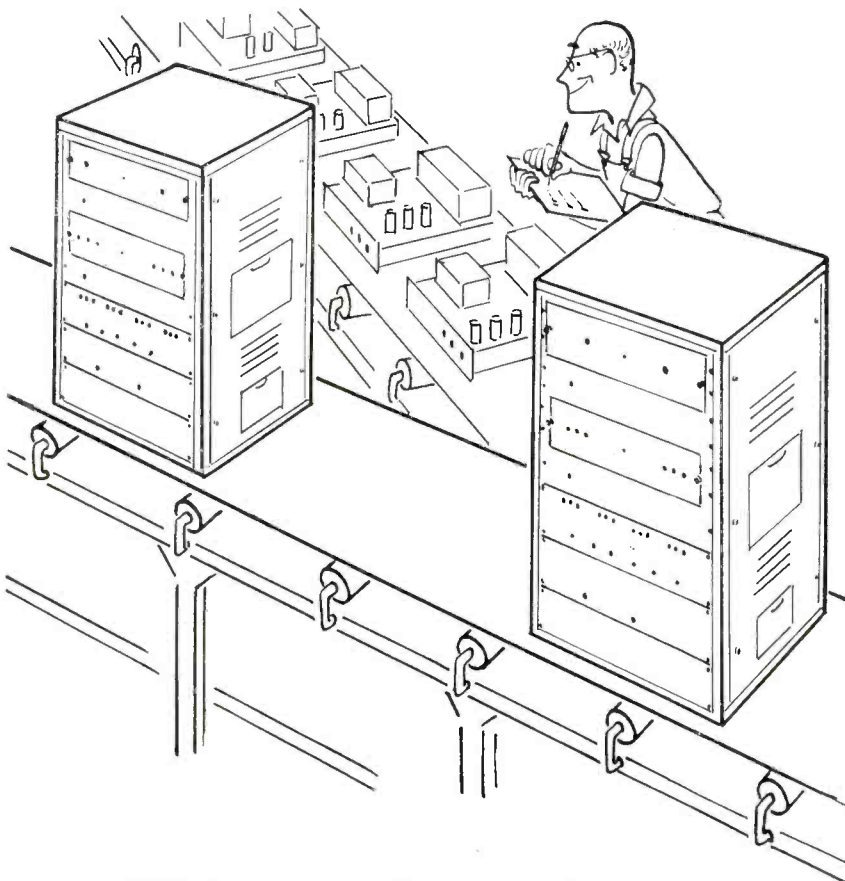

We're ready to tie our Production line into yours!

If you need top-quality metal cabinets, housings, chassis or complete assemblies for your defense production, we're ready to figuratively extend our efficient production lines right into your plant! We have over 30 years of experience fabricating steel, stainless steel and aluminum . . . the latest time-saving metal working equipment . . . skilled craftsmanship . . . and a staff of highly specialized engineers who know how to translate your specifications into prompt deliveries. We're ready right now to sit down with you over your blue prints . . . or to send you detailed information showing how Corry-Jamestown can help you.

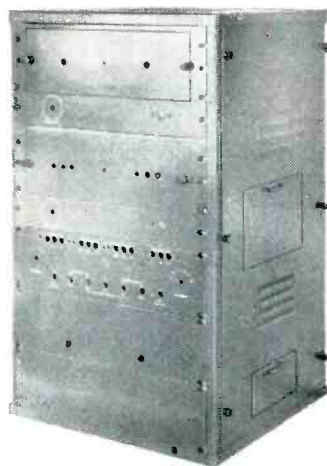

CALL, WRITE OR WIRE US TODAY!

CORRY-JAMESTOWN MFG. CORP.

CORRY, PENNSYLVANIA

Makers of famous Steel Age office furniture

Corp., Myano Lane, Stamford, Conn., as engineer in charge of its science division.

HAROLD W. GIESECKE, recently promoted to assistant to the general manager of Bendix Radio Division of Bendix Aviation Corp., had been previously associated with Westinghouse Electric Corp. Pittsburgh, Pa.

ADOLPH H. ROSENTHAL, inventor of the Skiatron dark-trace c-r tube, has been elected vice-president and director of research and development of Freed Radio Corp., New York, N. Y.



A. H. Rosenthal

J. D. Schantz

JOSEPH D. SCHANTZ has been promoted from assistant chief to chief engineer of Bell Aircraft Corp., Buffalo, N. Y. As a member of the Radio Technical Planning Board No. Six, he had helped to develop the code of tv standards in use today.

JOSHUA SIEGER of White Plains, N. Y., a member of the technical committees of RTMA and NTSC, will now act as an independent technical consultant in the fields of radar, communications and television.

ROBERT M. ULMER of Cleveland, Ohio, has joined Horizons Inc., of the same city, as a laboratory assistant.

CURTIS B. PLUMMER, formerly chief engineer, has been named head of the new Broadcast Bureau of the Federal Communications Commission.

LEON HILLMAN, previously with New York University's Research Division, was recently appointed head of the engineering department of Production Research Corp.,

Brush
presents
**MAGNETIC
RECORDING
RUBBER**
synthetic



- Recording medium of amazing versatility
- Practically no wear factor, either to recording head or magnetic medium
- Permanently self-lubricating
- For sound and pulse recording

RECORDING COMPONENTS

Brush makes a full line of magnetic recording components, from single, wafer-thin, to multichannel heads. For information about stock or made-to-specification magnetic recording components, write



**THE BRUSH
DEVELOPMENT
COMPANY**

3405 PERKINS AVENUE
CLEVELAND 14, OHIO

"Our business is the future"

**PRECISION
POTENTIOMETERS**

Various types of potentiometers custom wound to specifications are available. They feature extremely close limits in electrical characteristics and mechanical construction, low electrical noise, low torque, and long life.

All types will operate within specified limits of performance at temperatures -55°C . to $+55^{\circ}\text{C}$., 95% relative humidity at altitudes up to 50,000 feet. Corrosion resistant materials are used throughout and all insulating parts are fungicided. Our potentiometers meet AN-E-19 specifications.

We invite your inquiries and specifications.

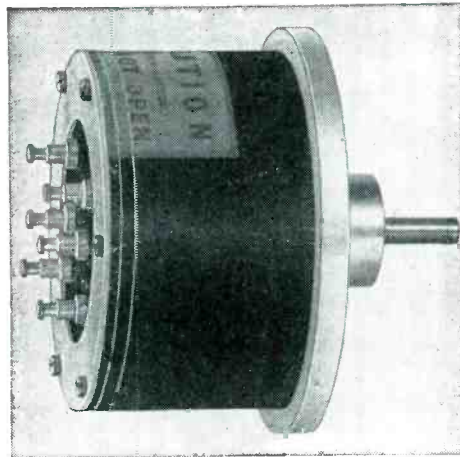

A minor modification of the standard sinusoidal potentiometer type RL-11-C (as illustrated) permits operation up to 1800 RPM. After a test of 28 million cycles at 1800 RPM, one of these units showed negligible wear.

Write for Bulletin F-68

THE GAMEWELL COMPANY
Newton Upper Falls 64, Massachusetts



**FOR POSITIVE AND
INEXPENSIVE SHIELDING**

— use Metex "Electronic Weather Strips"

Because they combine exceptional *resiliency* with good *conductivity*, Metex Electronic Products made of knitted wire mesh offer an unusually effective means of sealing and shielding a wide variety of types of electronic equipment.

As closures for sheet metal cabinets, for instance, the resiliency of "Metex" assures positive conductive contact at every point between cover and cabinet — eliminating costly machining for close tolerances. Metex Gaskets also assure resilient metal-to-metal contact between flanges, and can be combined with rubber com-

pounds to function both as a shield and as a seal.

Applications in which "Electronic Weather Strips" have already proved their effectiveness include pulse modulator shields, wave-guide choke-flange gaskets, replacement of beryllium-copper fingers and springs on TR and ATR tubes.

We will be glad to put our experience at your disposal. A letter to Mr. R. L. Hartwell, outlining your problem, will receive immediate study.

For preliminary information, write for bulletin "Metex 'Electronic Weather Strips.'"



METAL TEXTILE CORPORATION

641 EAST FIRST AVENUE, ROSELLE, N. J.

HOUSINGS

for the

ELECTRONICS INDUSTRY

Your choice of height in more than 44 panel sizes, designed to afford greatest utilization of space and weight . . . Streamlined appearance . . . Sturdy . . . Economical . . . Olympic "S" series, "A" series and MIL-T-27 series, with or without snap locks, shipped from stock.

for
relays
vibrators
amplifiers
capacitors
instruments
transformers

Case bodies fabricated to any length required. Hot tin dipped to your specifications. Covers and cases modified with hole patterns, cut-outs, mounting brackets or other special requirements.



Facilities available for fabrication of sub-assemblies.

OLYMPIC

METAL PRODUCTS COMPANY INC.

P. O. Box 71A

Phillipsburg, N. J.

Thornwood, N. Y., specialists in research, development and production of electronic equipment for the Armed Forces.

DEVEREAUX MARTIN, formerly chief engineer at Radio Receptor Co., Inc., Brooklyn, N. Y., has been named assistant to the president, to work on special assignments, particularly in the field of new-product exploration.

JOSEPH B. HERSH, with the Utility Electronics Corp., Newark, N. J., for the past three years, has been named executive vice-president and general manager of the company. He was formerly chief engineer with the David Bogen Co., Inc.

L. H. JUNKEN has been promoted from designing engineer to division engineer of engineering services for General Electric Co., commercial equipment division, at Syracuse, N. Y.



L. H. Junken



P. L. Spencer

PERCY L. SPENCER, vice-president in charge of the Power Tube Division of the Raytheon Mfg. Co., Waltham, Mass., was recently awarded priority of invention of basic magnetron strapping by the U. S. Patent Office.

ALFRED C. HAEMER, JR., a member of the National Research and Development Board, has been named head of the field engineering department of General Precision Laboratory, Inc., Pleasantville, N. Y.

GEORGE O. SMITH, author of instruction manuals covering the technical use of sonar, radar and other specialized electronic devices during World War II, was recently appointed manager of components engineering at Emerson Radio and Phonograph Corp., New York, N. Y.



NATIONAL

- **P**roven
- **D**ependable
- **Q**uality

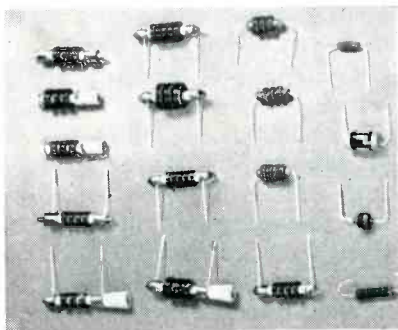

PRECISION-WOUND R.F. CHOKES

National makes a complete line of quality R.F. chokes to meet virtually every electronic need. In addition, National's engineering staff and production facilities are capable of winding chokes to any set of specifications for commercial or military applications. Close tolerances guaranteed. Write for complete catalog or send your specifications.

Write for Drawings.

EXPORT DIV.—DEP'T E 751



MEGOHMS
MEGOHMS
MEG
MEG **Cheaper** by the dozen with
MEGOHMS
MEGOHMS
MEGOHMS
MEGOHMS
MEGOHMS
MEGOHMS

JELLIFF ALLOY 1000 RESISTANCE WIRE

This new material packs 1000 ohms/cmf—48% more than the widely-used nickel-chromium alloys.

And what's more, there's no loss of other important physical and electrical properties. High tensile strength—excellent solderability—TC of Resistance is 20—EFM vs Copper + 7 micro-volts—Coefficient of Expansion 13.9—remarkable Surface-Corrosion Resistance—and many more vital characteristics make ALLOY 1000 a money-making, prestige-building component of compact, precision resistors. For complete data, get Bulletin 17



Cut Your Costs, Too, With **POWRARM** WORK POSITIONERS

HERE'S HOW OTHERS DO IT

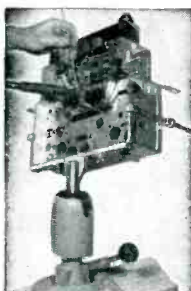

POWRARM cuts costs by increasing every worker's productivity. It gives the worker a powerful *third hand* to hold work while two hands produce. That's why POWRARM works on the most efficient assembly lines in America today, and *belongs on yours*. Write us about your production "head-ache" . . . we'll show you how POWRARM can cure it.

Write For Catalog 101E
32 informative pages, FREE



Holds work at any angle in Horizontal, Vertical or Co-axial Plane.

Three sizes of Powrarm—24 to 150 lbs. capacity.



WILTON TOOL MFG. CO.
Precision Built Bench Vises, "C" Clamps and Work Positioners
925-T Wrightwood Avenue • Chicago 14, Illinois

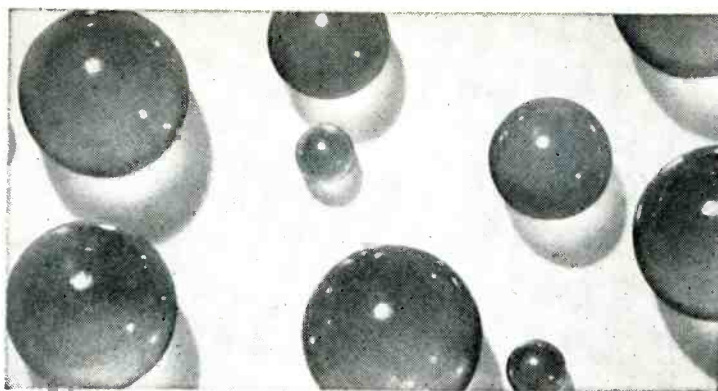

Now PRECISION BALLS of Synthetic Sapphire

Now... the wear, corrosion, and heat resistance of synthetic sapphire in balls polished to within 20 micro-inches of sphericity.

THESE uniaxial spheres resist corrosion or erosion by many acids and alkalis... possess a higher dielectric strength than glass or mica... have a low coefficient of friction and superior hardness. In many applications, they need not be lubricated.

LINDE synthetic sapphire balls are available in 1mm, 1/16 inch, 1/8 inch, and 1/4 inch sizes. Three surface finishes are available: super-finished, semi-finished, and rough-ground blanks.

CALL or WRITE any LINDE office for information on these balls, or the other forms of LINDE synthetic sapphire.

PROPERTIES

Composition.....	Al ₂ O ₃
Coefficient of Friction.....	0.140 (Steel pivot on sapphire ring)
Hardness (Knoop).....	1525—2,000
Modulus of Elasticity in Flexure.....	50—56 x 10 ⁶ psi
Dielectric Constant.....	7.5—10
Modulus of Rigidity.....	21.5—27.5 x 10 ⁶ psi
Thermal Coefficient of Expansion.....	5.0—6.7 up to 50°C (per °C x 10 ⁻⁶)
Chemical Resistance.....	Unaffected by acids, dilute alkali.

LINDE AIR PRODUCTS COMPANY

A DIVISION OF UNION CARBIDE AND CARBON CORPORATION

30 E. 42nd St., New York 17, N. Y.  Offices in Other Principal Cities

In Canada: DOMINION OXYGEN COMPANY, LIMITED, Toronto

The term "Linde" is a trade-mark of Union Carbide and Carbon Corporation.

NEW BOOKS

(Continued from page 150)

drogen phosphate (KDP) and barium titanate. While the treatment is always attentive to theory, the experimenter will find much of value in the substantial amount of practical information on measurement procedure, orientation of cuts and values of physical constants. Of special interest to those who follow theoretical development in this field, will be Dr. Mason's theory on ferroelectricity, more completely presented in this work than in any other writing.

The final three chapters of the book discuss the application and production of ultrasonic waves to measure the properties of gases, liquids and solids. Here too the experimenter will find much of interest in the procedures described, the sketches of equipment and the many graphs and tables of measured data.

It need hardly be said that this work, written by one of the foremost researchers of a laboratory distinguished, among other things, for its contributions to this field is strongly recommended to all who have serious interest in the properties of crystals.—J. F. MCALLISTER, *General Electric Co., Syracuse, New York.*

Vacuum-Tube Voltmeters

BY JOHN F. RIDER. *Second edition, published by John F. Rider Publisher, Inc., New York, 422 pages, \$4.50.*

THE IMPORTANCE of the vacuum-tube voltmeter has been stressed repeatedly. Many engineers, however, overlook some of the less obvious jobs that can be done with vtvm's. It is hard to imagine a person involved in laboratory work who could not discover at least five new ideas from reading Rider's book.

This second edition brings the first (1941) edition up to date. The applications section alone will be worth the price of the book to many. It gives easy-to-follow instructions for measuring such things as inductance, resistance, capacitance, r-f, a-f and d-c voltages and currents with a vtvm. A completely new chapter deals with d-c and r-f probes of all types.

One section is devoted to a comparison of the more than 40 com-

PREMAX

POINT-TO-POINT ANTENNAS FOR CIVIL DEFENSE

Follow the lead of military communications experts and use the easy-to-erect, efficient and economical vertical antennas for those point-to-point frequencies in the 160, 80 and 75 meter bands, plus CAP, MARS and joint disaster channels.

Premax can supply aluminum, stainless steel and steel Antennas at heights up to 35 feet with base and standoff insulators. Also coil-loaded Antennas at 9½ and 17-foot heights which give super-efficiency with smaller size.

Vertical Antennas with their omnidirectional coverage work better with vertically equipped mobiles.

See your distributor or write for Catalog.

PREMAX PRODUCTS
DIVISION CHISHOLM-RYDER CO., INC.

5101 Highland Ave. Niagara Falls, N. Y.

Over 85% of the torque wrenches used in industry are

STURTEVANT

TORQUE WRENCHES

Read by Sight, Sound or Feel.

- Permanently Accurate
- Practically Indestructible
- Faster—Easier to use
- Automatic Release
- All Capacities

in inch ounces . . . inch pounds . . . foot pounds
(All Sizes from 0-6000 ft. lbs.)

Every manufacturer, design and production man should have this valuable data. Sent upon request.

STURTEVANT TORQUE MANUAL

PA **STURTEVANT CO.**
ADDISON QUALITY ILLINOIS

The flexibility of **Waveflex** Waveguides

may be the perfect answer to your microwave transmission problems in:

- RADAR
- FM
- TELEVISION

Designers of microwave transmission equipment are now taking full advantage of the flexibility of WAVEFLEX flexible waveguides without sacrificing any of the advantages of rigid waveguides. As a result, design problems are greatly simplified. WAVEFLEX waveguides offer lower attenuation loss, excellent impedance match, and extreme flexibility without loss of efficiency.

Standard WAVEFLEX flexible wave-

guides are made in accordance with joint Army-Navy specifications. We will gladly work with you in developing special Waveguides to serve in special applications.

Literature on request

Titeflex Inc., 410 Frelinghuysen Ave., Newark 5, N. J.

A
Titeflex
Product

IS YOUR RECTIFICATION PROBLEM LISTED HERE?

GPA 28100

- Battery Charging
- Battery Elimination
- Business Machines
- Carbon Arc Lamps
- Dynamotors
- Electroplating
- Elevator
- Exciter Lamps
- General Laboratory Use
- Generator Fields
- Magnetic Brakes, Chucks and Separators
- Motors
- Relays
- Telephone
- Solenoids

Whatever your particular application of D.C. may be, it need not be a problem. The OPAD-GREEN COMPANY is prepared to offer assistance in designing and constructing Selenium Rectifier power supplies and equipment for your specific needs. There is no obligation for this service. Write today for our Rectifier Questionnaire—proposals and recommendations will be forwarded promptly.

OPAD-GREEN COMPANY

71-2 WARREN ST., NEW YORK 7, N. Y. PHONE: BEekman 3-7385-6

SAVE TIME

cut costs

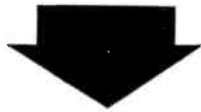

PRINT YOUR CIRCUITS WITH DU PONT CONDUCTIVE COATINGS

HERE ARE SOME TYPICAL USES OF DU PONT CONDUCTIVE COATINGS

FOR PRINTED CIRCUITS IN:

Television receivers
Radar equipment
Aircraft communication equipment
Audio frequency amplifiers
Hearing aids
Switchboards and panels
Industrial electronic controls
Recording equipment
Radios
Meters

ALSO FOR USE IN high- and low-voltage ceramic and mica capacitors (on TV receivers), static shieldings, resistors, and solder seals (for hermetically sealed coils, transformers, etc.)

Use them in place of conventional wiring and solder connections. These highly conductive, low-resistance coatings are easily and rapidly applied by spray, brush, dip or stencil to metals and non-conductive surfaces.

Look at these advantages:

1. High conductivity (low resistance).
2. Flexible application — composition may be formulated in suitable vehicles for desired methods.
3. Fired-on types unaffected by contaminating atmospheres.
4. Foolproof connections.
5. Easy application with simple, economical equipment.
6. High-speed production.
7. Economy — one troy ounce covers about three sq. ft.

Two types of Du Pont Conductive Coatings are available:

Type "F," fired-on, specifically designed for use on ceramic bases.

Type "A," air-dried, for use on plastic, paper, and wood bases.

For additional information
call our nearest office of Electrochemicals Department,
E. I. du Pont de Nemours & Co. (Inc.)

DISTRICT OFFICES

Baltimore 2	321 Fallsway	Plaza 2862	Kansas City 1*	Guinotte & Mich. Aves.	Victor 6240
Boston 10	140 Federal Street	HAncock 6-1714	Los Angeles	P. O. Box 70, El Monte, Calif.	CUMberland 3-2761
Charlotte 2, N. C.	427 W. 4th Street	CHarlotte 5-5561	New York 1	350 Fifth Avenue	LONgacre 3-6440
Chicago 3	7 S. Dearborn Street	ANdover 3-7000	Philadelphia 3	1616 Walnut Street	KINGSley 5-1900
Cincinnati 2	2412 Carew Tower	PARKway 5253	Pittsburgh 22	517 Park Bldg.	GRant 1-2960
Cleveland 14	1226 National City Bank Bldg.	CHerry 1-607B	San Francisco 6	111 Sutter Street	EXbrook 2-6230
Detroit 26	966 Penobscot Bldg.	WOODward 2-7360			

*Barada & Page, Inc.

Clip coupon for
your free bulletin
on Du Pont
Conductive Coatings

E. I. du Pont de Nemours & Co. (Inc.)
Electrochemicals Dept., Wilmington 98, Del.
Please send me Conductive Coatings
Bulletin CP 2-150

Name _____
Address _____
City _____ State _____



BETTER THINGS FOR BETTER LIVING . . . THROUGH CHEMISTRY

mercial types of vacuum-tube volt-meters available on the market today. Complete circuit diagrams are given, along with tabulated comparative data for guiding the prospective buyer. All types are included, from inexpensive kits to the most elaborate instruments. A bibliography of over 200 listings aids further investigation of particular instruments or topics.

It is difficult to think of a single aspect of this particular instrument that has been neglected. The industry is fortunate in having a book available that can acquaint its engineers so thoroughly with one of their most valuable tools. Such an understanding in any field is an asset.—J.F.

Transformers

By F. C. CONNELLY. *Pitman Publishing Corp., New York, 1950, 490 pages, \$7.50.*

IN RESEARCH work involving electrical and electronic circuitry, the need often arises for transformers having special characteristics. Quite often the circuit specialist finds himself stymied by the nonexistence of an appropriate transformer for his needs. In some of the more elaborate setups, special shops and trained personnel are provided for such cases. More often, the engineer himself must re-wind or start from scratch and prepare his own.

This British-authored book is designed as a guide in such cases. Carefully read, it can furnish the general engineer with transformer know-how and allow him to proceed logically and methodically in designing a special transformer for a specific application. Well-planned step-by-step procedures are suggested.

Basic principles are supplemented by separate sections on even the most advanced details of transformer work. Included are separate sections on multi-phase, power, high-voltage, vibrator, instrument, audio and output transformers, as well as autotransformers. A short section in the back of the book is devoted to special television types. Among the theoretic-

ENGINEERS DESIGNERS PHYSICISTS

THE Aerophysics & Atomic Energy Research Division of North American Aviation, Inc. offers unparalleled opportunities in Research, Development, Design and Test work in the fields of Long Range Guided Missiles, Automatic Flight and Fire Control Equipment and Atomic Energy. Well-qualified engineers, designers and physicists urgently needed for all phases of work in

- Supersonic Aerodynamics,
- Preliminary Design & Analysis,
- Electronics,
- Electro-Mechanical Devices,
- Instrumentation,
- Flight Test,
- Navigation Equipment,
- Controls,
- Servos,
- Rocket Motors,
- Propulsion Systems,
- Thermodynamics,
- Airframe Design,
- Stress & Structures.

- Salaries Commensurate with training & experience.
- Excellent working conditions.
- Finest facilities and equipment.
- Outstanding opportunities for advancement.

Write now — Give complete resume of education, background and experience

PERSONNEL DEPT.
AEROPHYSICS & ATOMIC ENERGY
RESEARCH DIVISION
NORTH AMERICAN AVIATION
INC.
12214 LAKEWOOD BLVD.
DOWNEY, CALIFORNIA

S.S. White MOLDED RESISTORS

The All-Weather Resistors

ARE USED IN HIGH VOLTAGE
"HIPOT" COUPLERS

S.S. White resistors are connected in series to permit a current flow to ground, when the "Hipot" Coupler is used to measure or to synchronize voltage of high voltage lines.

Canadian Line Materials, Ltd.—maker of "Hipot" Couplers and other transmission, distribution and lighting equipment says—"We have always found S.S. White resistors of the highest quality". This checks with the experience of the many other producers of electrical and electronic equipment who use S.S. White resistors.

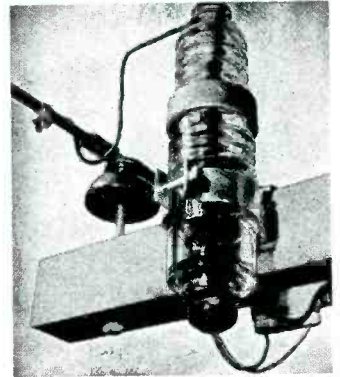

WRITE FOR BULLETIN 4906

It gives details of S.S. White Resistors including construction, characteristics, dimensions, etc. Copy with price list on request.



S.S. WHITE RESISTORS are of particular interest to all who need resistors with low noise level and good stability in all climates.

HIGH VALUE RANGE
10 to 10,000,000 Megohms
STANDARD RANGE
1000 Ohms to 9 Megohms

THE S.S. White INDUSTRIAL DIVISION
DENTAL MFG. CO.

Dept. R, 10 East 40th St.
NEW YORK 16, N. Y.

WESTERN DISTRICT OFFICE: Times Bldg., Long Beach, Calif.

TOUGH...

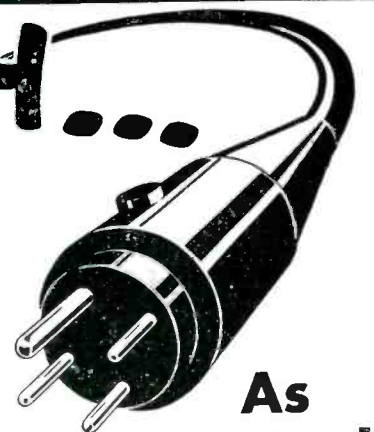
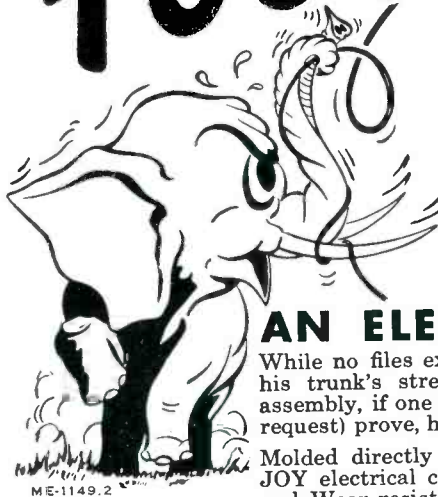

As AN ELEPHANT'S TRUNK!

While no files exist that prove an elephant ever tested his trunk's strength against a JOY Cable Connector assembly, if one ever does . . . other records (details on request) prove, he'll be tackling a tough job.

Molded directly to cable as one-piece Neoprene units JOY electrical connectors are Jerk-proof, Shatter-proof and Wear-resistant—Special construction and resilient rubber mounting of pins and spring loaded sockets insure a long life of low contact resistance — and the famous JOY Water-Seal automatically protects connections from dirt, oil or water.

A wide variety of sizes, shapes and pin combinations are available to meet the portable power requirements of TV, FM, AM or PA Circuits. No. 4A093 Male plug illus.

100 Years of Engineering Leadership

JOY MANUFACTURING COMPANY

HENRY W. OLIVER BUILDING, PITTSBURGH 22, PENNSYLVANIA
IN CANADA: JOY MANUFACTURING COMPANY (CANADA) LTD., GALT, ONTARIO

Consult a
Joy Engineer



cal discussions are chapters on magnetic leakage, core excitation, transients, losses, efficiency and regulation.

The introductory material is quite easy to understand. The analogies between the electrical circuit and the magnetic circuit are clearly emphasized and helpful in creating an understanding of the latter. The book is highly recommended for the beginner or the expert.—J.F.

Semi-Conductors

By D. A. WRIGHT. *Methuen's Monographs, John Wiley & Sons, Inc., New York, 1951, 130 pages, \$1.75.*

THIS condensed, elementary treatment of basic semi-conductor theory should be of considerable value as a means of review for the physicist or as an introduction to the subject for the student. Engineers could particularly benefit because its logical sequence of presentation of concepts would give them a basic understanding of the subject and permit more intelligent use of the more rigorous and fundamental texts.—J. P. JORDAN, *Electronics Laboratory, General Electric Co., Syracuse, N. Y.*

Receiver Circuitry and Operation

By A. A. GHIRARDI AND J. R. JOHNSON. *Rinehart Books, Inc., New York, 1951, 669 pages, \$6.00.*

HERE is basic coverage of the circuits most often encountered in modern television, a-m radio and f-m radio receivers, written for the technician and student who seeks to bring his education up to date. The treatment is nonmathematical and has a minimum of complicated theoretical analysis of circuit operation. Even the number of graphs is held to an absolute minimum. A knowledge of radio and electrical fundamentals, including vacuum-tube theory, is assumed to have been obtained elsewhere; practical servicing and troubleshooting procedures are likewise absent but are scheduled for a second volume now in preparation. Chapters dealing with construction and operation features of components and acces-



increased harmonic resolution

WITH PANORAMIC sonic analyzer LP-1

Specifically designed for applications demanding maximum resolution, the LP-1 offers many new possibilities in high speed audio waveform analysis.

20 KC log scale provides a complete visual spectrograph of the sonic spectrum from 40 to 20,000 cps. A tuning control and a three-step scanning range selector permit selection and magnification of any spectrum segment for sharp, detailed analysis.

Write now for complete details.

4 Selectable Scanning Ranges Pre-adjusted Optimum Resolution

Scanning Range	Resolution
100 cps	26 cps
500 cps	53 cps
1500 cps	105 cps

SPECIAL APPLICATIONS

- Investigations of closely spaced sound and vibration frequencies
- Harmonic analysis of wave forms having low frequency fundamentals
- Spectrum analysis requiring constant band width

10 SOUTH SECOND AVE., MOUNT VERNON, N. Y.



Kahle

specialists in custom-built, ultra-precision

ELECTRON TUBE MACHINERY

KAHLE CUSTOM-BUILDS machines to make the exact tubes you require—from big 20-inchers to tiny sub-miniature—from laboratory types to those for high-speed production. Kahle puts each unit through exhaustive trial runs in our plant to assure trouble-free operation in yours.

#1463 48-POSITION EXHAUST MACHINE

All degrees of operation from manual to completely automatic. Production limited only by pump equipment or loading speed of operator.

Consultations invited
Send for our new catalog

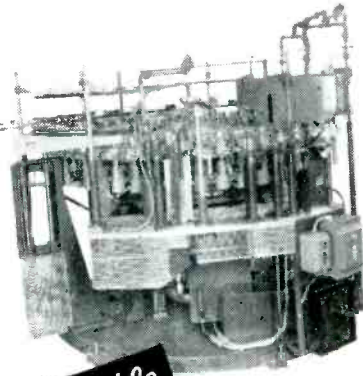

Production-boosting, labor-saving equipment for complete manufacture of cathode ray tubes, standard, miniature and sub-miniature radio tubes, sub-miniature tubes, fluorescent lamps, photocells, x-ray tubes, glass products.

Kahle ENGINEERING CO.

1309 Seventh Street, North Bergen, New Jersey

Select a tough job

for a

BRAIDED LACED OR TAPED HARNESSES

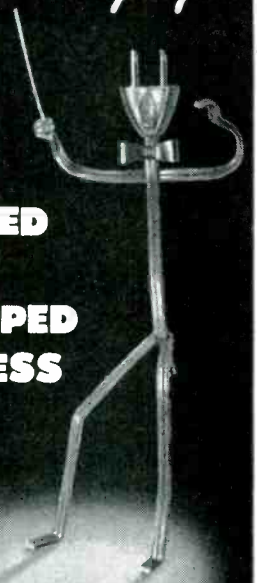

Then select a PHALO HARNESS

PHALO harnesses thrive on the tough tests! That's because they're made to carry their share of the current load, without strain, whatever that load is!

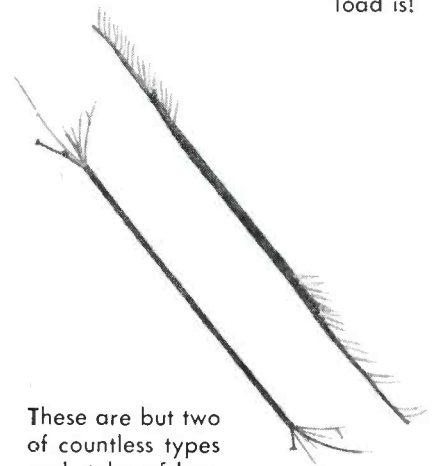

These are but two of countless types and styles of harnesses made by PHALO. Ask for the latest PHALO catalog giving full details on all PHALO HARNESSES.

PHALO

Plastics Corporation

Manufacturers of Thermoplastic Insulated Wire, Cables, Cord Sets and Tubing to Government Specifications.

CORNER OF COMMERCIAL STREET

after you've read
this magazine

... and clipped pertinent ideas, articles and advertisements for reference, please do not burn or throw it away.

Here are two sound reasons why:

- 1) Wastepaper can help to swell the funds of your local Boy Scout Troop, your church or other community organization. It gets a good price these days.
- 2) Whether in magazine form or not, wastepaper helps to fill the increasing need for paper pulp brought on by the mobilization effort.

Collect it. Give it to your favorite organization. Chances are they have scheduled pick-ups.

WHEN YOU THINK OF
**VERY
LOW
FREQUENCY**
THINK OF

SIE

- OSCILLATORS
1/100 CPS — 120,000 CPS
- TRANSFORMERS
Miniature Hermetically Sealed
- AMPLIFIERS
- DC AMPLIFIERS
- CARRIER AMPLIFIERS
- AC-DC VOLTMETERS
- RESISTANCE METERS

Write for Descriptive Bulletins

SOUTHWESTERN INDUSTRIAL ELECTRONICS COMPANY

2831 Post Oak Road Houston, Texas

and CABLE

In almost endless variety of sizes, insulation and colors to your specifications, Runzel products are available to assist you in your wiring problems.

Shielded wire and cords . . . popular hook-up and lead-in wire . . . speaker cords and all types of insulated wire products.

Precision made RUNZEL products are the finest. Write for samples.



RUNZEL

CORD & WIRE CO.
4723 Montrose Avenue
Chicago 41, Illinois

RECTIFIERS

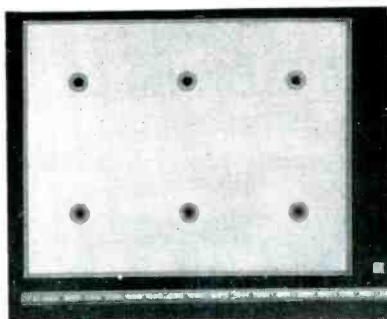

1" sq. to 12" x 16" cells—in stacks, or single cells for customer assembly.

Made by a new process to a uniform, high quality for continuous, heavy-duty service.

Write for literature

SYNTRON CO.

241 Lexington Homer City, Pa.

BASE, RARE AND PRECIOUS
METALS AND ALLOYS

SMALL UNITS

SMALL SIZES

CLOSE TOLERANCES

Nickel alloy, filament wire and ribbon: flat, grooved, crowned.

Grid wire electroplated.

Alloys for special requirements, bare or enamelled.

Further details upon request.

SECON

METALS CORPORATION
228 East 45th Street, New York 17, N. Y.
MUrray Hill 7-1594

The NEW DeJUR

30 YEARS OF PRECISION

ELECTRICAL EXPERIENCE is the heritage behind all DeJUR products engineered and manufactured to meet rigid government requirements. Actual performance records prove that DeJUR components stand up under adverse conditions of vibration, tropical heat and moisture. There's a type to fill your individual need. We can and do produce these units to your design. Your specifications are invited and our engineers will be glad to assist you.

PRECISION Potentiometers

SERIES L-400 and L-140

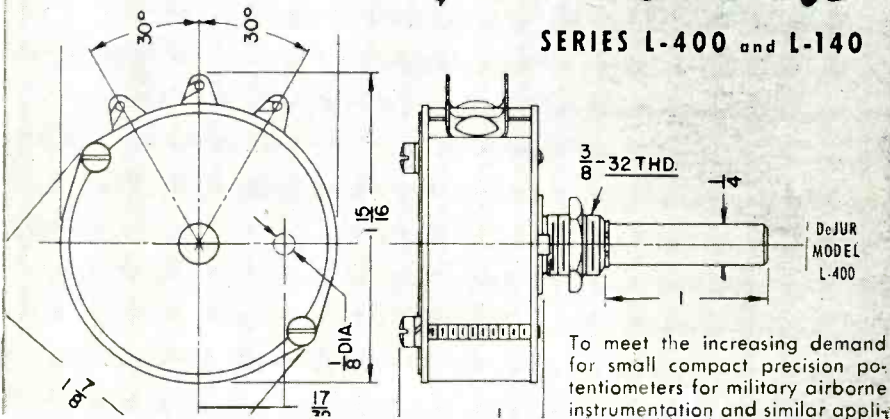

To meet the increasing demand for small compact precision potentiometers for military airborne instrumentation and similar appli-

NEW BOOKS

(continued)

sories include: Loudspeakers; Receiving Antenna Systems; Home Recorders; Phono Pickups and Record Players; Automatic Record Changers; Mechanical Construction of Receivers.

Explanations in this book are clear and concise throughout, and questions at the ends of chapters provide a thorough test of mastery of the contents. Equally deserving of commendation are the excellent drawings, which show that the artist understood what he was doing. Long waited for, the book goes far toward filling the demand for up-to-date information in a style comparable to Ghirardi's still-selling 1931 edition of *Radio Physics Course* and his almost equally out-of-date *Modern Radio Servicing*.—J.M.

Advances in Electronics

Try Remler for Service-Tested "Hard-to-Get" Components

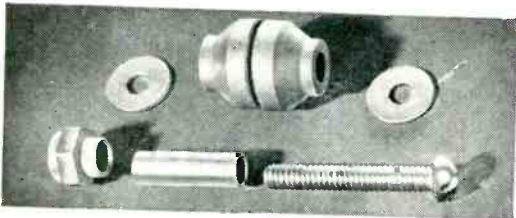

SILASTIC RUBBER SHOCK MOUNTS

① Ideal for sub-panel mounting. Isolates tubes from shock and vibration. Mount retains compliance from *minus* 70° to *plus* 480°F. Invaluable for military and airborne equipment.

Custom Components

Metal-plastic components designed and manufactured to order. Write for quotations specifying electrical and mechanical characteristics. Describe application. No obligation.



MINIATURE TUBE CLAMP

② Corrosion resistant. Holds miniatures in sockets under severe conditions of shock and vibration without restricting air circulation. Easy to insert and withdraw tubes. Three sizes.

Remler Company Ltd.
2101 Bryant St. San Francisco 10, Calif.

Remler

Since 1918 PIONEERS IN ELECTRONICS AND PLASTICS

DANO COILS STAR IN ANY LEAGUE



Whether you need a simple coil winding or specially treated coils deeply impregnated with wax or varnish in vacuum impregnation tanks and cured in heat controlled ovens—get on the winning team with DANO COILS.

- Form Wound
- Paper Section
- Acetate Bobbin
- Bakelite Bobbin
- Cotton Interweave
- Coils for High Temperature Applications

ALSO, TRANSFORMERS MADE TO ORDER



THE DANO ELECTRIC CO.
MAIN ST., WINSTED, CONN.

WASHERS—ALL KINDS



WASHER SPECIALISTS for nearly half-a-century. Dies in stock will produce most sizes. Big runs made with automatic presses. An economical, accurate, and highly reliable source for washers, also all kinds of metal stampings. HAVE WHITEHEAD'S CATALOG ON FILE; write for it.

BEVELED CUP
D-HOLE RETAINER
LOCK
SPACERS
SPRING TENSION
SQUARE HOLE
STAR LOCK
THRUST TONGUE



WHITEHEAD STAMPING COMPANY

1691 W. LAFAYETTE

DETROIT 16, MICH.

NEW BOOKS

(continued)

vide a clear picture of absorption phenomena, and an analysis of theoretical and practical resolution capabilities is presented.

The second chapter contains information compiled by R. R. Warnecke, P. R. Guenard, M. Chodorow, and E. L. Ginzton. The first two are affiliates of the Laboratoire de Recherches de la Compagnie Générale de T.S.F., Paris, France; the latter two are on the staff of Stanford University, Stanford, California. This chapter discusses velocity-modulated tubes, beginning with the basic concepts that led to the development of the klystron, and working into even the most detailed aspects of klystron operation in low-noise, low-power and power klystron amplifiers.

Electronic theory of the plane magnetron is discussed by L. Brillouin, of International Business Machines Corporation of New York, in the third chapter. Here again the discussion starts off with basic concepts and evolves into a detailed description from beginning to end in the field of plane magnetrons. Cylindrical magnetron history and theory are presented by L. Brillouin and F. Bloch of International Business Machines Corp. and Stanford University respectively. Through the engineer's medium of curves and equations, the subject is covered quite concisely.

John E. White, of the National Bureau of Standards at the time of writing but now with General Electric Co., Schenectady, describes tube miniaturization. Physical and electrical problems peculiar to the subminiature tube field are presented. The next chapter serves to supplement White's chapter by giving details on subminiaturization techniques. In this chapter Gustave Shapiro, of the National Bureau of Standards, presents a general picture of the methods and problems of constructing electronic equipment using subminiature tubes and components. Much of the subminiature information presented has been set down elsewhere, in various manufacturer's catalogs, but the organization of this summary is quite good, and the subject made interesting.

H. F. Mayer, of the School of



BRASS
STENCILS

STEEL STAMPS

Gov't. Regulation Stamps

MADE

TO

ORDER

- Free 48 pg. Catalog • Same Day Service
- Direct from Manufacturer
- Base-Lock Interchangeable Rubber Type

Order by Phone or Mail

U.S. RUBBER STAMP CO.

227 Fulton St., New York 7, N.Y.—CO. 7-5714

EISLER Television Tube MACHINERY

- ECONOMICAL
- MODERN DESIGN
- PRODUCTION ENHANCING

Machines for
Manufacturing
Incandescent
Lamps, Radio
and Electronic
Tubes

TV Sealing Machine

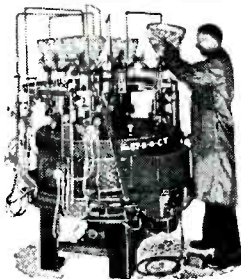

From 5" to huge 24"
Television Tube

RESISTANCE
WELDERS
1/2 to 300 KVA

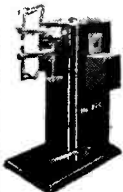

EISLER'S Electronic Equip-
ment is especially De-
signed and Built to your
exact requirements.

EISLER TRANSFORMERS
STANDARD • SPECIAL

WE INVITE YOUR INQUIRIES Sizes From 1/4 to 500 KVA



EISLER ENGINEERING CO., Inc.

751 So. 13th St. Newark 3, N. J.

GERTSCH

**MODEL FM-1 DIRECT READING
VHF FREQUENCY METER**

GENERATES OR MEASURES ANY FREQUENCY BETWEEN
20-480 MC, WITH A MINIMUM ACCURACY OF $\pm .005\%$

**DIRECT READING—NO CALIBRATION BOOK
FOR PORTABLE OR FIXED STATION USE**

For complete information or demonstration, contact the Fac-
tory or your nearest Engineering Representative listed below:



Albuquerque, New Mexico
Neely Enterprises
107 S. Washington St., Albuquerque 58731

Camden 2, New Jersey
Edward Braddock
726 Cooper Street, Woodlawn 3-3585

Chicago 40, Illinois
Alfred Crossley & Associates
4501 No. Ravenswood Ave., Uptown 81141

Dallas 5, Texas
Earl Lipscomb Associates
3561 Marquette Street, EMerson 1121

Detroit 6, Michigan
S. Sterling Company
1331 Linwood Ave., Townsend 83130

Fort Myers, Florida
Arthur H. Lynch & Associates
P. O. Box 466, Fort Myers 1269M

Houston 5, Texas
Earl Lipscomb Associates
2420-B Rice Blvd., Linden 9303

High Point, North Carolina
Bivens and Caldwell
Rm. 807, Sec. Bank Bldg., H. P. 3672

Los Angeles 46, California
Neely Enterprises
7422 Melrose Avenue, Whitney 1147

Sacramento 14, California
Neely Enterprises
309 Ochsner Bldg., Gilbert 3-7461

San Francisco 18, California
Neely Enterprises
2830 Geary Blvd., Walnut 1-3960

Washington, D. C.
E. R. Hitchcock
734 - 15th St., N.W., EXecutive 5635

EXPORT AGENTS

American Electroneering Corp., 5025-29 W. Jefferson Blvd., Los Angeles 16, Calif.

GERTSCH PRODUCTS

INC.

11846-48 MISSISSIPPI AVENUE—LOS ANGELES 25, CALIFORNIA
Mailing Address: P. O. Box 13856, W. Los Angeles 25, California

Here's Why it Pays You... to Read the Advertising

The advertising is a rich source of valuable information. In this magazine it offers you ideas and products that may well apply advantageously to your business.

Every issue is a catalog of goods, materials, and services—quickly available to you—just for the reading.

Leaders in business and industry turn to the advertising because they've discovered it helps them run their businesses more profitably.

When you read all the ads in this magazine, the chances are good that you'll get a lead that will materially help you do a better job. For example, you may find a specific piece of equipment that will be a profitable time-saver. Or a tool that will increase worker efficiency. That's why it pays to read the advertising. It's good business.

HEADQUARTERS FOR BUSINESS INFORMATION

McGRAW-HILL publications

F-23

THE WIDE BAND POCKETSCOPE

BY WATERMAN

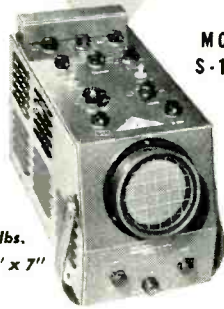

MODEL
S-14-B

Wt. 14 lbs.
12" x 6" x 7"

Another Waterman **POCKETSCOPE** confirming the obsolescence of conventional oscilloscopes. Characterized by wide band amplifier fidelity without peaking as well as amazing portability. S-14-B **POCKETSCOPE** is ideal for laboratory and field investigation of transient signals, aperiodic pulses, or recurrent electrical wave forms.

Vertical channel: 50mv rms/inch, with response within -2DB from DC to 700KC, and pulse rise of 0.35 μ s. Horizontal channel: 0.3v rms/inch with response within -2DB from DC to 200KC, and pulse rise of 1.8 μ s. Non-frequency discriminating attenuators and gain controls, with internal calibration of trace amplitude. Repetitive or trigger time base, with linearization, from 1/2cps to 50KC, with \pm sync. or trigger. Trace expansion. Filter graph screen. Mu metal shield. And a host of other features.

WATERMAN PRODUCTS CO., INC.

PHILADELPHIA 25, PA.
CABLE ADDRESS: POKETSCOPE

WATERMAN PRODUCTS INCLUDE:

5-10-B GENERAL	POCKETSCOPE
5-11-A INDUSTRIAL	POCKETSCOPE
5-14-A HI-GAIN	POCKETSCOPE
5-15-A TWIN TUBE	POCKETSCOPE
5-21-A LINEAR TIME BASE	

Also **RAKSCOPES, LINEAR AMPLIFIERS, RAYONIC® TUBES** and other equipment



NEW BOOKS

(continued)

Electrical Engineering, Cornell University, Ithaca, New York, writes on principles of pulse code modulation, with emphasis on noise, power and bandwidth. Next is presented a summary of modern methods of network synthesis by E. A. Guillemin of Massachusetts Institute of Technology. Theoretical and practical methods are covered, with typical examples furnished as illustrations.

The final chapter, prepared by Meyer Leifer and William F. Schreiber of the Sylvania Electric Products Inc., Bayside, New York, is an excellent discussion of communication theory. The authors have written from a standard outline on this subject, but their individual explanations are helpfully clear and easy to follow. They begin conventionally with summaries of the contributions of Hartley, Gabor, Tuller, Goldman and Shannon, and carry the theoretical analysis straight through to application in television and related fields. Here again sections of the analysis will be recognized as having been taken directly from the literature, but the organization increases their individual value many times.

The book is conveniently indexed, and a moderate number of pertinent references are included. The engineer who wishes to increase his knowledge beyond his particular project would do well to acquire a copy of *Advances in Electronics*, Volume Three.—J.D.F.

THUMBNAIL REVIEWS

THE ENGINEERING METHOD. By J. C. Fish. Stanford University Press, Stanford, Calif., 1950, 186 pages, \$3.00. Philosophy and practice of reaching engineering decisions as to which method, which equipment and which material to use in solving a particular problem. Comprises separate publication of chapters 9, 10 and 11 written by this author for "The Engineering Profession" (Hoover and Fish, Stanford University Press, 2nd edition, 1950).

MATHEMATICAL ENGINEERING ANALYSIS. By Rufus Oldenburger. The Macmillan Co., New York, 1950, 426 pages, \$6.00. Aimed at easing the transition from physical engineering situations to corresponding mathematics. Divided into five major parts, one of which is Electricity and Magnetism; this covers fundamentals, electric and electronic circuits and systems, tubes, transistors,

TRIAD Multiple and Single HEADERS

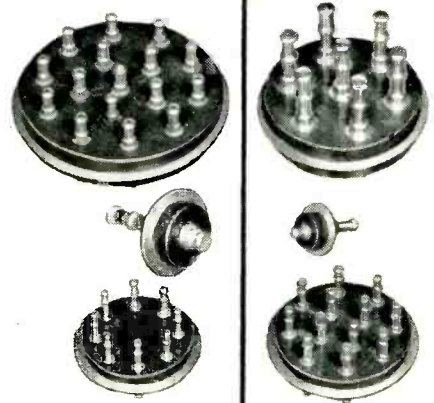

Suitable for MIL-T-27 Specifications

- Strong molded construction
- High conductivity
- Heavy current carrying capacity
- Turret type brass studs
- 3 to 16 terminals in a minimum of space
- Wide variety of patterns

Prices and specifications are contained in Bulletin TD-51, copies of which may be had on request.



2254 Sepulveda Blvd.
Los Angeles 64, Calif.

A new Family of High Speed

OIL DIFFUSION PUMPS



Pumps for every high vacuum operation; complete line of production and research.

HIGH VACUUM EVAPORATORS . . .

. . . and accessories. We can supply all types of vacuum coating (metal or non-metal).

OPTICAL FILM ENGINEERING CO.

2735 North Sixth St.
Philadelphia 33, Pa.

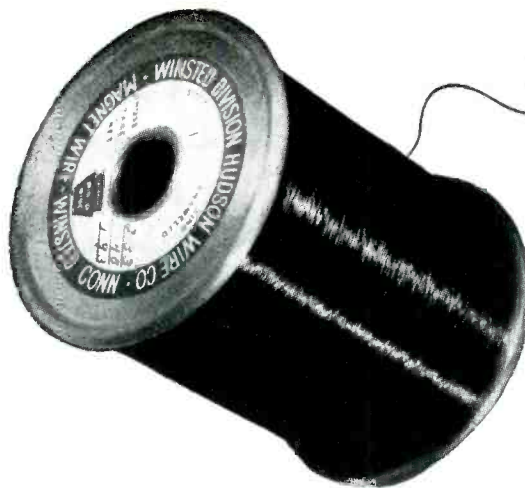

fine wire
made finer

Specify the electrical properties, flexibility, tensile strength, laying speed, uniformity and other characteristics you must have. Our Hudson and Winsted Divisions will meet and maintain your specifications.

Yes, "Fine Wire Made Finer!" That's why Hudson-Winsted fine wires are the first choice of electrical, radio-TV and electronic manufacturers whose products are noted for reliability and long life.

custom drawn
custom insulated
custom spooled . . .
to your most exacting requirements

Tell us your wire problems and requirements. Our research, engineering and production facilities are at your disposal. Let us quote!



hudson wire company

general offices: ossining, n. y. © winsted division, winsted, conn.

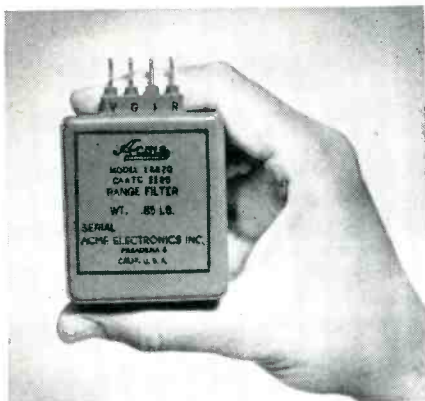

ACME RADIO RANGE FILTERS

On air lines all over the world, thousands of Acme's Radio Range Filters have given faithful service for years. Like most Acme designed filters, they are light, compact, hermetically sealed. They carry CAA type certificate No. 1120. Write for catalog sheet.

Acme
ELECTRONICS, INC.

300 No. Lake Ave., Pasadena 4, Calif.
Formerly Acme Metal Die, Inc.

Wave Filters • Delay Lines • Magnetic Amplifiers • Special Transformers & Chokes • Toroidal, Universal & Solenoid Wound Inductors

The New STAVER MINI-SHIELD

TRADE MARK REG. AND PAT. PEND.

The shield that fits all
Miniature
Tubes



A flexible shield that snugly fits all miniature tubes because it compensates for all variations in tube dimensions. Mini-Shields are made for both T5 1/2 and T6 1/2 bulb tubes. Send for catalog sheet.



91 PEARL ST. • BROOKLYN 1, N. Y.
ULSTER 5-6303

ELECTRONICALLY REGULATED LABORATORY POWER SUPPLIES

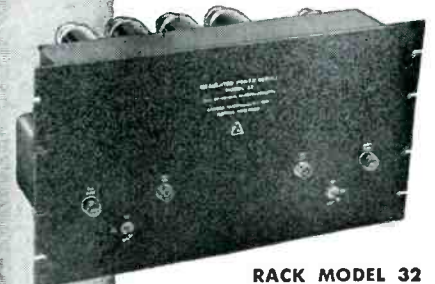

RACK MODEL 32

STABLE
DEPENDABLE
MODERATELY PRICED

- INPUT: 105 to 125 VAC, 50-60 cy
 - OUTPUT #1: 200 to 325 VDC at 300 ma regulated
 - OUTPUT #2: 6.3 Volts AC CT at 5A unregulated
 - OUTPUT #3: 6.3 Volts AC CT at 5A unregulated
 - RIPPLE OUTPUT: Less than 10 millivolts rms
- For complete information write for Bulletin E

STANDARD RACK MOUNTING PANEL SIZE 10 1/2" x 19" DEPTH 9" WEIGHT 38 LBS



LAMBDA ELECTRONICS
CORPORATION
CORONA NEW YORK

ANNOUNCEMENT!

MILO RADIO



TAKES PLEASURE IN ANNOUNCING ITS APPOINTMENT as DISTRIBUTOR for



WESTINGHOUSE INDUSTRIAL ELECTRONIC TUBES

COMPLETE STOCKS —IMMEDIATE DELIVERY!

• PLIOTRONS—High Vacuum Types MODULATORS • AMPLIFIERS • OSCILLATORS

Type Number	Filament Volts	Filament Amps	D.C. Volts	D.C. Ma.	Plate Diss. Watts	Output Watts	Class C
WL-473	6.9	60.00	5000	1400	2500	3900	
WL-807	6.3	0.90	600	100	25	40	
WL-813	10.0	5.00	2000	180	100	260	
WL-892	22.0	60.00	15000	2000	10000	20000	
WL-895	19.0	138.00	17000	9000	40000	100000	

—Partial Listing Only—

• THYRATRONS—Grid Controlled Rect.

Type Number	Filament Volts	Filament Amps	Peak Inverse Volts	Amps. Peak	Amps. Ave.
WL-414	5.0	20.0	2000	100.0	12.5
KU-627	2.5	5.0	5000	2.5	0.64
WL-672A	5.0	5.0	2500	40.0	3.2
WL-678	5.0	7.5	15000	6.0	1.6
WL-881	6.3	0.6	350	0.3	0.075

—Partial Listing Only—

• KENOTRONS—High Vacuum Rectifiers

Type Number	Filament Volts	Filament Amps	Peak Inverse Volts	Amps. Peak	Amps. Ave.
WL-456	11.0	20.0	140,000	0.50	0.06
WL-481	2.5	5.0	25,000	0.015	0.005
WL-579B	2.5	6.0	20,000	0.27	0.025
RO-585	5.0	1.1	1,500	0.011	0.003
WL-660	10.0	10.0	230,000	0.10	0.03

• PHANOTRONS—Gas or Mercury Vapor Rectifiers

Type Number	Filament Volts	Filament Amps	Peak Inverse Volts	Amps. Peak	Amps. Ave.
WL-575A	5.0	10.0	15000	6.0	1.5
WL-857B	5.0	30.0	22000	40.0	10.0
WL-866A	2.5	5.0	10000	1.0	0.25
WL-869B	5.0	18.0	20000	10.0	2.5
WL-872A	5.0	7.5	10000	5.0	1.25

• PHOTOTUBES—Light Sensitive Tubes

For starting, stopping, and controlling mechanical operations, i.e., counting, sorting, detecting smoke, opening doors, rejecting inaccurate materials, etc.

• IGNITRONS—Ignitor Controlled Rect.

Type Number	Volts Range	Max. KVA Demand and corresponding Ave. Current	Max. Ave. Current and corresponding KVA Demand
WL-681	200-600	300	12.1
WL-651	200-600	1200	75.6
WL-655	200-600	2400	192.0
WL-653B	2400	2400	135.0

• Voltage Regulators

Types OAZ/VR75 • OC3/VR105 • OD3/VR150

Send For Complete WESTINGHOUSE

Bulletin 86-020, illustrating and describing entire line of industrial electronic tubes.

MILO Also Features

Everything in Electronics

Parts and Equipment!

• Free 1053 Page Catalog!

Purchasing Agents! Write today on your company letterhead, stating official title, for our gigantic buying guide, filled with specifications and descriptions of all standard brand electronic items.



Write Dept. JE.
Write • Wire • Phone—or Teletype for Instant Action!

MILO RADIO & ELECTRONICS CORP.

200 GREENWICH STREET, NEW YORK 7, N. Y.
Phone BEekman 3-2980 • Teletype NY1-1839
Cable Address: MILOLECTRO

NEW BOOKS

(continued)

transducers; electromagnetic fields and procedures for setting up electrical problems.

F-M SIMPLIFIED. By Milton S. Kiver. D. Van Nostrand Co., New York, 1951, Second Edition, 458 pages, \$6.50. Completely revised to cover recent developments in both transmitters and receivers at an engineering level, with introductory chapters giving basic principles.

TELEVISION AND FM ANTENNA GUIDE. By E. M. Noll and M. Mandl. Macmillan Co., New York, 1951, 311 pages, \$5.50. Combination textbook and practical installation guide. First part gives principles of antenna systems, including wave propagation and transmission line theory. Second part, arranged as reference guide, covers antenna site surveys, choice of antenna, erection, installation of transmission line, use of boosters, characteristics of various antenna types, rotating antennas, multiple-outlet antenna systems, and interference reduction.

ALTERNATING-CURRENT ELECTRICAL SYSTEMS FOR AIRCRAFT. Westinghouse Electric Corp., P. O. Box 2099, Pittsburgh, 70 pages loose-leaf, \$1.50. Latest design requirements, maintenance hints, and data on various aspects of a-c power supply systems for large aircraft.

ADVANCES IN RADIOCHEMISTRY. By E. Broda. Cambridge Monograph on Physics, Cambridge University Press, New York, 1950, 152 pages, \$2.75. Production of radioelements, chemical properties, and aspects of transmutation relevant to nuclear synthesis. Final chapter covers new developments in technique of measuring radioactivity.

NUCLEAR SCIENCE ABSTRACTS, Cumulative Index to Vol. 1, 2, 3 and 4. U. S. Atomic Energy Commission, Technical Information Service, Oak Ridge, Tenn., 1951, 241 pages, \$.60. Cumulative author index, subject index, nuclide index, foreign geographic index, numerical index of AEC reports with indications of availability, list of AEC depository libraries and list of periodicals abstracted.

TELEVISION PROGRAMMING AND PRODUCTION. By Richard Hubbell. Rinehart & Co., New York, 1951, 240 pages, \$4.50. Second edition, revised and enlarged, with technical chapters brought up to date and with much new program material and many new illustrations.

UNDERSTANDING RADIO. By H. M. Watson, H. E. Welch and G. S. Eby. McGraw-Hill Book Co., New York, 1951, Second Edition, 716 pages, \$5.50. Revision of fundamental text for students with little or no background in electricity or science.

SOUND SLIDEFILM GUIDE. Operadio Mfg. Co., St. Charles, Illinois, 1951, 62 pages, \$1.00. Over 1,000 available sound slidefilms are listed, each with data on source, availability (free loan, rental rate or sale price), running time and nature of film. Includes 40 sound slidefilms giving technical training in electronics.

FOURIER TRANSFORMS. Ian N. Sneddon, University of Glasgow. International Series in Pure and Applied Mathematics, McGraw-Hill Book Co., New York, 1951, 542 pages, \$10.00. Theory of Fourier transforms and related topics, presented in a form suitable for students and research workers interested in boundary-value problems of physics and engineering. Seven of the ten chapters illustrate the use of the theory in solving problems of vibration, heat conduction, slowing of neutrons, hydrodynamics, atomic and nuclear physics, and elasticity.

new vacuum tube electrometer speeds component testing



The Keithley Model 200 Electrometer is a self-contained instrument ideally suited for incoming inspection, production testing, and servicing.

This dc voltmeter with a high input impedance quickly measures capacitor leakage (reads voltage decay caused by imperfect dielectric), dc voltage of charged capacitors, and leakage resistance or leakage current of insulators.

characteristics include—

- 2 and 20 volt ranges
- 10¹⁴ ohms, 6 mmf input grid drift current less than 5x10⁻¹⁴ amperes on the 2 volt range
- 5x10⁻¹³ amperes on the 20 volt range



For complete data write today for your free copy of our descriptive bulletin, "Vacuum Tube Electrometer, Model 200." Keithley Instruments, 1507 Warrensville Center Rd, Cleveland 21, Ohio.

Keithley Instruments

E-I HERMETIC SEALING COMPONENTS

NEW! OCTAL PLUG-IN WAFERS

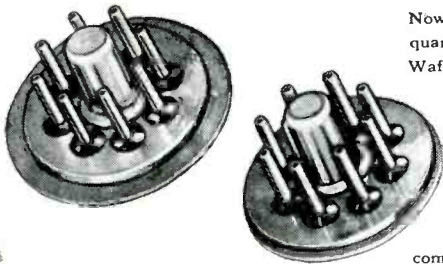

Now available in production quantities, E-I Series OBS Plug-in Wafers feature several important new developments. Hollow keys are form fitting and a new hermetic sealing technique makes the seal practically indestructible, even when the pins are bent. The entire assembly is extremely rigid. For complete data, call or write for the E-I illustrated brochure.

STANDARD SIZES	
MODEL	OUTSIDE DIA.
OBS 146	1.460
OBS 125	1.250
OBS 106	1.060



ELECTRICAL INDUSTRIES
INCORPORATED
44 SUMMER AVENUE • NEWARK 4, N. J.

Wizardry in WIRE FORMS

Small diameter wire formed in any shape you need!

IMMEDIATE CAPACITY FOR DEFENSE SUB-CONTRACTS

STRAIGHTENING & CUTTING
Perfect straight lengths to 12 ft.
.0015 to .125 diameter

WIRE FORMS
.0015 to .080 diameter

SMALL METAL STAMPINGS
.0025 to .035 thickness
.062 to 3 inches wide

★
Specializing in Production of Parts for Electronic and Cathode Ray Tubes

Write for Illustrated Folder
Send Blueprints or Samples for Estimate

ART WIRE & STAMPING CO.
227 High Street Newark 2, N. J.

FACTORY PRECISION

Instrument REPAIR and Standardizing



Prompt service whether your problem involves one or a hundred units. Our laboratory is fully equipped and technically staffed to handle the most complicated instruments and accessories.



Prompt Service

Certified Accuracy

PANEL METERS
VOLT-OHM METERS
Tube Checkers; Vacuum Tube Volt Meters and Laboratory Instruments

Standard Products Inc.
WHOLESALE DISTRIBUTORS
650 E. Gilbert, Wichita 11, Kansas
Inquiries Invited

No. 1 SOURCE

MILO RADIO

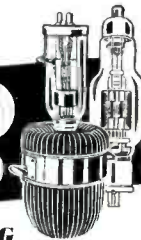

for ALL LEADING

INDUSTRIAL • ELECTRONIC & SPECIAL PURPOSE TUBES

Featuring
The NATION'S LARGEST STOCKS!
The NATION'S GREATEST NAMES!



Distributors for
WESTINGHOUSE
Quality Controlled
ELECTRONIC TUBES

- **PILOTRONS**—High Vacuum Type MODULATORS • AMPLIFIERS • OSCILLATORS
 - **THYRATRONS**—Grid Controlled Rectifiers
 - **IGNITRONS**—Ignitor Controlled Rectifiers
 - **KENOTRONS**—High Vacuum Rectifiers
 - **PHANOTRONS**—Gas or Mercury Vapor Rectifiers
 - **PHOTOTUBES**—Light Sensitivity Tubes
 - **VOLTAGE REGULATORS**
- Send For Technical Bulletin 86-020



DISTRIBUTORS for
SYLVANIA

GERMANIUM DIODES
STROBOTRONS
SILICON DIODES

- GAS PRESSURE MEASURING TUBES
 - ROCKET and TRIGGER TUBES
 - KLYSTRONS • GLOW MODULATORS
 - HYDROGEN THYRATRONS
 - TR and ATR TUBES • FLASH TUBES
- Send for Descriptive Bulletin EC-20E



DISTRIBUTORS for
GENERAL ELECTRIC

- INDUSTRIAL and XMITTING TUBES
 - IGNITRONS • KENOTRONS • PHANOTRONS
 - PHASITRONS • PHOTOTUBES • PILOTRONS
 - THYRATRONS • GLOW TUBES • BALLASTS
 - TR • ATR and PRE-TR TUBES
- Bulletin ETX-10E Available on Request



DISTRIBUTORS for
TUNG-SOL High Quality ELECTRON TUBES

VIBRATION TESTED
SPECIAL PURPOSE TUBES
Including Types 5687 and 5881
Write for technical literature.

Also
MINIATURE DIAL, RADIO, FLASH LAMPS
Write for Bulletin A-21-A

MILO HAS EVERYTHING!
Send for **FREE CATALOG!**
Purchasing Agents! Write today on company letterhead, stating official title, for your copy of our giant-size catalog, illustrating all major products in the radio-electronics industry—most of which we carry in stock! Write Dept. JE.



WRITE • WIRE • PHONE • TELETYPE for IMMEDIATE ACTION!

MILO-RADIO & ELECTRONICS CORP.
200 GREENWICH STREET, NEW YORK 7, N. Y.
Phone BEekman 3-2980 • Teletype NY1-1839
Cable Address: MILOELECTRO



TERMALINE DIRECT READING R. F. WATTMETERS

(DUAL RANGE)

MODEL 611—0-15 and 0-60 Watts

MODEL 612—0-20 and 0-80 Watts

IMPEDANCE—51½ Ohms

Models 611 and 612 are popular instruments in research and design laboratories, vacuum tube plants, transmitter manufacturing plants, and in fixed and mobile communication services.

They are ruggedly built for portable use, and are as simple to use as a D.C. voltmeter. The power absorbing load resistor is non-radiating, thus preventing transmission of unwanted signals which interfere with message traffic in communication services.

Frequency range: 30 to 500 MC (30 to 1,000 MC by special calibration)

Impedance: 51.5 OHMS—VSWR less than 1.1

Accuracy: Within 5% of full scale

Input connector: Female "N" which mates with UG-21 or UG-21B. Adapter UG-146/U is supplied to mate with VHF plug, PL259.

Special Scale Model "61s" are available as low as ½ watt full scale, and other models as high as 5 KW full scale.

Catalog Furnished on Request



BIRD ELECTRONIC CORP.
Termaline Coaxial Line Instruments
1800 East 38th Street • Cleveland 14, Ohio
West Coast Representative • NEELY ENTERPRISES • Hollywood 46, Calif.

MICRODIMENSIONAL WIRE

Custom-Enameled TO YOUR SPECIFICATIONS



The enamel-insulation of our microdimensional wire meets the high standards of quality set by all our products. The enamel is uniform, tough, flexible and has high dielectric strength. . . . Send us your specifications or inquire for further details.

SIGMUND COHN CORP. • 44 GOLD ST., NEW YORK 7



BACKTALK

(continued from page 152)

questions raised in the various symposia of the recent IRE convention in New York. It appears that a number of persons are interested in certain branches of medical electronics which are outside the scope of existing professional groups. However, the organization of such a group is quite a task at the best and it may be to our advantage to organize it within the IRE.

I have been assured that the IRE is interested and will do what it can to help. The task at hand now is to locate those persons who wish to become members of this group. The location of these people is complicated by the fact that they are scattered geographically, and in addition the papers they have published on medical-electronic subjects are scattered through all types of technical and medical publications. Therefore I am turning to **ELECTRONICS** to help locate them through this letter.

In other words, if any one is interested in becoming a member of the medical electronics group of the IRE, when organized, it would be appreciated if he would send me his name, address and state whether or not he is now a member of the IRE. Those interested will then be placed on the mailing list and notified as to the progress of the organization.

L. H. MONTGOMERY
*Dept. of Anatomy
Vanderbilt University
School of Medicine
Nashville 4, Tennessee*

Too Big

DEAR SIRs:

I HAVE JUST finished reading your editorial in May 1951 *Crosstalk* on the recent six-ring circus otherwise known as the IRE Convention and I want to take this opportunity to assure you that there are many others who agree with your sentiments. It was all too obvious to many that the attempt to funnel the large number of people present into six simultaneous sessions was disastrous, and that those who wished to pick up an early paper in one session and then transfer to another found themselves just as you mentioned—"out of luck." You may be sure that your final com-

ENGRAVING

ROUTING

PROFILING

MODELING

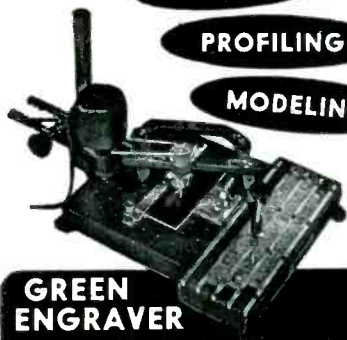

GREEN ENGRAVER

Proved Profitable —

Machine Tool, Radio, Electrical and Instrument Mfrs., Sales Promotion and Advertising.

Fast, rugged, convenient—and inexpensive. The Green Engraver is tops for low-cost performance—rips out precision work on metal, plastics or wood . . . cuts four lines of letters from 3/64" to 1" on curved or flat surfaces . . . operates by tracing . . . makes anyone an expert . . . engraves panels, name plates, scales, dials, molds, lenses and instruments. (Also widely used for routing, profiling and three dimensional modeling.) Electric etching attachment available.

Special attachments and engineering service available for production work.

FREE—Fact-packed folder. Send for yours, today

GREEN INSTRUMENT COMPANY



363 PUTNAM AVENUE
CAMBRIDGE, MASS.

FOR YOUR

STAINLESS STEEL FASTENERS...

IT'S **ALLMETAL**

for quality
and
delivery

ALLMETAL, Specialists in Stainless, Produce Stainless Products Exclusively



ALLMETAL
the leading source for Stainless Screws, Nuts, Bolts, Washers, Pins, Rivets. Made right, Priced right. "AN" and Standard Types carried in stock. Phillips Recessed Head Screws and Specials available too.

WRITE FOR CATALOG C



MANUFACTURERS SINCE 1929

ALLMETAL

SCREW PRODUCTS COMPANY, INC.

33 GREENE STREET NEW YORK 13, N. Y.



ATTENTION!

Former Field Engineers

We urgently need men with electronic background, and preferably radar experience, to supervise, instruct and assist in installation—maintenance of electronic equipment.

Excellent starting salary during factory training, plus overtime premium in field. Substantial insurance program. Overseas duty not mandatory. Salary commensurate with experience.

Please forward your personal experience record to:

Personnel Supervisor
Field Eng. Div.

Reeves Instrument Corp.
215 East 91st St.
New York, 28, N. Y.

Little thought-of facts about capacitors

The short time breakdown voltage of a well-made D.C. capacitor is not less than 5 to 6 times the actual working voltage at 20°—

$$E = 5 \times e \text{ min.}$$

E = Breakdown voltage
e = Rated d.c. working voltage

INDUSTRIAL CAPACITORS are unvaryingly held to this formula.

Designed for maximum safety and the smallest possible volume, INDUSTRIAL CAPACITORS are the most widely used capacitor in industrial applications.

WRITE TODAY FOR DETAILED CATALOG

INDUSTRIAL CONDENSER CORP.

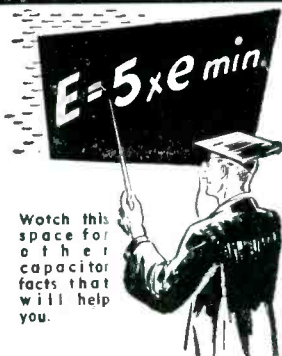

Sales Offices in
All Principal Cities
3243 N. California Ave.
Chicago 18, Illinois

An Accredited Technical Institute
Pioneer in Radio Engineering
Instruction Since 1927.....

CAPITOL RADIO ENGINEERING INSTITUTE

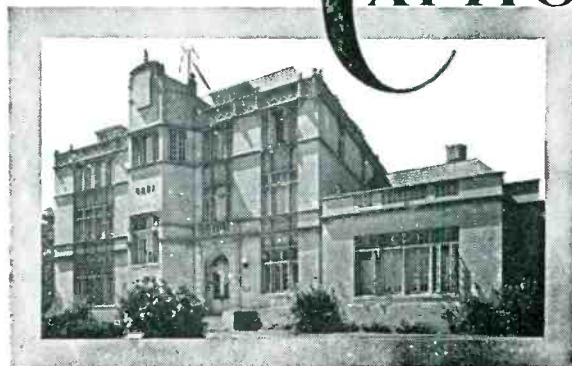

● Advanced Home Study and Residence Courses in Practical Radio-Electronics and Television Engineering.

Residence Courses approved for Veteran Training

● Request your free home study or residence school catalog by writing to Dept. 287C.

16th & Park Road, N.W., Washington 10, D. C.

MICROPOT

PRECISION TEN-TURN POTENTIOMETER

1. You get permanent accuracy because the resistance wire is locked in place. It is precision positioned and moulded integrally with the housing.
2. You get permanently accurate settings, smooth action and low uniform torque provided by the stainless steel, precision ground, double thread lead screw guiding the moving contact.
3. You get precise positioning of the moving contact because of the two bearings supporting the rotor assembly.
4. You get good rigid terminals because they are moulded integrally with the housing.
5. Terminals soldered to ends of resistance element before moulding. Entire resistance circuit is an integral part of the housing.
6. You get accurate setting and re-setting due to anti-backlash spring in contact guide.
7. You get a fine resolution because of the $4\frac{3}{4}$ " length of resistance wire in the spiral element.
8. You get a resistance output directly proportional to shaft rotation within $\pm 0.1\%$ of the total resistance. Every potentiometer is automatically machine tested for linearity at 101 points.

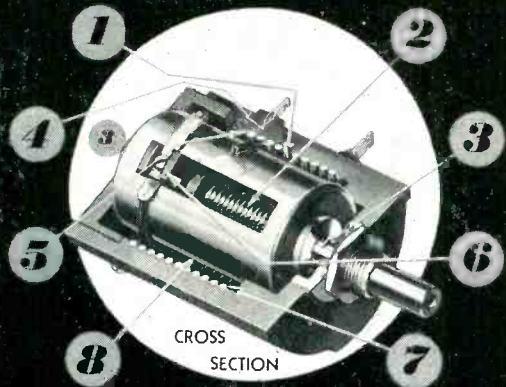

**LINEARITY
ACCURACY $\pm 0.1\%$**

Units for immediate shipment:
1,000 to 30,000 ohm range.
Special resistance values made to order.

WRITE TODAY FOR
ENGINEERING INFORMATION



BORG EQUIPMENT DIVISION
THE GEORGE W. BORG CORPORATION
DELANA • WISCONSIN

BACKTALK

(continued)

ment in regard to the use of "a sharp and heavy axe" has found a responsive chord in me.

I have heard numerous expressions to the effect that it would have been much better to have had a major reduction in the number of papers and a major improvement in their technical excellence.

Since this is the first time I have ever written to an editor of any magazine, I may as well comment further on the sound editorials which now appear over the signature of McGraw-Hill Publishing Co., Inc. The sound advice on economic questions offered so many times in the past would seem sufficient reason for placing the President and the members of our Congress on your mailing list.

ELLSWORTH D. COOK

General Engineering Laboratory
General Electric Co.
Schenectady, New York

And, It Works!

DEAR SIRS:

ALTHOUGH I do not subscribe to ELECTRONICS, I always try to read every issue. For quite some time I have been doing a lot of experimental work with neon relaxation oscillators for use in electronic organs and I won't hesitate one moment to say these simple little oscillators have almost driven me to the point of throwing everything into the junk box and quitting.

I have tried and tested all circuits that have appeared lately in other magazines, but all these articles and circuits dwell on theory as to what these circuits should do. But they never work out in practice. Every article and writer has had a different theory on the way the neon tubes are to be synchronized with the master oscillators. The main difficulty was, of course, with frequency stability.

Then along comes a swell article on "Gas-Diode Electronic Organ" by Robert M. Strassner in your January 1951 issue. After all the hard work up to now I decided to give the circuits shown in his article a try. What a surprise. For the first time in months I had something put together that really worked.

My research into the subject of

FOR
RECORDING

strains

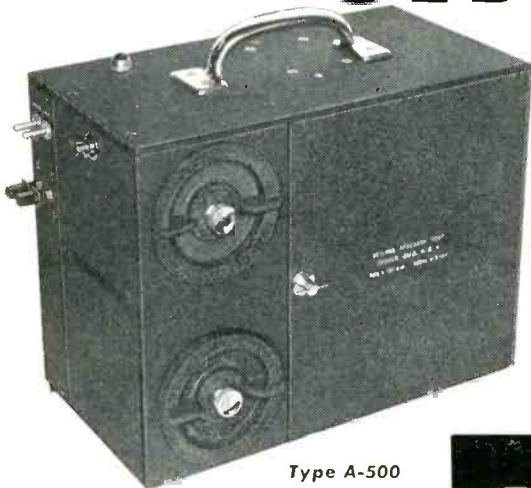

Type A-500
12-channel

Oscillograph Recorder

- The Heiland 500, because of the extremely small size and light weight, is widely used in aircraft and guided missile testing and by industrial and general research laboratories. The use of highly sensitive Heiland galvanometers permits the measurement of strains without the use of amplifiers.

For further information write

HEILAND RESEARCH CORPORATION 130 East Fifth Street
Denver, Colorado, USA

- Portable
- Compact (6 3/4" x 9 13/16" x 12 3/4")
- Light weight (33 lbs.)
- Easy loading
- 2 to 12 channels
- Many other features found only in much larger recorders

dependable instruments

Heiland
DENVER

CRITICAL
Instrumentation
RECORDING

to
100,000
cps!



Standard Models to 50,000 cps.
•
Custom-built Models to 100,000 cps.

AX-41

PRECISION PERFORMANCE

Unrivalled in audio spectrum recording . . . pioneers in critical instrumentation recording . . . 1 to 14 channel models.

AMPEX *Magnetic Tape*
RECORDERS

Amplex Electric Corp.
San Carlos, California

Standard of the Great Radio Shows

SPECIALTY



LAB-BILT DRY BATTERIES



INDUSTRY

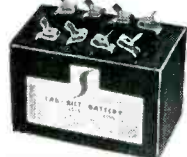

LABORATORY



RADIO AND IGNITION

Write for New
FREE CATALOG

Here are complete descriptions of 78 Lab-Bilt Batteries of industrial and hard-to-get types. Specification Sheet enables you to order batteries especially designed to your own requirements. No order is too small. Specialty makes and ships FRESH Lab-Bilt Batteries without delay. Get this new catalog today.

SPECIALTY BATTERY COMPANY

Ray-O-Vac

RAY-O-VAC

Subsidiary

MADISON 10, WISCONSIN

MICRODIAL

TEN TURN-COUNTING DIAL

Microdial is composed of two concentrically mounted dials . . . one for counting increments of each turn and the other for counting turns. The incremental dial has 100 equal divisions and is attached rigidly to the shaft so there is no backlash. Thus the contact position is indicated to an indexed accuracy of 1 part in 1000. Rotation is continuous in either direction. There are no stops on the Microdial assembly.

COMPACT . . . Microdial has same O.D. as Micropot . . . requires no more panel space.

CLEAR READING . . . Forced fast-reading tests showed only 1/20th as many errors with Microdial open window as with next most legible dial. Turn counter distinguishes between 0 and 10 turn readings, and accelerates to avoid confusion on readings near integral turns. Precise readings are made from larger dial with maximum separation of graduations and wide angle visibility.

CONVENIENT . . . delivered completely assembled with dials synchronized. Easily mounted in a few seconds. All dials may be locked.

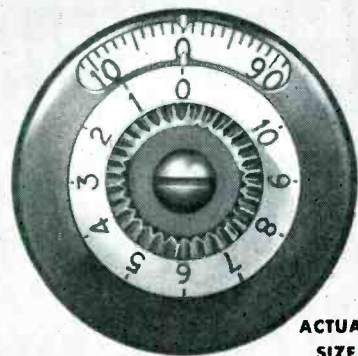

ACTUAL SIZE

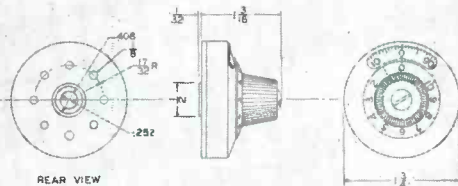

Microdial . . . turn-counting dial, primarily designed for use on Micropot ten turn linear potentiometers . . . use it on any multiturn device having ten turns or less.



BORG EQUIPMENT DIVISION
THE GEORGE W. BORG CORPORATION
DELANA • WISCONSIN

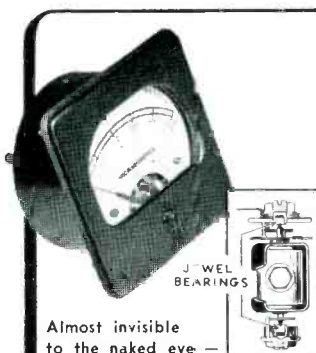

JEWEL BEARINGS

Almost invisible to the naked eye — yet precision depends on these quality controlled Bird Bearings

"Precision first!"

says famous instrument manufacturer . . . specifies Bird Jewel Bearings

Microampere Meters from this leading manufacturer* are world famous for top precision — owe much credit to quality construction that includes Bird Jewel Bearings. Two precision-made jewels — used as bearings for armature — assure smooth response . . . guarantee a lifetime of accurate operation.

Discover how Bird Jewel Bearings can solve your miniature bearing problems with unset or set assemblies to suit your requirements — write for information.

*Name on request

Richard H. Bird & Co., Inc.

1 Spruce Street, Waltham 54, Mass.

Mfrs. of glass and sapphire jewel bearings for instruments, dials and gauges of all types

CIRCUITS AND MICROWAVE ENGINEERS

Permanent Positions for Men with Several Years of Experience

A rapidly expanding organization with long range programs for commercial and government developments offers excellent opportunities in the field of general instrumentation including VHF, UHF, and microwave test equipment.

Our modern, well equipped laboratories are conveniently located in downtown Brooklyn and offer a stimulating and pleasant working atmosphere.

Men with Master's or Ph.D. degrees are preferred.



Polytechnic

RESEARCH and DEVELOPMENT CO • Inc.

202 TILLARY STREET, BROOKLYN 1, N. Y.

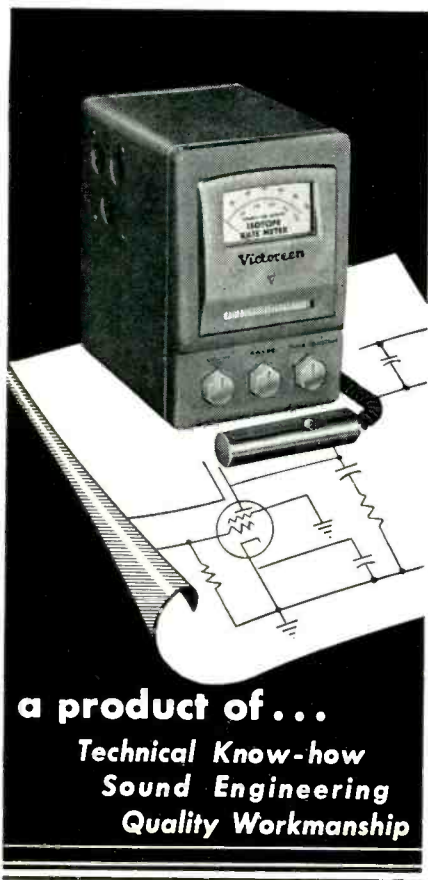

a product of . . .
Technical Know-how
Sound Engineering
Quality Workmanship

THE ISOTOPE RATEMETER

A New Laboratory Counting Ratemeter

The Model 524—Isotope Ratemeter is a laboratory-quality, counter-type ratemeter for detecting and monitoring alpha, beta, and gamma radiation. It has been designed for the exacting requirements of medical or laboratory personnel for use in chemical or isotope research laboratories. This instrument is applicable to civilian defense and numerous industrial requirements.

A wide selection of counting rates is provided: 0-300, 0-1000, 0-3000, 0-10,000, 0-30,000, and 0-100,000 counts per minute. Aural as well as visual presentation is featured. A three-position meter time-constant switch allows the operator to select the most desirable speed of response. The probe assembly uses standard co-axial base counter tubes and is connected to the case by means of a four-foot flexible cable. The instrument operates from a 115 volt AC supply. The rugged 10 x 7 x 8" case is finished in gray baked enamel.



For more complete information on the Isotope Ratemeter, write for Bulletin (Form 3002-B).

Victoreen
Instrument Co.

5806 HOUGH AVE.
 CLEVELAND 3, OHIO

electronic organs has covered all articles and every circuit I could lay my hands on, but Strassner's way of using an electrostatic coupling between the master oscillators and the neon relaxation oscillators in the octave divider chain is the best I've seen and tried.

As you must already know, this subject of electronic organs has become quite popular in the last year or so, and is given quite some space in other magazines; Richard Dorf, writing these articles, has been snowed under with letters asking for more information on the subject. These articles of his offer nothing concrete, but just enough to get the fellows started.

With what Strassner offered in his first article, why can't we have another by him and let him go a little deeper into the subject of master oscillators and the way the switches are mechanically linked to the playing keys. This subject demands another article giving a complete schematic and other constructional details.

Robert Strassner has kindled the spark in lots of fellows like myself, and now all we need is another good article to keep the fire going. I know that a swell magazine like ELECTRONICS won't let us readers down.

GLEN E. TURNER
 Fresno, California

Student Answers Briton

DEAR SIRs:

I SHOULD like to comment on the letter by C. H. Banthorpe published in the April, 1951 issue of ELECTRONICS. One might almost say I should like to take issue with him, for I feel that his statements are rather dogmatic on the basis of what has apparently been somewhat limited listening to vhf programs. There are no doubt many desirable features of a-m for vhf broadcasting, not the least of these being the use of the same detector for both the medium-frequency band and the vhf band during this changeover period when in most communities reception of both media is necessary to full program coverage. However, I should like to point out some considerations which

ONLY SPECIFIC COILS CAN DO THIS JOB-

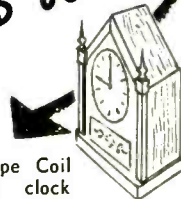

This Bobbin Type Coil is supplied to clock makers: Some use 37#, others may specify 38# or 40# wire; Deep wax or lacquer impregnation; enamel, formex, or nylon wire insulations. At Coto, it is usual to work to close tolerances.



COTO-COIL!
Builds Them!

When you need electrical coils, why not take advantage of 34 years of experience, engineering competence, and modern production facilities. Coto coils are built for you, to your specifications.

COTO-COIL

COMPANY

65 Pavilion Avenue
 Providence 3, R. I.



COIL SPECIALISTS SINCE 1917



Ungar's little Angels

DO A HEAVENLY SOLDERING JOB

Pick any job and you'll find a pip of a tip to use with the trim, slim Ungar Pencil. Any of the 8 Ungar Angels interchange in the No. 776 Handle to make a honey of a tool that does work faster and better than larger, heavier irons. Whatever your problem, you'll bless the day you discovered these saintly soldering cherubs!



No. 1239 3/4" HI-HEAT Chisel Tip, 37 1/2 Watts
Used and recommended for radio, radar and TV repair and maintenance, but because of greater tip temperature and more heat capacity, they are used on production lines for smaller work. Tip material is special pre-tinned alloy. Loss of tip material at high temperatures is less than with copper alloys
Write for Catalog No. 600

Ungar ELECTRIC TOOLS, INC., Los Angeles 54, Calif.

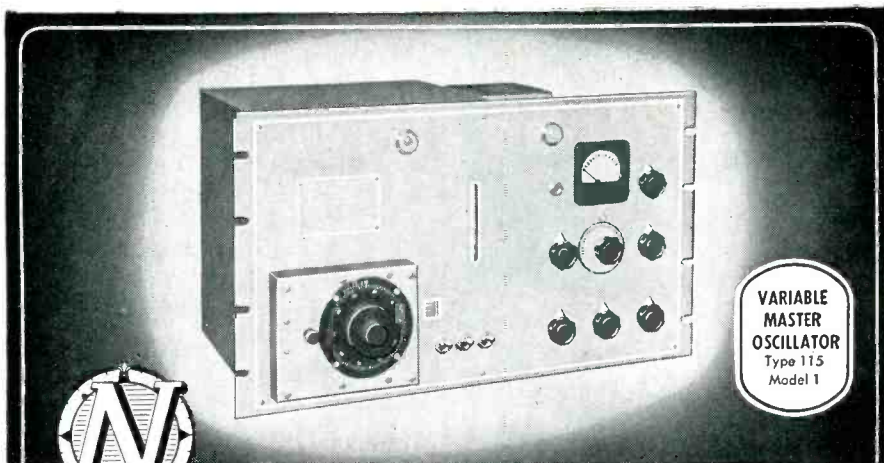

VARIABLE
MASTER
OSCILLATOR
Type 115
Model 1



The Variable Oscillator with CRYSTAL STABILITY

High versatility, plus wide range, plus crystal stability and accuracy—that's the unbeatable combination for the best in diversity reception. You get all three with the Northern Radio VARIABLE MASTER OSCILLATOR. The HFO's stability is ± 20 cps/mc for ambient change of $\pm 25^\circ\text{C}$.—matching that of any non-temperature controlled crystal. Its range is 2-32 mc continuous. Crystal check points, with 40 curves supplied, permit absolute frequency setting to ± 25 cps/mc. Three crystal-controlled frequencies provide fixed frequency reception. There's a LF crystal oscillator for BFO.

And, this unit also serves as an excellent transmitter exciter and laboratory measuring standard.

See the specifications on this outstanding model in the 1950 Electronics Buyers Guide. For complete data on the precision-built Northern Radio line, write today for your free latest Catalog E-7

NORTHERN RADIO COMPANY, inc. 143-145 West 22nd Street
New York 11, N. Y.

Pace-Setters in Quality Communication Equipment

PICKERING



SOLENOIDS For DC Circuits

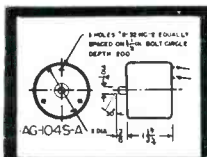

Pickering engineering service is available for special applications where Pickering standard Solenoids do not apply.

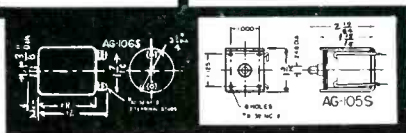

For details and literature address Department N
PICKERING & CO., INC.
Manufacturers of world-famous electro-magnetic phonograph cartridges and audio equipment.
Oceanside, L. I., New York

COMPOUNDS

Scientifically compounded for specific applications from waxes, resins, asphalts, pitches, oils, and minerals. Available in wide range of melting points and hardnesses. Special potting compounds are heat conducting and crack resistant at extremely low temperatures. Recommendations, specific data, and samples will be furnished on request.

for

IMPREGNATING
radio coils
transformer coils
ignition coils
wire coverings
paper tubes and forms
porous ceramics

DIPPING
Coils
Transformers
Condensers

SEALING
condensers
batteries
switch base terminals
socket terminals
light fixtures

POTTING
Radio Transformers
Light Units
Loading Coils
Condensers



BIWAX CORPORATION

3445 HOWARD STREET
SKOKIE, ILLINOIS

RECOGNIZED... FOR SERVICE TO THE INDUSTRY

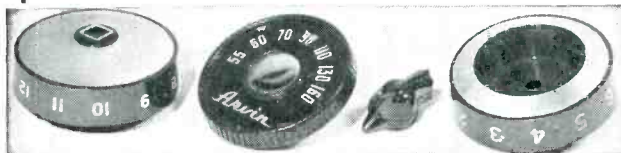

A Complete
Line of
Radio and
Television
KNOBS

Ceramic
Stand-off, Feed Thru,
and Tie Terminals
Army-Navy Approved

HORDEN
Designers - Engineers
MANUFACTURING CO.

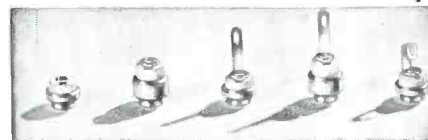

•KNOBS•PLASTIC EMBOSING•TERMINALS
4739 MONTROSE AVE. CHICAGO 41, ILL.

Important SAVINGS to VOLUME users of small parts

..like these

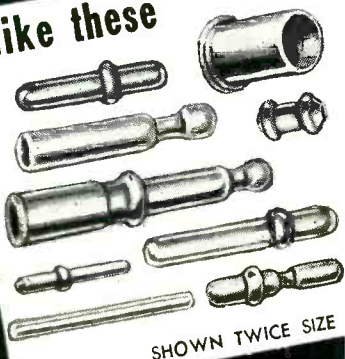

SHOWN TWICE SIZE

thanks to **MULTI-SWAGE**

If you need small tubular metal parts like these in large VOLUME, Bead Chain's MULTI-SWAGE Process can mean important savings to you.

Much Cheaper Than Solid Pins

Many prominent users of solid pins for electronic and mechanical purposes have cut costs by switching to Multi-Swaged tubular pins . . . without sacrificing strength or accuracy.

Typical Applications—

As terminals, contacts, bearing pins, stop pins, male-female connections, etc., in a wide variety of products such as Business Machines, Ventilator Louvres, Toys, Radio and Television Apparatus, Terminal-boards, Electric Shavers, Phonograph Pickups, etc.

Send part (up to 1/4" dia. and to 1 1/2" length) and your specs for a quotation or write for DATA BULLETIN.



THE BEAD CHAIN® MFG. CO.

88 Mountain Grove St., Bridgeport 5, Conn.

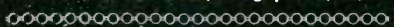

Manufacturers of BEAD CHAIN — the kinkless chain of a thousand uses; for pull and retaining chains and other industrial uses; plumbing, electrical, jewelry, fishing tackle and novelty products.

I believe favor f-m, at the same time inviting criticism of my views by any and all who are qualified.

Banthorpe makes the very good point that comparison of f-m on vhf with a-m on m-f is often misleading. This is quite true. But he then goes on to apparently commit this same misleading comparison in commenting on the relatively complex nature of the vhf f-m receiver compared to the m-f a-m receiver. I cannot see how the method of detection would materially influence the major problems of oscillator stability and low gain per stage. The first appears to be a consequence of the very high frequency at which the local oscillator must operate, and the second to be a consequence of the high intermediate frequency necessary to prevent the local oscillator locking in with the incoming signal. As a matter of fact, the gated beam tube recently developed in this country may make the f-m vhf set less complex than its a-m complement. This tube and very few associated components produces near zero time constant limiting, and is a discriminator that delivers sufficient output to permit doing away with the first audio tube. It also obviates the necessity for an automatic gain control circuit, saving several parts.

Automatic gain control deserves a bit more comment. Fades that reach the lower audio frequencies in their rates of occurrence are not uncommon on vhf. They are particularly noticeable in the presence of nearby aircraft, a problem far from negligible now, and one not likely to decrease. To design a circuit with time constants such that it can deal with these fades with anything approaching the effectiveness of the f-m limiter and which will yet not act to attenuate or distort the lowest modulation frequencies of the a-m signal sounds to me like quite a project, and one not likely to contribute to economy.

And that brings up attenuation of frequencies in the reproduced signal and distortion. In the a-m receiver, if flat response is to be achieved, along with good signal-to-noise ratio and adjacent-channel selectivity, the i-f curve must approach the ideal very closely. In

distributors
for 30 years
of radio and
electronic
components for
all your needs

**RADIO
WIRE
TELEVISION**
INCORPORATED

NEW YORK 13, N. Y.

100 Sixth Avenue
WALKER 5-8883

NEWARK 2, N. J.

24 Central Avenue
MArket 2-1661

BOSTON 10, MASS.

110 Federal Street
HUBbard 2-7850

Lafayette 100 SIXTH AVE.
DIV. RADIO WIRE TELEVISION, INC.
FOR CUSTOM RADIO AND TV COMPONENTS

Custom assemble your own high fidelity phono-radio-television ensemble. All famous name components at lowest prices. Send for Free hi-fi catalog to Dept. E.

the f-m set, minor departures from the ideal are cleaned up by the limiter. And since the i-f curve and tuning are so closely linked, it might be well here to point out that if the i-f response were made optimum for adjacent channel selectivity and noise level, the same amount of detuning that causes moderate distortion on f-m (this considered to be a weakness of f-m) would not only cause distortion, but might even tune right off the station completely.

Banthorpe has excited my curiosity about several new English developments. He notes that there is available a simple diode noise limiter of value for broadcast work. This is obviously a considerable improvement over the latest type of noise limiter I have seen for a-m receivers, for this type is capable of limiting noise only to the level of the maximum modulation of the received signal. Since the noise level for good reception of entertainment should be somewhat lower than this, I had always supposed the device to be virtually useless for broadcast reception, even discounting the extremely critical adjustment of the threshold control.

He has also whetted my interest in the BBC tests. I am a little chagrined that the only comment on the method of modulation used in the BBC f-m transmitter is that it is a "simplified design". (This is not Banthorpe's statement, but comes from another publication and is the most description I have so far been fortunate enough to find.) Despite my great faith in the high engineering standards of the BBC, this reticence to comment tends to disturb me. It also appears that Banthorpe has been willing to draw conclusions somewhat before the BBC itself was willing to do so.

Now as to the use of f-m sound with television, in addition to the foregoing we may sight the ease of separation of sight and sound intelligence when different modulation systems are employed for the video and audio portions of the signal. Indeed, the intercarrier technique of beating the sound against the picture carrier to obtain the 4.5 i-f would doubtless be impossible with a-m, and this is one of the

Engrave

... PANELS UP TO 25" WIDE
IN YOUR OWN SHOP WITH THE
NEW ENGRAVOGRAPH

Portable Model 1-S

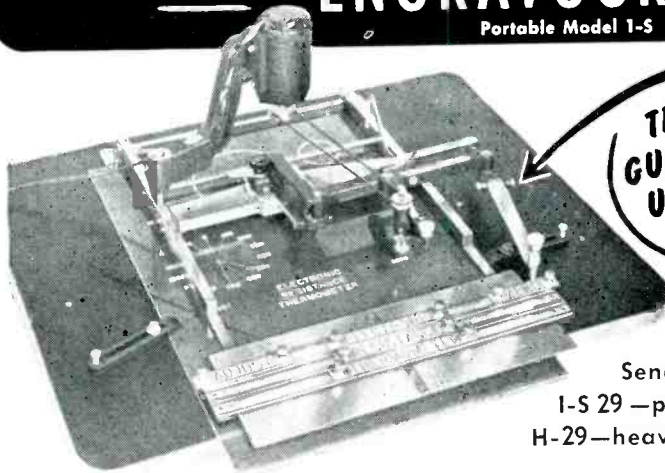

TRACER
GUIDED FOR
UNSKILLED
LABOR

Send for Booklets
I-S 29—portable model
H-29—heavy duty model

NEW HERMES, Inc. • 13-19 University Place, New York 3, N. Y.
CANADA: 359 St. James St., Montreal

new hermes

Engravo-graph

- The only portable machine which reproduces 15 sizes from one master alphabet.
- The only one with adjustable copy holding slides for multiline engraving in one set-up.
- Self-centering holding vise for nameplates and dials.

NEW HERMES, Inc. • 13-19 University Place, New York 3, N. Y.
World's Largest Manufacturer of Portable Engraving Machines

HOBSON PRECISION COMPONENTS

HIGH VOLTAGE GRID CAPS
Fit both .250 in. & .360 in. high voltage tube grids

ELECTROSTATIC PICTURE TUBE CONNECTOR

ELECTROLYTIC MOUNTING PLATES Fit 1 in. & 1 3/8 in. condenser cans

HOBSON BROS. • 4049 W. Fullerton St. • CHICAGO 39, ILL.



VIBRATORS!
By every test

ATR

is Best!

ATR
AUTO RADIO
VIBRATORS

have Ceramic Stack Spacers



Free

A COMPLETE LINE OF VIBRATORS . . .
Designed for Use in Standard Vibrator-Operated Auto
Radio Receivers. Built with Precision Construction, fea-
turing Ceramic Stack Spacers for Longer Lasting Life.
Backed by more than 19 years of experience in
Vibrator Design, Development, and Manufacturing.

ATR PIONEERED IN THE
VIBRATOR FIELD.

NEW MODELS NEW DESIGNS
NEW LITERATURE

"A" Battery Eliminator, DC-AC Inverters
Auto Radio Vibrators
See your jobber or write factory

ATR

AMERICAN TELEVISION & RADIO CO.
Quality Products Since 1931
SAINT PAUL 1, MINNESOTA—U. S. A.

BACKTALK

(continued)

tools that contributes to low cost of many of the cheaper receivers in this country.

As to overwhelming arguments for 405 lines, suffice it to point out that on the 20-inch tubes now becoming popular for use in even quite small rooms, the lines of such a system would be of the order of $\frac{3}{8}$ inch. The trend here has continually been one of greater definition—a progressive, not a retrogressive trend.

As I commented at the start, I submit these comments with a degree of humility, as befits a college student coming before the learned group that is the ELECTRONICS circulation. If I have at least shown that there might be another side to the discussion, I shall be satisfied.

ROBERT F. HOOPER
Student
Albion College
Albion, Michigan

Electronics Quiz

THIS month's puzzler was submitted by Robert C. Burns of Hicksville, Long Island. For this contribution, Burns will receive our check for \$5.00, as will all other contributors whose problems are accepted and published in this department.

This Month's Problem

Given the following circuit, and assuming a perfect battery and perfect capacitors,

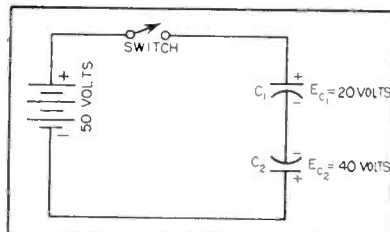

what will be the final capacitor voltages after the switch is closed?

Answer will appear next month.

Last Month's Problem

Last month's problem involved the charging of the capacitor in the circuit diagram of Fig. 1A. It was desired to determine the initial charging current flowing into the capacitor at the time the

MICO

Precision Apparatus

UHF COAXIAL WAVEMETERS



2-75
CENTIMETER
RANGE

MODEL 433 . . . 20 to 75 Centimeters

MODEL 501 . . . 4 to 20 Centimeters

MODEL 402A . . . 2 to 10 Centimeters

MODEL 402B . . . 2 to 10 Centimeters
(Reaction Type)

MICO INSTRUMENT CO.

76E TROWBRIDGE ST., CAMBRIDGE, MASS.

HERE'S BIG HELP
IN
TERMINAL WIRING!

The New
**JONES
FANNING
STRIP**

The correct wire to
correct terminal
every time!

Connections
are made
through Fanning
Strip,
on bench
or anywhere
apart from
barrier strip,
and quickly
slipped into
assembly.



9-141
Barrier
Strip

9-161
Fanning
Strip.
Pat.
applied
for.

Use with Jones Barrier Ter-
minal Strips, Nos. 141 and
142, for 1 to 20 terminals.

Simplifies soldering. Insures correct con-
nections. Saves time. Ideal for harness or
cable assembly. Brass terminals, cadmium
plated. Bakelite mounting. Send for com-
plete data.

Jones
HOWARD B. JONES DIVISION
CINCH MANUFACTURING CORPORATION
CHICAGO 24, ILLINOIS
SUBSIDIARY OF UNITED-CARR FASTENER CORP.

PROFESSIONAL SERVICES

AMERICAN SPEEDLIGHT CORP.
(AFFILIATED WITH J. G. SALTZMAN, INC.)
HARRY L. PARKER, PRESIDENT and
CHIEF ENGINEER
Specialist in Flash and Electronic Equipment
for Photography
Consultation—Development—Design and
Manufacture
480 Lexington Avenue New York 17, N. Y.

Professional Assistance . . .
in solving your most difficult problems in the specialized field of electronic devices is offered by consultants whose cards appear on this page.

PICKARD AND BURNS, INC.
Consulting Electronic Engineers
Analysis and Evaluation
of Radio Systems
Research, Development & Design
of Special Electronic Equipment
240 Highland Ave., Needham 94, Mass.

CROSBY LABORATORIES, INC.
Murray G. Crosby & Staff
Radio-Electronic Engineering,
Research & Development
FM, Communications, TV
Test Equipment
Offices, Laboratory & Model Shop at:
126 Herricks Rd., Mineola, N. Y.
Garden City 7-0284

HANSON-GORRILL-BRIAN INC.
Products & Mfg. Development
ELECTRICAL - ELECTRONIC
HYDRAULIC - MECHANICAL
One Continental Hill Glen Cove, N. Y.
Glen Cove 4-1922

ALBERT PREISMAN
Consulting Engineer
Television, Pulse Techniques, Video
Amplifiers, Phasing Networks,
Industrial Appliances
Affiliated with
MANAGEMENT-TRAINING ASSOCIATES
3308-14th St., N.W. Washington 10, D. C.

DUBROW DEVELOPMENT CO.
Design — Development — Mfr.
Quality Electronic Equipment
347 High St. Burlington, N. J.
Burlington 3-0446

R. W. HODGSON
PATENT-INVENTION RESEARCH & DEVELOPMENT ENGINEER SPECIALIZING
IN ELECTRONICS
Gadget-of-the-Month Club Bldg.
6600 Lexington Ave., Hollywood 38, Calif.
All mail to Box 874, Sherman Oaks, Calif.
Gladstone 9680 HUDson 2-2311 STate 4-9318

SKINNER, HARLAN AND IRELAND, INC.
Consulting Engineers
Specializing in Magnetic Materials and
Their Application
Office and Laboratory Indianapolis 7, Indiana

**EDGERTON, GERMESHAUSEN
& GRIER, INC.**
Consulting Engineer
Research Development and Manufacture
of Electronics and Stroboscope Equipment
Specialists in High-Speed Photography
160 Brookline Avenue, Boston 15, Mass.

HOGAN LABORATORIES, INC.
John V. L. Hogan, Pres.
Applied Research, Development, Engineering
Est. 1929. Exceptionally competent staff.
Electronics, Optics, Mechanisms, Facsimile
Communication, Electro-sensitive recording
media, Instrumentation.
155 Perry Street, New York 14 CHelsea 2-7855

ALFRED W. SUTTER
Purchasing Engineer
PURCHASING • EXPEDITING • CONTRACT
NEGOTIATIONS
CONSULTING AND ADMINISTERING
Systems and Methods • Inspecting
Facilities Surveys • Budgets
141 E. 44th St., N. Y. 17, N. Y. Murray Hill 2-2655

**ELECTRONIC ENGINEERING
CO. of CALIFORNIA**
Radio and Electronic Consulting and
Designing.
180 S. Alvarado Los Angeles
DUUnkrk 2-7353 California

MEASUREMENTS CORPORATION
Research & Manufacturing Engineers
Harry W. Houck Jerry B. Minter
John M. van Beuren
Specialists in the Design and
Development of Electronic Test Instruments
Boonton, N. J.

**THE TECHNICAL
MATERIEL CORPORATION**
Communications Consultants
Systems Engineering
General Offices and Laboratory
121 Spencer Place, Mamaroneck, N. Y.

**ERCO RADIO
LABORATORIES, INC.**
Radio Communications Equipment
Engineering - Design - Development - Production
Pioneers in Frequency Shift Telegraph
Garden City • Long Island • New York

A. JOHN MICHEL
Registered Patent Attorney
SPECIALIZING IN ELECTRONICS
15 Park Row, New York 38, N. Y. Tel. CO 7-9034

TELECHROME, INC.
Electronic Design Specialists
COLOR TELEVISION EQUIPMENT
Flying Spot Scanners, Color Synthesizers, Keyers,
Monitors, Oscilloscopes and Related Apparatus
J. R. Popkin-Curman, Pres. & Ch. Engr.
88 Merrick Rd. Amityville, L. I., N. Y.

GEORGE H. FATHAUER
Development and Design
of FM, TV, VHF Communications Equipment
Complete Laboratory and Model Shop Facilities
4005 E. Michigan St. Telephone
Indianapolis 1, Indiana BLackstone 1330

Eugene Mittelman, E.E., Ph.D.
Consulting Engineer & Physicist
High Frequency Heating—Industrial Electronics
Applied Physics and Mathematics
549 W. Washington Blvd. Chicago 6, Ill.
State 2-8021

FREDERICK P. WARRICK
Engineering Consultant
Development & Manufacture of High Speed
Moving Film Cameras for Oscillography &
Stroboscopic Photography.
1960 Graefield Road Birmingham, Michigan

EDWARD A. GAUGLER, Ph.D.
Consulting Physicist
Magnetic Materials and their Applications
419 Shepherd St. Chery Chase, Md.
Wisconsin 6106

NIAGARA ELECTRON LABORATORIES
CONSULTATION - DESIGN - CONSTRUCTION
MFG. THE THERMOCAP RELAY
Specializing in solution of problems of electronic
and electro-physical instrumentation for the re-
search or analytical laboratory. Industrial plant
problems also invited.
Andover, New York Cable Address: NIATRONLAB

WHEELER LABORATORIES, INC.
Radio and Electronics
Consulting—Research—Development
R-F Circuits—Lines—Antennas
Microwave Components—Test Equipment
Harold A. Wheeler and Engineering Staff
Great Neck, N. Y. Great Neck 2-7806

HERMAN LEWIS GORDON
Registered Patent Attorney
Patent Investigations and Opinions
Warner Building, Washington 4, D. C.
NAtional 2497

PHYSICAL RESEARCH ASSOCIATES
Consulting Physicists & Engineers
Arthur M. Vigilante, Director
Research, Development, Design and Manufacture
of Detection and Recording Systems, Industrial
and Analytical electro-physical instrumentation,
Dynamic Condenser Electrometers.
#1 Azurelee Drive Malibu 8444 Malibu, Calif.

YARDNEY LABORATORIES, INC.
Research - Design - Development
Electro-Chemical Generators of Energy
105 Chambers Street WOrth-2-3534, 35, 36
New York 7, N. Y.

WIDE BAND DIRECT COUPLED OSCILLOSCOPE

Tektronix Type 514-D

Bandwidth: DC—10 mc

Sensitivity: AC—.03 v/cm
DC—.3 v/cm

Sweep Range: .1 usec/cm—.01 sec/cm
continuously variable

Voltage Calibrator: Square wave,
0—50v in 6 ranges

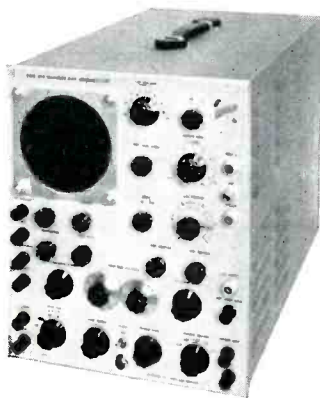

The advantages of the direct coupled oscilloscope are now available in the region of 10 mc. Not only is it possible to measure the duration and amplitude of a waveform, but also the D.C. level at which it occurs.

- Distributed type push-pull output amplifiers.
- All DC voltages electronically regulated.
- Triggered, recurrent or single sweeps.
- .25 μ sec signal delay network.
- Better than 5% accuracy of timing and amplitude.

Write or wire for complete specifications.

\$950.00

f. o. b. Portland,
Oregon



Cal. No. TEKTRONIX

712 S. E. HAWTHORNE BLVD. PORTLAND 14, OREGON

BACKTALK

(continued)

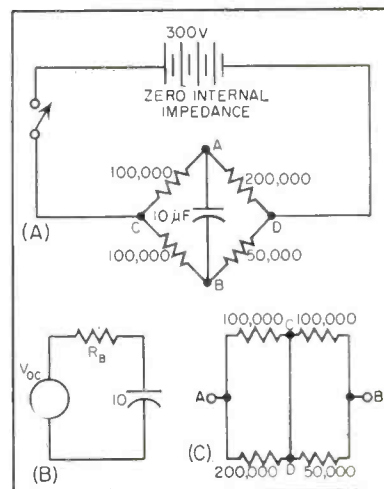

FIG. 1—Solution of last month's quiz problem

switch was closed, and also to determine the time constant of the circuit.

The answer submitted by the author of the problem is as follows: "By Thevenin's theorem, the circuit can be reduced to that shown in Fig. 1B where V_{oc} is the open-circuit voltage at AB (that is, with capacitor removed) and R_B is the output resistance (the resistance looking back into AB, with all sources of emf replaced by their internal resistance). Clearly, V_{oc} is 100 volts, and by Fig. 1C, R_B is 100,000 ohms. At the instant of closing the switch the capacitor appears as a short-circuit, and the initial current is V_{oc}/R_B or 1 ma. The time constant $= CR_B = 10 \times 10^{-6} \times 10^5 = 1$ second.

It is worth noting that the initial current can be found using Kirchhoff's Laws and replacing the capacitor by a short-circuit, but the time constant cannot be easily found in this manner.

Electronic Organ

DEAR SIRs:

SINCE the publication of my article entitled, "Gas-Diode Electronic Organ" (ELECTRONICS, Jan. 1951, p 70), two mistakes in diagrams have been brought to my attention. On page 72, Fig. 2, the lead marked --100 v should be connected to the ground bus. In Fig. 3 the waveforms should show initial discharge peaks at the beginning of each positive and negative half-cycle.

ROBERT M. STRASSNER
Monterey Park, Calif.

IN-RES-CO TYPES SM-15 & SM-30 WIRE WOUND RESISTORS

SUB-MINIATURE weather-tested midgets

Type SM-15 and SM-30 Resistors offer three vital advantages — sub-miniature size, weather resistant construction and high resistance. The elimination of center hole mounting and the inclusion of axial leads increases winding area and results in 25% greater resistance value than resistors of standard design. Special coating is moisture and fungus proof and designed to meet JAN-R-93 specifications. Sealed in Bakelite construction affords additional climatic protection. As ratings are conservative, types SM-15 and SM-30 can be specified with confidence for service under rigorous conditions.



TYPE SM-15
5/16" DIA. x 3/8" LG.



TYPE SM-30
5/16" DIA. x 3/4" LG.

INSTRUMENT RESISTORS CO.

COMMERCE
AVENUE



UNION
NEW JERSEY

ASK FOR THE NEW
RESISTOR HANDBOOK —
Contains complete data on
resistors for every purpose
and their recommended
applications. Please
make request on com-
pany letterhead.



APPLICATION-DESIGNED RESISTORS FOR ELECTRONICS AND INSTRUMENTATION

CONTACTS

FOR THE FIELD OF ELECTRONICS



FINE RIBBONS OF TUNGSTEN and Molybdenum
 Quality and accuracy in our fabrication of Tungsten & Molybdenum Ribbons have characterized our service to the Electronic industry.
 A development of
H. CROSS Co.
 15 Beekman St., New York 7, N. Y.



Manufacturers of
ELECTRONIC AND ELECTRICAL APPLIANCES • ELECTRONIC PROTOTYPES
BRUBAKER MANUFACTURING COMPANY
 9151 Exposition Drive • Los Angeles 34, California • TExas 0-5313

FOR MAINTENANCE OF MOBILE COMMUNICATIONS SYSTEMS
MICROMETER FM FREQUENCY MODULATION METER
LAMPKIN LABORATORIES, INC.
 Bradenton, Florida



MORE THAN 70 DIFFERENT TYPES & SIZES
MINIATURE BALL BEARINGS for application in precision mechanisms minimize friction and wear. High load capacity. Least weight and space. Special designs and complete engineering service for your application. Write for catalog E.



The nonmelting **SILICONE** insulating and waterproofing compound, stable at temperatures from **-70°F. to +400°F.**
MEETS ALL REQUIREMENTS OF AN-C-128a
 More water repellent than paraffin, Dow Corning 4 Compound is highly resistant to oxygen, ozone and to deterioration caused by corona discharge.
POWER FACTOR up to 10 megacycles... 0.001
VOLUME RESISTIVITY ohm centimeters... 10"
DIELECTRIC STRENGTH volts/mil... 500
Write Today!
 for your copy of our new booklet on Dow Corning 4 Compound, Address Dept. J



for switches and contacts in the **POWER INDUSTRY**



for **ELECTRONIC EQUIPMENT**



DOW CORNING CORPORATION, Midland, Michigan



FLUXES
 SODERING BRAZING & WELDING
L. B. ALLEN CO. INC. Chicago 31, Ill.
 6751 Bryn Mawr Ave.



MINIATURE Precision BEARINGS
 INCORPORATED
 KEENE, NEW HAMPSHIRE, U. S. A.

SUB-CONTRACTING MILITARY and COMMERCIAL
 receivers — test equipment
 transmitters — controls
 sub-assemblies
TELETRONICS LABORATORY, INC.
 Westbury, L. I., N. Y., Westbury 7-1028

This
CONTACTS
Section

supplements other advertising in this issue with these additional announcements of products essential to efficient and economical production and maintenance. Make a habit of checking this page, each issue.

Classified Advertising Division
ELECTRONICS

Shorted Turn Indicator
 MODEL 101C BULLETIN 42
 HUNTINGTON BEACH, CALIF.
KARTRON

EL-TRONICS, INC.
 Research, development, and manufacture of electronic equipment—a single model to large quantities.
 Write Today for Free Resume of Our Plant Facilities
 Specialists in Geiger-Muller equipment
 2647-67 N. Howard St.-Phila. 33, Pa. -GARfield 5-2026

We invite inquiries on



WRITE FOR CATALOG
REX RHEOSTAT CO.
 BALDWIN, L. I., N. Y.

EISLER Manufactures Complete Equipment for:



SPOT WELDERS, Electric, for 1/4 to 250 KVA.
 TELEVISION TUBE GLASS WORKING EQUIPMENT.
 TRANSFORMERS, Special and Standard Types.
 INCANDESCENT LAMP Manufacturing Equipment.
 FLUORESCENT TUBE Manufacturing Equipment.
 NEON SIGN MAKERS EQUIPMENT.
 ELECTRONIC EQUIPMENT, Vacuum Pumps, etc.
 WET GLASS SLICING and Cutting machines for Laboratory use.
EISLER ENGINEERING CO., Inc. 751 So. 13th St., Newark 3, N. J.

SEARCHLIGHT SECTION

EMPLOYMENT • BUSINESS • OPPORTUNITIES • EQUIPMENT—USED or RESALE

UNDISPLAYED RATE

\$1.50 a line, minimum 3 lines. To figure advance payment count 5 average words as a line. **EMPLOYMENT WANTED & INDIVIDUAL SELLING OPPORTUNITY** undisplayed advertising rate is one-half of above rate, payable in advance. **PROPOSALS** \$1.20 a line an insertion.

INFORMATION:

BOX NUMBERS count 1 line additional in undisplayed ads. **DISCOUNT 10%** if full payment is made in advance for four consecutive insertions of undisplayed ads (not including proposals). **EQUIPMENT WANTED OR FOR SALE** Advertisements acceptable only in Displayed Style.

DISPLAYED—RATE PER INCH

The advertising rate is \$12.80 per inch for all advertising appearing on other than a contract basis. Contract rates quoted on request. **AN ADVERTISING INCH** is measured 7/8 inch vertically on one column, 3 columns—30 inches—to a page.

ELECT.

NEW ADVERTISEMENTS received at the N. Y. Office, 330 W. 42 St., N. Y. 18, by July 2nd will appear in the August issue, subject to limitation of space available. The publisher cannot accept advertising in the Searchlight Section which lists the names of the manufacturers of resistors, capacitors, rheostats, and potentiometers or other names designed to describe such products.



RESEARCH - DEVELOPMENT - DESIGN

ENGINEERING WITH A FUTURE

The steady growth of several established research and development projects has created a number of exceptional engineering opportunities with a future.

PHYSICISTS—ENGINEERS

Positions are now available in our organization for qualified physicists and engineers with backgrounds in circuit analysis, microwaves, servomechanisms, analog computers, etc. Openings exist at several levels with salaries dependent on education, ability, and experience.

If you are qualified and interested in a position which combines stability and unusual opportunity, write, giving full details to Mr. C. G. Jones, Manager, Salary Personnel.

GOOD YEAR
AIRCRAFT CORPORATION

Akron 15, Ohio

WANTED

2 ELECTRICAL ENGINEERS

The Taylor-Winfield Corporation, 1052 Mahoning Avenue, N.W., Warren, Ohio (a leading manufacturer of electric resistance welding machines) has positions available for two recently graduated electrical engineers.

One position involves work of a design and developmental nature on industrial electronic controls to be used with welding equipment. Basically the duties are those of a project engineer working under supervision to amend theoretical designs, make breadboard analyses and then follow by testing of pilot models. On completion of a successful design proven by tests, complete detailed engineering must be prepared for release to the manufacturing department.

The second position involves work of an inspection and test nature associated with field service. Controls, after selection by the Engineering Department are connected to welders and the proper functioning of the welding equipment studied. After physically functioning correctly, actual welding of sample parts is performed. In the more complicated equipment, field service is undertaken to allow the user to rapidly set up equipment and obtain the desired results. This is an excellent opportunity to become familiar with electrical components used in industry, with industrial electronic controls, and with methods of manufacture of many products by visits to plants in which Taylor-Winfield equipment is used.

If interested, please contact the Personnel Department, submitting an analysis of your training and experience in order that a personal interview may be arranged.

PHILADELPHIA AREA

Aircraft Industry

ELECTRONIC ENGINEERS

—All Grades—

Men whose education and interest or experience qualifies them for the development or design of airborne or ground radio, radar, or other electronic equipment can work under ideal conditions. We have openings in our small, efficient group (under 20 people) where the work is personalized and individual ability can be recognized and rewarded.

Write or telephone

Chief Engineer

Kellett Aircraft Corporation
Central Airport, Camden 11, N. J.
Merchantville 8-4800
Founded 1929

REPLIES (Box No.): Address to office nearest you
NEW YORK: 330 W. 42nd St. (18)
CHICAGO: 520 N. Michigan Ave. (11)
SAN FRANCISCO: 68 Post St. (4)

EMPLOYMENT SERVICE

SALARIED PERSONNEL, \$3,000-\$25,000. This confidential service, established 1927, is geared to needs of high grade men who seek a change of connection under conditions assuring, if employed, full protection to present position. Send name and address only for details. Personal consultation invited. Jira Thayer Jennings, Dept. L, 241 Orange St., New Haven, Conn.

(Continued on page 285)

Engineers . . .
 Physicists
 Chemists
 Metallurgists

A Reminder
 from
**GENERAL
 ELECTRIC**

Tremendous material resources
 . . . the stimulation of highly crea-
 tive work . . . long-range security
 and professional recognition . . .
 these are but a few of the assets
 General Electric offers you in un-
 usual positions now available in:

Advanced Development, Design,
 Field Service and
 Technical Writing.

If you have a Bachelor's or Advanced
 Degree in Electrical or Mechanical Engi-
 neering, Physics, Metallurgy or Physical
 Chemistry and experience in the Elec-
 tronics Industry, you can expand your
 training and experience to the fullest in
 openings in connection with:

- .. MILITARY RADIO & RADAR
- .. MOBILE COMMUNICATION
- .. MULTIPLEX MICROWAVE
 COMMUNICATIONS
- .. ELECTRONIC COMPONENTS
- .. TELEVISION, TUBES
 and ANTENNAS.

Please send resume to:
 TECHNICAL PERSONNEL
 ELECTRONICS PARK

GENERAL  ELECTRIC
 Syracuse, New York

OPPORTUNITIES IN RESEARCH AND DEVELOPMENT

IN
 BASIC AND APPLIED
 PHYSICS
 ELECTRONICS
 MATHEMATICS
 MECHANICAL ENGINEERING
 AERONAUTICAL SCIENCES AND ENGINEERING

PERMANENT POSITIONS FOR QUALIFIED PERSONNEL
 EXPERIENCED DESIRABLE BUT NOT ESSENTIAL
 WORK VITAL TO NATIONAL DEFENSE

THE LABORATORY OFFERS THE ADVANTAGES OF
 UNIVERSITY ATMOSPHERE AND CONTACTS, EXCEL-
 LENT RESEARCH FACILITIES, AND SALARIES COM-
 PARABLE WITH INDUSTRY.

CORNELL AERONAUTICAL LABORATORY, INC.

A Non-Profit Research Corporation, Wholly Owned by Cornell University
 P.O. BOX 235, BUFFALO 21, NEW YORK

INQUIRIES CONFIDENTIAL

IF

YOU are an engineer or a physicist and
YOU have skills and interests related to
 diverse armament development projects and
YOU are capable of assuming greater responsibility . . . and
YOU prefer the personalized attitudes and policies
 and the demands for ingenuity and versatility
 offered by a small progressive company—

WE would like to make your acquaintance

 **AIRCRAFT
 ARMAMENTS INC.**
 4415 REISTERSTOWN RD.
 BALTIMORE 15, MARYLAND

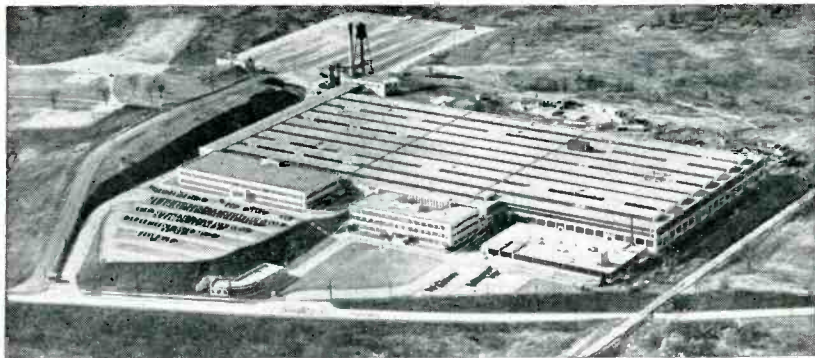

Development Engineers for Electronic Aircraft Armament

ELECTRONIC INSTRUMENTATION • ELECTRONIC COMPONENTS •
SERVOMECHANISMS • RADAR • ELECTRONIC PACKAGING •
CALIBRATION AND TESTING ENGINEERS FOR PRODUCTION

Job openings range from recent graduates to Engineers with years of experience. Attractive employee benefits include group insurance and pension plans; paid holidays and vacations.

Send complete resume, listing salary requirements and availability, to:

Technical Employment Supervisor, Station 483-D

THE EMERSON ELECTRIC MFG. CO.

8100 Florissant • St. Louis 21, Missouri

LEADERS IN THE ELECTRICAL INDUSTRY SINCE 1890



Wanted ENGINEERS AND SCIENTISTS

Unusual opportunities for outstanding and experienced men.

These top positions involve preliminary and production design in advanced military aircraft and special weapons, including guided missiles.

Immediate positions include:

- Electronic project engineers
 - Electronic instrumentation engineers
 - Radar engineers
 - Flight test engineers
 - Stress engineers
 - Aero- and thermodynamicists
 - Servo-mechanists
 - Power plant installation designers
 - Structural designers
 - Electro-mechanical designers
 - Electrical installation designers
- Excellent location in Southern California, Generous allowance for travel expenses.*

Write today for complete information on these essential, long-term positions. Please include resume of your experience & training. Address inquiry to Director of Engineering,

NORTHROP AIRCRAFT, INC.

1009 E. Broadway

Hawthorne (Los Angeles County) California

ELECTRONIC ENGINEERS

AND

PHYSICISTS

FOR RESEARCH IN
TELEVISION AND ALLIED
FIELDS

EXCELLENT OPPORTUNITIES
FOR SPECIALISTS IN

- UHF CIRCUITS
- CATHODE RAY TUBE DESIGN
- ELECTRONIC CIRCUITS
- VACUUM TUBE TECHNIQUES

QUALIFIED APPLICANTS ARE INVITED
TO WRITE:

MANAGER, TECHNICAL EMPLOYMENT

WESTINGHOUSE ELECTRIC CORP.

306 4TH AVE., PITTSBURGH, PA.



BY BELL AIRCRAFT



Supersonic Aircraft
(X-1)



Jet-Propelled Fighter in
U. S. (F-59)



Commercially Licensed
Helicopter

BELL AIRCRAFT CORPORATION

NEEDS

**SCIENTISTS!
ENGINEERS!
DESIGNERS!
DRAFTSMEN!**

to accept the challenge of development work in...

**LONG RANGE
PROGRAMS**

on

GUIDED MISSILES

**AIR-BORNE
ELECTRONIC EQUIP'T**

ROCKET ENGINES

HELICOPTERS

CONVERTIPLANES

Scientific or engineering degree and extensive technical experience required.

INQUIRE NOW!

Manager, Engineering Personnel

BELL *Aircraft*
CORPORATION
P.O. BOX 1 BUFFALO 5, N. Y.

BENDIX RADIO DIVISION



TV RECEIVER DESIGN ENGINEERS

—Progressive TV Design Section has excellent opportunity for highly experienced men with proven ability. Desirable openings also available for promising young engineers. We will be pleased to discuss salaries at all levels.

ELECTRONICS ENGINEERS — At all salary and experience levels.

RESEARCH ON: Antennae, Servo-mechanisms, Microwave ccts. and other phases of communications and navigation equipment.

PRODUCTION DESIGN OF: Military and commercial communications and navigation equipment.

FIELD ENGINEERS — Supervise installation and maintenance of radio and radar equipment. Factory training will be given. Base salaries from \$4200 to \$6900 per year. 25% bonus for time spent overseas. Traveling and living expenses paid by Bendix. Insurance plan.

TEST AND INSPECTION ENGINEERS — Practical knowledge of radio, radar, or TV manufacturing processes. Good knowledge of radio fundamentals essential. Base salaries from \$3900 to \$5880.

TECHNICAL WRITERS — Knowledge of radar fundamentals or radio required. Work closely with engineers to gather material for instruction and maintenance manuals. Base salaries from \$3400 to \$4300.

LABORATORY TECHNICIANS — Require knowledge of radio fundamentals and skill in use of measuring instruments and laboratory equipment. Previous industrial experience essential. Salaries from \$262 to \$321 per month.

BASE SALARIES FOR ALL POSITIONS LISTED ABOVE ARE SUPPLEMENTED BY UP TO 30% FOR REGULARLY SCHEDULED 48-HOUR WEEK.

Housing is no problem in Baltimore.

Excellent group insurance and family hospitalization plan.

Attractive retirement plan for professional personnel.

Write for application:

Engineering Personnel Supervisor
Department E
BENDIX RADIO DIVISION of
Bendix Aviation Corporation
Baltimore 4, Maryland
TOWSON 2200

ATOMIC ENERGY INSTALLATION NEEDS ELECTRONICS ENGINEERS

Two to ten years' experience in research, design, development or test. Patent history desirable but not necessary. A variety of positions open for men, with Bachelor's or advanced degree, qualified in one or more of the following fields:

- RELAYS
- PULSE CIRCUITS
- SERVO-MECHANISMS
- LOW POWER APPLICATION
- TELEMETERING
- UHF TECHNICIANS
- INSTRUMENTATION
- QUALITY CONTROL

TEST EQUIPMENT RELATING TO THE ABOVE

CAREER DRAFTSMEN

EXPERIENCED CAREER DRAFTSMEN WITH NO COLLEGE DEGREE.

These are PERMANENT POSITIONS with Sandia Corporation in Albuquerque, New Mexico. Sandia Laboratory is operated by Sandia Corporation, a subsidiary of Western Electric Company, under contract with the ATOMIC ENERGY COMMISSION. This laboratory offers good working conditions and liberal employee benefits, including paid vacations, sick leave, and a retirement plan.

Albuquerque, center of a metropolitan area of 150,000, is located in the Rio Grande Valley, one mile above sea level. The "Heart of the Land of Enchantment." Albuquerque lies at the foot of the Sandia Mountains, which rise to 11,000 feet. Climate is sunny, mild and dry the year 'round.

Make Application to:

PROFESSIONAL EMPLOYMENT DIVISION SANDIA CORPORATION

SANDIA BASE

ALBUQUERQUE, NEW MEXICO

ELECTRONIC ENGINEERS

SENIOR ENGINEERS or PHYSICISTS Degree and experience in Radar, Pulse Circuits, Digital or Analogue Computers, or Servomechanisms JUNIOR ENGINEERS and recent graduate in EE or Physics.

ELECTRONIC ENGINEERING COMPANY OF CALIFORNIA

180 S. Alvarado St. Los Angeles 4, Calif.

ELECTRONIC ENGINEER

At least three (3) years post-college experience in development, DC amplifier, digital computers, pulse and servo design. Established Company, New York City.

P-9662, Electronics
330 W. 42 St., New York 18, N. Y.

WANTED

Research and Development Engineers and Physicists with educational background in mechanical, electrical or electronic engineering, physics or engineering physics for openings in plant and laboratory instrumentation, physical measurements, geophysics, and industrial electronics. Prefer persons with two to four years experience in experimental research design and development of instruments, intricate mechanisms, electronic apparatus, optical equipment, servo-mechanisms or allied fields. Positions are of immediate and permanent importance to our operations.

Write Personnel Director

Research and Development Department
PHILLIPS PETROLEUM COMPANY
Bartlesville, Oklahoma

ELECTRONIC ENGINEERS

who have at least 5 years of good experience in Nucleonics, Radar, Guided Missiles, Computers or Allied fields are desired immediately for development work on new instrumentation. These positions give opportunity to exercise judgment and initiative. Ours is a growing concern with progressive ideas. Those associated with this company have real opportunities for advancement. We will be pleased to hear from qualified men. Please send resume to Personnel Director and phone for appointment.

Tracerlab 130 High Street, Boston, Mass.

TUBE ENGINEERS

PRODUCTION & DEVELOPMENT
With transmitting & rectifier tube experience. Write direct stating experience, salary requirements.

TAYLOR TUBES, INC.
2312 W. Wabansia Ave., Chicago 47, Ill.

PHYSICIST WANTED

Experienced in the development of electronic storage devices. Excellent opportunity with progressive, established Eastern manufacturer. Moving expenses paid. Interview arranged upon receipt of detailed resume.

P-9913, Electronics
330 W. 42 St., New York 18, N. Y.

Electrical ENGINEERS or PHYSICISTS

Microwave . . .

- to develop test sets and methods on long-distance radio relay equipment.
- Experienced in performance of amplifiers, modulators, filters and cavities at microwave frequencies.

Filters and Networks . . .

- to develop manufacturing facilities and methods of manufacture.

Test . . .

- to develop test facilities for the manufacture of communication and television transmission. Basic knowledge of transmission theory required.

Minimum Qualification B.S. Degree or Equivalent

Write Dept. E giving details of qualifications, experience and salary expected, or

Apply in Person
Employment Department
Monday through Saturday,
8:30 AM to 3:30 PM

Applicants must furnish proof of citizenship and social security number. Veterans must present discharge papers.

WESTERN ELECTRIC CO.

- 100 Central Ave., Kearny, N. J.
- SUPPLY UNIT of the BELL SYSTEM

A CHALLENGE to Outstanding ENGINEERS PHYSICISTS DESIGNERS

Take Advantage of the Present to Assure Your Future

POSITIONS with SCOPE and IMAGINATION NOW OPEN

Minimum Requirements Are:

Four years experience in advanced research and development on Radar Systems, Computers, Wave Guide and Antennas, Fire Control, Moving Target Indication, Servomechanisms, Pulse Techniques, Gyroscopic Equipment and Related Fields.

Please send resume and salary requirements to:

The W. L. MAXSON CORPORATION

460 W. 34th St., NEW YORK 1, N. Y.

AC SPARK PLUG DIVISION

of

GENERAL MOTORS CORPORATION

PRECISION INSTRUMENT PLANT

Positions now available for highest caliber personnel in the field of airborne automatic electro-mechanical control equipment.

MECHANICAL DESIGN ENGINEERS ELECTRONIC ENGINEERS SERVO ENGINEERS JUNIOR ENGINEERS

New and expanding division of an established firm with 20 years of successful experience in the instrument field. Work involved deals with the manufacture and development of highly complex equipment of the most advanced type.

Write or Apply

AC Spark Plug Division
GENERAL MOTORS CORPORATION
1925 E. Kenilworth Place
Milwaukee 2, Wisconsin

RESEARCH PERSONNEL

Research Laboratories of organization engaged in equipment development, process engineering and fundamental research has positions available as follows:

1. Senior Physicist or Physical Chemist for theoretical and experimental work on the behavior of fine particles in fluid media. Must be good experimentalist.
2. Senior Physicist having practical experience in the field of electronics and servomechanisms. Must be capable of completely developing electronic devices from the theoretical design through to a finished product.
3. Junior Physicist having a strong background in theoretical work as well as possessing experimental aptitude.

Please give education, experience, personal details and salary requirements in first letter.

THE SHARPLES CORPORATION
2300 Westmoreland St. Philadelphia, Pennsylvania
Reply to
THE SHARPLES RESEARCH LABORATORY
424 West 4th St. Bridgeport, Pennsylvania

CALIFORNIA

Manufacturers Representative

Growing organization has capacity for another product in the electro-mechanical field. An established sales and engineering service of unusual quality.

H. G. WEIGHTMAN
Brown Professional Bldg.
140 S. Glenoaks Blvd. Burbank, Calif.

POSITIONS WANTED

GRADUATE E. E. with heavy technical and administrative experience in radio and electronic engineering seeks position as chief engineer of small or medium-sized company or assistant chief of larger. Will also consider position as technical group leader. Within commuting distance of Paterson, N. J. PW-9965, Electronics.

EXECUTIVE ENGINEER, extensive background in electronic measurement and control, wants challenging position. Profit-sharing incentive preferred. PW-9973, Electronics.

DEVELOPMENT AND design engineer. 10 years engineering experience in Search and Fire Control Radar, Pulse, Telemetry and microwave circuit design. U. H. F. and microwave antenna development. PW-9817, Electronics.

ELECTROMECHANICAL PROJECT Engineer —30, B.S., M.S., 10 years of experience in development of automatic control systems (servos), precision instruments and production. Aggressive. Desires responsible position with progressive company. PW-9979, Electronics.

GRADUATE E.E.—2 yrs. design of precision electronic meas. mach. in crystal factory, 2 yrs. as senior elec. design engr. for resistance welders and 6 yrs. communications. What I don't know, I catch on quickly. PW-9998, Electronics.

SALES EXECUTIVE, Instrument Specialist, excellent record of creative selling and management, seeks opportunity to build future with small or medium sized Eastern manufacturer. Qualifications include large personal government and commercial sales organization, planning, contract negotiations, writing, advertising, E.E. PW-1017, Electronics.

TECHNICAL ADVERTISING Specialist available on part-time or consulting basis for layout, preparation, writing, and complete production of advertising, brochures, literature, catalogs. N. Y. Metrop. area. PW-1018, Electronics.

Ph.D. AVAILABLE for short-term overseas work. Eight years electronic research and development. Unusual knowledge of components and construction techniques. PW-9922, Electronics.

SELLING OPPORTUNITY WANTED

LINES WANTED, electronic and electrical components and equipment. Missouri and Southern Illinois. Established representative. RA-1023, Electronics.

PATENTS

Consult: Z. H. Polachek, Reg. Pat. Attorney, 1234 Broadway, New York 1, N. Y.

EMPLOYER WANTED

By

ELEC. ENGR.

Experienced in Service, Development, Electronics & Automatic Machines. Ability to Inspire Employees & Direct Development.

35 Years Old

WHAT ARE YOUR PLANS?

PW-1012, Electronics

520 No. Michigan Ave. Chicago 11, Ill.

SALES MANAGER AVAILABLE

Thoroughly experienced in all phases of gov't. and comm. sales engineering and management. EE. Seeks new connection on salary or participating basis.

SA-1020 ELECTRONICS

330 W. 42nd St.

N. Y. 18

EXPERIENCED electronic and mechanical engineers

Organization established in 1942. Electronic research, development, and production must expand to meet long-term, pre-Korea commitments. Openings in all branches of electronics, including

RECEIVERS TRANSMITTERS
ANTENNAS RADARS
RELATED EQUIPMENT

Positions available for men with at least 5 yrs experience

Write or telephone Howard J. Gresens at

Airborne Instruments Laboratory
INCORPORATED

160 Old Country Road, Mineola

Long Island, N. Y.

Garden City 7-6880

Admiral Electronic Engineers

Needed Immediately for
Long Range Research Program

Admiral Corporation, one of America's largest electronic and appliance manufacturers, needs electronic engineers for long range research program covering both consumer as well as governmental projects. Project and senior project engineers with minimum of two to five years' experience needed immediately. Top pay with excellent opportunities for advancement. Send resume of experience and education to Engineering Personnel Manager . . .

ADMIRAL CORPORATION

Dept. E, Chicago 47.

SEARCHLIGHT SECTION

Coaxial relay K-101—SPDT—24v DC.....\$ 6.59
 Set of 83-1XP coax-connectors for above..... .89
 RG59U coaxial cable—75 ohm
 150' roll.....\$11.95 300' roll..... 22.50
 300 ohm twin lead. 300' minimum—per ft..... .03
 Sigma plate relay 8000 ohm—SPDT..... 2.75



1000KC crystal ET cut.....\$3.95
 3"scope shield..... 1.29
 2 speed dial drive for 1/4" shaft ratios 5:1 to 1. .39
 ATC 100 mmfd air trimmer screwdriver shaft.... .29
 Centralab 850 S 50MMF 5KV button cond..... .39
 Rotary switch mycalex, 2 deck SP3T..... .39

TUBES!! BRAND NEW! STANDARD BRANDS! NO SECONDS! COMPARE! TUBES!!

0A3/VR75 \$1.69	3C24 ..\$2.25	227A/5C27 \$5.95	812H ..\$6.90	8014 ..\$29.95	OA2 ..\$2.95	5Z4 ..\$1.40	6SN7GT ..\$1.60	12SL7 ..\$1.10
0C3/VR90 1.29	3C31/C1B. 3.49	249C .. 3.95	813 .. 8.95	8020 .. 1.29	0A4G .. 1.35	6A3 .. 1.35	6SN7GT .. 1.15	12SN7 .. 1.25
0B3/VR105 1.49	3C45 .. 19.95	250R .. 12.95	814 .. 2.95	8025 .. 5.95	0A5 .. 1.45	6AL4 .. 1.45	6SN7GT .. 1.48	12SR7 .. 1.25
1B2 .. 1.29	3CP1 .. 2.25	250TL .. 21.50	816 .. 1.30	9002 .. 2.25	0A .. .90	6A7 .. 1.10	6ST7 .. 1.45	12Z3 .. 1.10
1B23 .. 12.50	3DP1 .. 4.95	274A .. 5.50	828 .. 12.75	9003 .. 2.25	1A3 .. 1.32	6A8 .. 1.25	6SU7GT .. 2.25	14A4 .. 1.20
1B24 .. 9.95	3DP1A .. 6.95	274B .. 2.65	829 .. 12.95	9004 .. 7.75	1A4 .. 1.30	6A87 .. 1.49	6SV7 .. 1.45	14A7 .. 1.15
1B26 .. 24.50	3DP1A-S2A .. 8.95	276A .. 9.95	829B .. 14.95	9005 .. 2.95	1A5GT .. 1.05	6AC5GT .. 1.40	6T7 .. 1.65	14F8 .. 1.15
1B29 .. 2.75	3E29 .. 14.95	294A .. 2.98	830 .. 12.95	9006 .. .45	1A6 .. 1.10	6AC7 .. 1.65	6T8 .. 1.65	14F8 .. 1.15
1B32 .. 2.95	3F17 .. 3.95	294B .. 2.98	831 .. 12.95	9007 .. 2.95	1A7GT .. 1.35	6AD7GT .. 1.45	6U5G .. 1.25	14F8 .. 1.15
1B36 .. 24.96	3GP1 .. 4.75	304TH .. 27.50	832 .. 12.95	9008 .. 2.95	1A8 .. 1.35	6AE6G .. 1.05	6U6GT .. 1.25	14H7 .. 1.20
1B38 .. 32.50	3HP7 .. 3.95	304TL .. 29.95	832A .. 12.95	9009 .. 2.95	1A85 .. 1.85	6AF6G .. 1.45	6U7G .. 2.00	14H7 .. 1.20
1N21 .. 1.35	4A70 .. 1.95	309R .. 34.95	832B .. 12.95	9010 .. 2.95	1A85/8016 .. 1.85	6AG5 .. 2.65	6V6GT .. 1.45	14H7 .. 1.20
1N21A .. 2.25	4A75A .. 2.95	307A/RK75 5.95	833 .. 12.95	9011 .. 2.95	1A85/25S .. 1.85	6AG7 .. 1.65	6V8GT .. 1.50	14Q7 .. 1.15
1N21B .. 4.25	4A250A .. 29.95	310A .. 8.95	833A .. 12.95	9012 .. 2.95	1A85/25S .. 1.85	6AH9 .. 2.10	6W4 .. 1.15	14R7 .. 1.30
1N22 .. 2.25	4B22 .. 9.95	310A/B .. 24.50	833B .. 12.95	9013 .. 2.95	1A85/25S .. 1.85	6AK5 .. 2.25	6X5GT .. 1.05	25L8GT .. 1.20
1N23A .. 3.25	4B24 .. 7.95	327A/6C37 4.95	834 .. 12.95	9014 .. 2.95	1A85/25S .. 1.85	6AK9 .. 1.85	6Y5G .. 1.55	25Z6GT .. 1.05
1N23B .. 1.69	4B26/2000 8.95	331A .. 12.95	835 .. 12.95	9015 .. 2.95	1A85/25S .. 1.85	6AL5 .. 1.25	6Z4/XXL .. 1.20	25 .. .98
1N34 .. 1.40	4B28 .. 4.95	350A .. 8.95	835A .. 12.95	9016 .. 2.95	1A85/25S .. 1.85	6AL5 .. 1.25	7A4 .. 1.10	28D7 .. .98
1N34A .. 1.40	4B32 .. 4.95	350B .. 8.95	836 .. 12.95	9017 .. 2.95	1A85/25S .. 1.85	6AL5 .. 1.25	7A6 .. 1.10	28D7 .. .98
1P23 .. 1.75	4C5A .. 3.95	368AS .. 7.95	836A .. 12.95	9018 .. 2.95	1A85/25S .. 1.85	6AL5 .. 1.25	7A7 .. 1.10	28D7 .. .98
1P24 .. 1.79	4C5B .. 34.50	371A .. 1.49	837 .. 12.95	9019 .. 2.95	1A85/25S .. 1.85	6AL5 .. 1.25	7A8 .. 1.10	28D7 .. .98
1P26 .. 2.95	4E27/257B 17.95	371B .. .98	838 .. 12.95	9020 .. 2.95	1A85/25S .. 1.85	6AL5 .. 1.25	7B4 .. 1.10	28D7 .. .98
2A1 .. 1.95	4F10 .. 3.95	388A .. 2.75	839 .. 12.95	9021 .. 2.95	1A85/25S .. 1.85	6AL5 .. 1.25	7B4 .. 1.10	28D7 .. .98
2A1 .. 1.95	5A1 .. 3.69	393A .. 6.95	840 .. 12.95	9022 .. 2.95	1A85/25S .. 1.85	6AL5 .. 1.25	7B4 .. 1.10	28D7 .. .98
2A1 .. 1.95	5A1 .. 3.69	394A .. 6.95	841 .. 12.95	9023 .. 2.95	1A85/25S .. 1.85	6AL5 .. 1.25	7B4 .. 1.10	28D7 .. .98
2A1 .. 1.95	5A1 .. 3.69	395A .. 6.95	842 .. 12.95	9024 .. 2.95	1A85/25S .. 1.85	6AL5 .. 1.25	7B4 .. 1.10	28D7 .. .98
2A1 .. 1.95	5A1 .. 3.69	396A .. 6.95	843 .. 12.95	9025 .. 2.95	1A85/25S .. 1.85	6AL5 .. 1.25	7B4 .. 1.10	28D7 .. .98
2A1 .. 1.95	5A1 .. 3.69	397A .. 6.95	844 .. 12.95	9026 .. 2.95	1A85/25S .. 1.85	6AL5 .. 1.25	7B4 .. 1.10	28D7 .. .98
2A1 .. 1.95	5A1 .. 3.69	398A .. 6.95	845 .. 12.95	9027 .. 2.95	1A85/25S .. 1.85	6AL5 .. 1.25	7B4 .. 1.10	28D7 .. .98
2A1 .. 1.95	5A1 .. 3.69	399A .. 6.95	846 .. 12.95	9028 .. 2.95	1A85/25S .. 1.85	6AL5 .. 1.25	7B4 .. 1.10	28D7 .. .98
2A1 .. 1.95	5A1 .. 3.69	400A .. 6.95	847 .. 12.95	9029 .. 2.95	1A85/25S .. 1.85	6AL5 .. 1.25	7B4 .. 1.10	28D7 .. .98
2A1 .. 1.95	5A1 .. 3.69	401A .. 6.95	848 .. 12.95	9030 .. 2.95	1A85/25S .. 1.85	6AL5 .. 1.25	7B4 .. 1.10	28D7 .. .98
2A1 .. 1.95	5A1 .. 3.69	402A .. 6.95	849 .. 12.95	9031 .. 2.95	1A85/25S .. 1.85	6AL5 .. 1.25	7B4 .. 1.10	28D7 .. .98
2A1 .. 1.95	5A1 .. 3.69	403A .. 6.95	850 .. 12.95	9032 .. 2.95	1A85/25S .. 1.85	6AL5 .. 1.25	7B4 .. 1.10	28D7 .. .98
2A1 .. 1.95	5A1 .. 3.69	404A .. 6.95	851 .. 12.95	9033 .. 2.95	1A85/25S .. 1.85	6AL5 .. 1.25	7B4 .. 1.10	28D7 .. .98
2A1 .. 1.95	5A1 .. 3.69	405A .. 6.95	852 .. 12.95	9034 .. 2.95	1A85/25S .. 1.85	6AL5 .. 1.25	7B4 .. 1.10	28D7 .. .98
2A1 .. 1.95	5A1 .. 3.69	406A .. 6.95	853 .. 12.95	9035 .. 2.95	1A85/25S .. 1.85	6AL5 .. 1.25	7B4 .. 1.10	28D7 .. .98
2A1 .. 1.95	5A1 .. 3.69	407A .. 6.95	854 .. 12.95	9036 .. 2.95	1A85/25S .. 1.85	6AL5 .. 1.25	7B4 .. 1.10	28D7 .. .98
2A1 .. 1.95	5A1 .. 3.69	408A .. 6.95	855 .. 12.95	9037 .. 2.95	1A85/25S .. 1.85	6AL5 .. 1.25	7B4 .. 1.10	28D7 .. .98
2A1 .. 1.95	5A1 .. 3.69	409A .. 6.95	856 .. 12.95	9038 .. 2.95	1A85/25S .. 1.85	6AL5 .. 1.25	7B4 .. 1.10	28D7 .. .98
2A1 .. 1.95	5A1 .. 3.69	410A .. 6.95	857 .. 12.95	9039 .. 2.95	1A85/25S .. 1.85	6AL5 .. 1.25	7B4 .. 1.10	28D7 .. .98
2A1 .. 1.95	5A1 .. 3.69	411A .. 6.95	858 .. 12.95	9040 .. 2.95	1A85/25S .. 1.85	6AL5 .. 1.25	7B4 .. 1.10	28D7 .. .98
2A1 .. 1.95	5A1 .. 3.69	412A .. 6.95	859 .. 12.95	9041 .. 2.95	1A85/25S .. 1.85	6AL5 .. 1.25	7B4 .. 1.10	28D7 .. .98
2A1 .. 1.95	5A1 .. 3.69	413A .. 6.95	860 .. 12.95	9042 .. 2.95	1A85/25S .. 1.85	6AL5 .. 1.25	7B4 .. 1.10	28D7 .. .98
2A1 .. 1.95	5A1 .. 3.69	414A .. 6.95	861 .. 12.95	9043 .. 2.95	1A85/25S .. 1.85	6AL5 .. 1.25	7B4 .. 1.10	28D7 .. .98
2A1 .. 1.95	5A1 .. 3.69	415A .. 6.95	862 .. 12.95	9044 .. 2.95	1A85/25S .. 1.85	6AL5 .. 1.25	7B4 .. 1.10	28D7 .. .98
2A1 .. 1.95	5A1 .. 3.69	416A .. 6.95	863 .. 12.95	9045 .. 2.95	1A85/25S .. 1.85	6AL5 .. 1.25	7B4 .. 1.10	28D7 .. .98
2A1 .. 1.95	5A1 .. 3.69	417A .. 6.95	864 .. 12.95	9046 .. 2.95	1A85/25S .. 1.85	6AL5 .. 1.25	7B4 .. 1.10	28D7 .. .98
2A1 .. 1.95	5A1 .. 3.69	418A .. 6.95	865 .. 12.95	9047 .. 2.95	1A85/25S .. 1.85	6AL5 .. 1.25	7B4 .. 1.10	28D7 .. .98
2A1 .. 1.95	5A1 .. 3.69	419A .. 6.95	866 .. 12.95	9048 .. 2.95	1A85/25S .. 1.85	6AL5 .. 1.25	7B4 .. 1.10	28D7 .. .98
2A1 .. 1.95	5A1 .. 3.69	420A .. 6.95	867 .. 12.95	9049 .. 2.95	1A85/25S .. 1.85	6AL5 .. 1.25	7B4 .. 1.10	28D7 .. .98
2A1 .. 1.95	5A1 .. 3.69	421A .. 6.95	868 .. 12.95	9050 .. 2.95	1A85/25S .. 1.85	6AL5 .. 1.25	7B4 .. 1.10	28D7 .. .98
2A1 .. 1.95	5A1 .. 3.69	422A .. 6.95	869 .. 12.95	9051 .. 2.95	1A85/25S .. 1.85	6AL5 .. 1.25	7B4 .. 1.10	28D7 .. .98
2A1 .. 1.95	5A1 .. 3.69	423A .. 6.95	870 .. 12.95	9052 .. 2.95	1A85/25S .. 1.85	6AL5 .. 1.25	7B4 .. 1.10	28D7 .. .98
2A1 .. 1.95	5A1 .. 3.69	424A .. 6.95	871 .. 12.95	9053 .. 2.95	1A85/25S .. 1.85	6AL5 .. 1.25	7B4 .. 1.10	28D7 .. .98
2A1 .. 1.95	5A1 .. 3.69	425A .. 6.95	872 .. 12.95	9054 .. 2.95	1A85/25S .. 1.85	6AL5 .. 1.25	7B4 .. 1.10	28D7 .. .98
2A1 .. 1.95	5A1 .. 3.69	426A .. 6.95	873 .. 12.95	9055 .. 2.95	1A85/25S .. 1.85	6AL5 .. 1.25	7B4 .. 1.10	28D7 .. .98
2A1 .. 1.95	5A1 .. 3.69	427A .. 6.95	874 .. 12.95	9056 .. 2.95	1A85/25S .. 1.85	6AL5 .. 1.25	7B4 .. 1.10	28D7 .. .98
2A1 .. 1.95	5A1 .. 3.69	428A .. 6.95	875 .. 12.95	9057 .. 2.95	1A85/25S .. 1.85	6AL5 .. 1.25	7B4 .. 1.10	28D7 .. .98
2A1 .. 1.95	5A1 .. 3.69	429A .. 6.95	876 .. 12.95	9058 .. 2.95	1A85/25S .. 1.85	6AL5 .. 1.25	7B4 .. 1.10	28D7 .. .98
2A1 .. 1.95	5A1 .. 3.69	430A .. 6.95	877 .. 12.95	9059 .. 2.95	1A85/25S .. 1.85	6AL5 .. 1.25	7B4 .. 1.10	28D7 .. .98
2A1 .. 1.95	5A1 .. 3.69	431A .. 6.95	878 .. 12.95	9060 .. 2.95	1A85/25S .. 1.85	6AL5 .. 1.25	7B4 .. 1.10	28D7 .. .98
2A1 .. 1.95	5A1 .. 3.69	432A .. 6.95	879 .. 12.95	9061 .. 2.95	1A85/25S .. 1.85	6AL5 .. 1.25	7B4 .. 1.10	28D7 .. .98
2A1 .. 1.95	5A1 .. 3.69	433A .. 6.95	880 .. 12.95	9062 .. 2.95	1A85/25S .. 1.85	6AL5 .. 1.25	7B4 .. 1.10	28D7 .. .98
2A1 .. 1.95	5A1 .. 3.69	434A .. 6.95	881 .. 12.95	9063 .. 2.95	1A85/25S .. 1.85	6AL5 .. 1.25	7B4 .. 1.10	28D7 .. .98
2A1 .. 1.95	5A1 .. 3.69	435A .. 6.95	882 .. 12.95	9064 .. 2.95	1A85/25S .. 1.85	6AL5 .. 1.25	7B4 .. 1.10	28D7 .. .98
2A1 .. 1.95	5A1 .. 3.69	436A .. 6.95	883 .. 12.95	9065 .. 2.95	1A85/25S .. 1.85	6AL5 .. 1.25	7B4 .. 1.10	28D7 .. .98
2A1 .. 1.95	5A1 .. 3.69	437A .. 6.95	884 .. 12.95	9066 .. 2.95	1A85/25S .. 1.85	6AL5 .. 1.25	7B4 .. 1.10	28D7 .. .98
2A1 .. 1.95	5A1 .. 3.69	438A .. 6.95	885 .. 12.95	9067 .. 2.95	1A85/25S .. 1.85	6AL5 .. 1.25	7B4 .. 1.10	28D7 .. .98
2A1 .. 1.95	5A1 .. 3.69	439A .. 6.95	886 .. 12.95	9068 .. 2.95	1A85/25S .. 1.85	6AL5 .. 1.25	7B4 .. 1.10	28D7 .. .98
2A1 .. 1.95	5A1 .. 3.69	440A .. 6.95	887 .. 12.95	9069 .. 2.95	1A85/25S .. 1.85	6AL5 .. 1.25	7B4 .. 1.10	28D7 .. .98
2A1 .. 1.95	5A1 .. 3.69	441A .. 6.95	888 .. 12.95	9070 .. 2.95	1A85/25S .. 1.85	6AL5 .. 1.25	7B4 .. 1.10	28D7 .. .98
2A1 .. 1.95	5A1 .. 3.69	442A .. 6.95	889 .. 12.95	9071 .. 2.95	1A85/25S .. 1.85	6AL5 .. 1.25	7B4 .. 1.10	28D7 .. .98
2A1 .. 1.95	5A1 .. 3.69	443A .. 6.95	890 .. 12.95	9072 .. 2.95	1A85/25S .. 1.85	6AL5 .. 1.25	7B4 .. 1.10	28D7 .. .98
2A1 .. 1.95	5A1 .. 3.69	444A .. 6.95	891 .. 12.95	9073 .. 2.95	1A85/25S .. 1.85	6AL5 .. 1.25	7B4 .. 1.10	28D7 .. .98
2A1 .. 1.95	5A1 .. 3.69	445A .. 6.95	892 .. 12.95	9074 .. 2.95	1A85/25S .. 1.85	6AL5 .. 1.25	7B4 .. 1.10	28D7 .. .98
2A1 .. 1.95	5A1 .. 3.69	446A .. 6.95	893 .. 12.95	9075 .. 2.95	1A85/25S .. 1.85	6AL5 .. 1.25	7B4 .. 1.10	28D7 .. .98
2A1 .. 1.95	5A1 .. 3.69	447A .. 6.95	894 .. 12.95	9076 .. 2.95	1A85/25S .. 1.85	6AL5 .. 1.25	7B4 .. 1.10	28D7 .. .98
2A1 .. 1.95	5A1 .. 3.69	448A .. 6.95	895 .. 12.95	9077 .. 2.95	1A85/25S .. 1.85	6AL5 .. 1.25	7B4 .. 1.10	28D7 .. .98

WANTED! WANTED!

ATTENTION colleges, schools, hams, industrials!! Highest prices paid for surplus equipment, parts, and tubes. We are especially looking for test equipment TS-12, 13, 35, 14/AP, 15/AP, 146/UP, 173, 174, 175, 239, 259, 263. Any types with TS prefix. Write, wire or call.



WANTED! WANTED!

APR-4, 5, 7 and tuning units. ARC-1, 3, ART-13, ATC, APS-10, microwave equipment in S, K, X-band. APS-15, APQ-13, APS-13, SCR-300, 284, 694, etc. BC-221, 342, 348. BC-1016 tape recorders. Write, wire or call.

RADAR—COMMUNICATIONS AND TEST EQUIPMENT

TS-35/AP X-band Signal Generator. Pulsed and C.W. freq. range. 8400-9600 mcs. This unit will measure power and frequency. 115v 60-2600 cye.

TS-3/AP S-band Frequency and Power Meter. Portable. Battery operated. Complete with all cables.

TS-33/AP X-band Frequency Meter. 8500-9600 mcs. Contains crystal detector and indicating meter. Output to scope will indicate pulse wave shape.

TS-62/AP X-band Echo Box. 8400-9600 mcs. tuned and untuned input. Will indicate resonance on meter. Complete with pick up antenna and cable.

TS-268/UP Crystal Diode Test Set. Used to check 1N21, 1N22, 1N23, etc. Battery operated. Portable. Complete with spares.

TS-89/AP Voltage Divider. 1:10 and 1:100 ratios. Wide band for true pulse shape. Output to scope.

TS-10/APN Altimeter Test Set. Good condition. Complete with cables and dummy antenna. \$35.00

TS-12 AP V.S.W.R. Test Set for X-band. Complete with amplifier, slotted line, termination, adaptors, etc. In 2 carrying cases. Excellent.

TS-23/APN Test Set to check freq. and power output of SCR-718 transmitter. Complete with all cables.

TS-36/AP X-band Power Meter. Consists of power measuring circuit, Horn antenna, co-ax to wave guide adaptor, connecting cable and probe. Will measure either absolute or relative power. Nominal band of usefulness is approx. 8.5-9.7 KMC. Excellent condition.

TS-118/AP R.F. Wattmeter for the range of 20-750 mcs. Will measure power up to 500 watts. Complete.

TS-174/U Freq. Meter. Freq. range is 50-250 mcs. High freq. version of BC-221. Excellent Condition.

1-185 Signal Generator. L-band search, S-band track. Used with SCR-515 and similar sets. Complete with cables. Good condition.

TS-61/AP S-band Echo Box. Using meter provided it is possible to maximize the XMITR adjustment and determine relative power output. Complete with probe and cable. Very good condition.

TS-131/AP Field Strength Meter. Consists of pickup unit, control box C-111/AP, cord CX-149/AP, adaptor M-359 and case. Unit will check output in range 200-1000 mcs. Excellent condition.

TS-226/AP used to measure peak power output of any xmitter in the range of 200-1000 mcs. Has provision for oscilloscopic signal observation and built in calibration. Part of AN/APM-29. Excellent.

TS-108/AP X-band Dummy Load. Consists of a length of X-band guide filled with sand. One end closed other terminates in a coupling choke. Excellent.

TS-14/AP consists of S-band signal generator, freq. meter, wattmeter and cables. Power input is 115v 50-2600 cye. Used to check various S-band radars and beacons.

TS-170/ARN-5 XTAL controlled test osc. with the following freq. ranges: 332.6, 333.8, 335.0 depending on XTAL in use. This set is used to align glide path receivers. Batteries and antenna are self contained. Excellent condition.

AN/APS-3 Airborne X-band Search and Homing radar. Complete. Contains RF head, modulator, synchronizer, control boxes, plugs, antenna, etc. 115v 400 cye. Excellent condition. \$875.00

ASB-5 L-band Search and Homing radar. Complete. Contains xmitter, receiver, power unit, control box, plugs, etc. 115v 400 cye. Excellent condition. \$125.00

SCR-518 Radar Altimeter. 500 mcs. equipment. Complete with xmitter, receiver, control box, power unit, junction box with all cables, racks, etc. Unit will indicate altitude up to 50,000 ft. Power input is 28v. New condition. \$125.00

AN/APS-15 R.F. Head and Modulator. X-band. Complete with all tubes. Good condition. \$125.00

AN/APA-23 Automatic Signal Strength and Time Recorder. Unit will scan a receiver thru its range and record all signals on electro-sensitive paper. Input is 115v 60-2600 cye. and 28v DC. Excellent condition. \$175.00

AN/CRT-3 Victory Girl. Dual frequency emergency lifeboat xmitter. Complete with xmitter, kite hydrogen generator, etc. New in knapsack. C.A.A. approved. \$129.50

AN/APR-5 Radar Search Receiver. Freq. range 1000-3100 mcs. Will detect signals up to 10,000 mcs. with reduced sensitivity. Contains oscillator and mixer cavity, IF strip, power supply. Input 60-2600 cye. 115v. Excellent condition. \$375.00

T-50 Radiotelegraph Transmitter complete with power supply and all accessories with spares. Portable. New in cases. \$375.00

AN/APT-5 300-1500 mcs. xmitter cavity oscillator using 3C22 lighthouse tube. Power output 30 watts. Noise modulated. Excellent condition. Complete with all tubes. \$149.50

SK-1M Radar Receiver Indicators. Freq. 195 mcs. 2 R.F. stages, 3 IF stages. 1 video, etc. New condition. \$125.00

SCR-183 Airborne Command Equipment. Freq. range 201-398KC and 2500-7700KCS. Complete. Contains receiver, xmitter, dynamotor, antenna switch, control box, coils, etc. Power input 21-28v. Brand new in original cases. Manufactured by Western Electric. \$125.00

NAVY RU Command Equipment. Similar to SCR-183. \$125.00

DU-1 Direction Finding Equipment for SCR-183 and RU Series Equipment. Can be used with any receiver for direction finding in freq. range 200-1000KC. New. Complete. \$45.00

SCR-515 (BC-845) contains xmitter, receiver, dynamotor PE-101, control box, manual, etc. New. \$18.95

AN/PPN-1 EUREKA! Ground portable, beacon responder. Unit will work into the AN/APN-2 transponder for purposes of homing. C.W. communication can also be carried on between plane and ground. Unit comes complete with xmitter, receiver, power pack, phones, etc. Brand new in knapsack. AN/APN-2 EQUIPMENT CAN BE SUPPLIED ON ORDER.

SCR-269/G Automatic Radio Compass. Freq. range 200-1750KC. Complete with BC-433-G receiver. BC-434, LP-21, 1-81, 1-82, BK22, etc. Very good condition. \$129.95

SCR-300 Frequency Modulated Transceiver. Freq. range 40-48 mcs. complete with 18 tubes, handset and antenna. Powered from self contained battery pack. Excellent condition. Weight approx. 35 lbs. with battery, each. \$450.00 Pair. \$800.00

TCS Marine Radio Telephone and Telegraph Mxting and Receiving Equipment. Freq. range 1500-12000KC. Consists of xmitter, receiver, antenna loading coil, remote control box, power unit, cables, etc. Power input is 12 or 32v DC. We can supply an 110v AC power supply for stationary use at additional cost. Excellent condition.

SCR-536 Xmitter-Receiver (handy talkie). Freq. range 3885-5500KC. Complete with coils, tubes, crystals. Very good condition. \$69.95

AN/APA-10 Panoramic Adaptor for use with any receiver with following IFs: 455KC, 5 mcs. 30 mcs. Unit will give panoramic presentation (1 mc wide for 455KC input) (100KC for 5MC input) (2MC for 30 mcs input). Power input 115v 400 cye. but can be changed with the addition of a proper power transformer. Excellent condition. \$175.00

AN/ARN-5 Glide Path Receiver. Freq. range 332.6, 333.8, 335.0 mcs. selected by changing crystals. Complete with receiver, mounting MT-28, AS-27 antenna, BC-732 control box, and indicator 1-101-C. Power input is 28v 1.7 amp. Excellent condition. \$49.95 With B model receiver. \$99.95

SCR-510 Freq. Modulated Portable Transceiver. Covering range of 20.0-27.9 mcs in 80 channels 100KC apart. Complete equipment consisting of BC-620 transceiver, power supply PE-97A, T-17 mike, handset, AN-45 antenna, battery operated or 6 or 12v input. Excellent condition. \$69.95

SCR-610 similar to SCR-510 except for freq. range which is 27.0-38.9 mcs. Excellent condition. \$79.95

AN/APA-11 Pulse Analyzer to work with Search Receiver for analysis of received pulsed signals. PPS, pulse width, wave shape, can be displayed on an CR tube. Unit can also be used as a standard oscilloscope for general servicing work. Input is 115v-400-2600 cye. but can be changed with the addition of a 60 cye. transformer. Very good condition.

SCR-694 Field Radio. Light weight version of SCR-284. Freq. range is 3.8-6.5 mcs. Power output is AL-20, A3-51 comes with transceiver BC-1306, GN-15 or 53 hand generator, antenna system, microphone, headset, etc. In excellent condition.

PE-237 AC Power Supply for stationary use can be supplied at additional cost.

SCR-522 VHF Airborne Command Equipment. Freq. range 100-156 mcs. in 4 channels receiver and transmitter. Crystal controlled. Complete equipment. Consists of trans/rec, control box BC-602, dynamotor PE-94, AN104A antenna, plugs, etc. Power input with PE-94 is 28v. Excellent condition. We can supply PE-98 dynamotor for 12v input at additional cost.

COMMAND EQUIPMENT

ARC-5 274N OTHERS RECEIVERS

ARA 500-1500KC. New. \$24.95
 453B 200-550KC. New. 14.95
 455B 6-9 mcs. New. 16.50
 433 200-1750KC. Good. 29.95
 ARR-2 231-258 mcs. New. 19.95

TRANSMITTERS

459-A 7-9.1 mcs. New. \$12.85
 696-A 3-4 mcs. New. 29.95
 TYPE O 5-3.7 mcs. New. 9.95
 AVT-23 3000-13,000KC complete w/control box manual, etc. C.W. or phone. 11 or 28v input. Brand new. Original cases. 79.50
 BC-950A 100-166 mcs. New. 59.95

ACCESSORIES

BC-456 Modulator. Good. \$2.25
 BC-450 Control Box (3 rec). Used. 1.25
 BC-451 Control Box (xmitter). Used. .98
 BC-442 Relay Unit (ANT.). Used. 1.95
 Flexible Shafting Available

MISCELLANEOUS SPECIALS!

Sound Powered Chest and Headsets MI-2154-B type O, mfr. RCA. Brand new in original boxes. Pair. \$ 29.95
 Trailing Wire Antenna Feed Tube. New. 5.95
 Goniometer for SCR-277 Direction Finder. Excellent. 39.95
 RL-7 Interphone Control Box. New. 1.95
 FT-154 BC-2148 Shock Mounts. 2.98
 AN/CRW Receiver for Remote Control. 5.95
 BC-1206 Beacon Receiver 200-400KC, 28v in. Excellent. 4.95
 MN/26-V Compass Receiver. Very good. 24.95
 BC-433G Compass Receiver. 200-1750KC in 3 bags. Excellent. 39.95
 RC-778 Gibson Girl 500KC. Good condition. 3.95
 BC-1016 Tape Recorder. Complete. New. 459.50
 CH Unit with 200KC Xtal. New. 14.95
 T-17 Carbon Mike. Used. Good. 1.59
 BC-329 Transmitter. Excellent. 89.95
 QBC-1 Sonar complete with Hydrophone. Excellent. 125.00
 BC-1091 RF Head. Very good condition. 69.95
 AN/104A Antenna for SCR-522, ax handle. New. 3.95
 LP-21 Direction Finding Antenna. Good. 12.95
 ASB 500 mcs YAGI Antenna Dual 6 Element Single 5 Element. 8.95
 AN/APA-17 Radar Direction Finding Antenna, back to back parabola, freq. range 300-1000 mcs. Horizontally and vertically polarized. Excellent. 59.00
 CG- (172/173) CPN-8 10CM Coax Patch Cable. New. 4.95
 CX-548/CRD-3 Cable. New. 1.25
 CX-516/CRD-3 Cable. New. 1.25
 CD-508A with SW 14-U and 2 Cord Attachments with JK-48 Jack and PL-68 Plug. New. .75
 CD-307A with PL-55 and JK. New. 1.29
 Spares for ARC-5 and 274/N, APX-1, ASG-10. We have a large stock of TS-34A/AP Spares.

COAXIAL CABLE CONNECTORS

83-1AP	\$.30	83-1SP	\$.45	83-168	\$.15
83-1F	1.30	83-1SPN	.50	83-185	.15
83-1H	.09	83-1T	1.30	UG-27-U	.68
83-1J	.80	83-22AP	1.10	UG-58-U	.63
83-1R	.40	83-22R	.48	UG-83-U	.88

Others in stock. Write for prices.

CORDS AND PLUGS

CD 508A Cord Assembly with SW 14-U Switch and 2 cord attachments with JK 48 Jack and PL 68 Plug. Value—\$5.00. Our Special Low Price. Brand New. 59c

CD307A with PL 55 and JK. New. \$1.29

JK 26 Jack only—Brand New. 20c

PL 55 Plug—New. 35c

PL 68 Plug—New. 25c

Jones plug 8 contact male and female

PL-Q-69 49c

PL-P-60 49c

PL-Q-61 49c

PL-Q-62 49c

PL-Q-77 69c

PL-Q-171 89c

PL-153-A 69c

PL-172 89c

BC-221 FREQUENCY METER

This is a Terrific Value! QUANTITY IS LIMITED—so first come, first served. They are just like new, with original calibration charts. Range 125-20,000 KC with crystal check points in all ranges. **ONLY \$99.50** Complete with crystal and tubes.

DYNAMOTORS AND POWER UNITS

Type	Input Volts	Output Volts	Amps	Price
DM-19	12	500	.200	\$ 6.95
DM-25	12	250	.050	4.95
DM-32	28	250	.060	1.75
DM-33	28	570	.160	2.95
DM-34	12	220	.080	8.95
DY-12	12	275	.110	
		500	.50	
PE-73	28	1000	.350	10.00
PE-94	28	300	.260	
		150	.010	
		14.5	.5	2.25
PE-97	Vibrator	Power Supply		8.95
PE-98	12v	300v		35.00
PE-101	28	400	800	5.75
		500	.160	35.00
PE-103	6 & 12	500	.160	15.95
PP-18-AR	Vibrapak			29.95
RA-42	(for BC-639 Receiver)			
ATK	Inverter	110v AC	125 watts	14.95

PHONE DIGBY 9-0347

WRITE FOR QUANTITY PRICES Prices subject to change without notice. F.O.B., NYC. Minimum order \$10.00. 20% deposit required. All merchandise guaranteed.

RADIO HAM SHACK Inc.
 189 GREENWICH STREET . NEW YORK, N. Y.

SYNCHROS • AMPLIFIERS • ALNICO MOTORS • SHUNT MOTORS • BLOWERS • RATE GENERATORS • SUB-FRACTIONAL HORSEPOWER AC MOTORS • SELSYN

AUTOMATIC PILOT COMPONENTS • DC MOTORS • SINE-COSINE GENERATORS • U. S. NAVY SYNCHROS • AUTOSYNS • SERVO MOTORS • DYNAMOTORS

IMMEDIATE DELIVERY

Servo-Tek

FULLY GUARANTEED

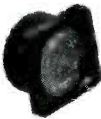

ANTENNA TILT INDICATOR

D-C Selsyn type tilt indicator. G.E. 8DJ29AAK. 24 volt. Stock #SA-296. Price \$3.75 each.



Gyro and Housing Mirror Assembly. For K-14A sighting head. Gyro stabilized mirror assembly. Stock #SA-294. Price \$6.75 each.

BODINE NSHG-12 MOTOR

Constant speed



27 v. D-C Governor controlled 3600 rpm. 1/30th hp. Stock #SA-39. Price \$17.50 each.



REVERE CAMERA MOTOR

27 v. D-C. Split field series. Approx. 2 1/2" sq. x 2 1/2" lg. Stock #SA-315. Price \$6.75 each.

SYNCHRONOUS MOTOR



W.E. S-1283228. For 2 phase 240 cycle operation. 55 volts.

Stock #SA-317.

Price \$9.75 each.



DC MOTOR

High speed 27 v motor with high inertia flywheel. Ideal for gyro demonstrations.

Stock #SA-S-313 Price \$9.75 each.

SWEEP GENERATOR CAPACITOR



Hi-speed bearings. Split-stator. Silver-plated coaxial type. 5-10 mmf.

Stock #SA-167

Price \$2.75 each

MINIATURE DC SELSYN

INDICATOR



G.E. miniature indicator. 24 v. d-c operation with G.E. Position Transmitter or with Ohmite 360° type potentiometer. Has iron

plug for zero dial adjustment. Stock #SA-248. Price \$14.50 each.

400 Cycle M G Set



1 hp 115/220 Volt 60 cycle motor belted to 700 VA 400 cycle 115 volt generator. Variable speed pulley for precise frequency adjustment.

Price \$189.50



Aircraft Generator Eclipse NEA-3

Output 115 VAC; 10.4 amps 800 cycles at 2400 rpm. Also 30 VDC at 6 amps. Stock #SA-306. Price \$49.50 each.



PRECISION AUTOSYN

Pioneer Type AY-150 Control Autosyn. Precision type. 26 v. 400 cycle. Stock #SA-297. Special low price \$14.50 each.



A-5 Autopilot Indicator

Autosyn Type Pilot Indicator for A-5 Autopilot. 26 v. 400 cycles. Stock #SA-299. Price \$12.50 each.

3/4 HP DC MOTOR

Electric Specialty Co. HCA315T. 24 volts DC. 3800 rpm. Stock #SA-321. Special Price \$24.50 each.

ARMA 5A MOTOR

10 Watt Servo Motor—2 phase 115 v. 60 cycles. 3 1/2" lg. x 3 1/2" diam. 1" shaft ext. 0.250 diam. one end, other ext. 3/8" lg. 0.250 diam. Stock #SA-231. Limited quantity. Price \$49.50 each.

400 CYCLE AIRCRAFT ACTUATORS

Manufactured by AirResearch. 115 volt 400 cycle operation. 2 1/2" linear travel. Stat. load 200 lbs. Ten. 75-100 lbs. Comp. 75-100 lbs. Stock #SA-326. Price \$24.50 each.

WINCO DYNAMOTOR

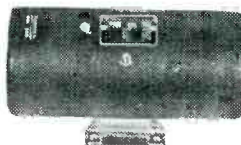

Model 41S6. 13 v D-C in. @ 13 A. Output 250 v @ 0.60 A and 300v @ 0.225 A. Stock #SA-323. Price \$9.50 ea.

MAGNETIC AMPLIFIER ASSEMBLY

Sperry 661824. Saturable reactor type output transformer. Designed to supply one phase of 400 cycle servo motor. Stock #SA-266. Price \$6.75 each.



Compass Indicator

I-82F Compass Indicator. 0-360°-5 in. dial. 26 v 400 cy. 8-12 v. 60 cy. Ideal position indicator. Stock #SA-284.

Price \$6.50 each

DC SERVO MOTOR



Elenco Type B-64. 1/165 hp at 3100 rpm. Field volts 27.5 Max. armature voltage 80. Ideal for thyatron servo control. Stock #SA-211. Price \$16.50 each



Pioneer Servo Motors

Type 10047-2A. 2φ 400 cycle low inertia. 26 v fixed phase. 45 v. max. variable phase. Stock #SA-90. Price \$12.50 each.



PIONEER CK-17

400 cycles 2 phase, 26 v fixed phase. 45 v. max. variable base. Built in gear reduction. Output shaft speed approx. 4 rpm. Stock #SA-287. Price \$16.50.

LOAD & BALANCE COMPUTER



C-54B Aircraft load computer. Totals load and locates center of gravity. Voltage divider type computer. Ideal for classroom. Stock #SA-234. Price \$49.50 each.

INVERTER



Pioneer 12130-4-B Input 28 VDC at 14 amps. Output 120 v. 400 cy. Single Phase at 1.15 amps. (140 VA.) Voltage and frequency regulated. Made 1949. Stock #SA-304. Price \$39.50 each.

MICROPOSITIONER

Barber Colman AYLZ-2183. Polarized dc relay. Double coil differential current sensitive. Alnico PM polarized field. 24 v. Contacts 0.5 amps 28 v. Use for remote positioning, synchronizing, control, etc. Sens. 1.25 ma. diff. Use to 100 cy. Stock #SA-290. Price \$12.50 each.



JA1 MOTOR (D-C)

Electric Specialty. 1/4 hp. 24 v. D-C. (Wing flap motor.) Stock #SA-325. Price \$19.50 ea.



Synchros - Selsyns

1SF, 1G, 5G, 5F, 6CT, 5HCT, 5SDG, 5DG, 5SG, 5SF, 5HSF, 6G, 6DG, 7G, 2J1F1, 2J1G1, 2J1H1, 2J5F1, 2J5R1, 2J1F3, XXI, X, XV, VII, II, IV, etc.

WRITE FOR LISTING

Prices F.O.B. Paterson
Phone ARmory 4-3366

Servo-Tek

products co.

4 Godwin Ave. Paterson, N. J.

SPECIALISTS IN FRACTIONAL HORSE POWER MOTOR SPEED CONTROL

RELAYS FOR EVERY PURPOSE

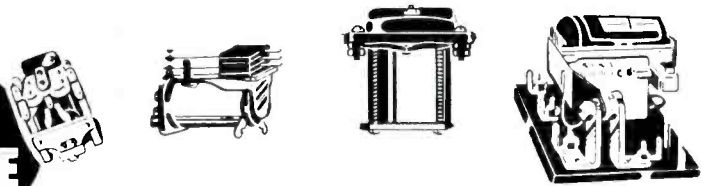

Over a Million in Stock!

Whether you require large quantities of relays for production runs or single units for laboratory or amateur work, Wells can make immediate delivery and save you a substantial part of the cost.

in the selection of correct types to suit your exact requirements.

Each relay is brand new, standard make, inspected, individually boxed and fully guaranteed.

Our capable engineering staff is prepared to offer assistance

The following list represents only a tiny portion of our relay stock. Write or wire us for information on types not shown.

STANDARD DC TELEPHONE RELAYS				
Stk. No.	DC Voltage	Ohmage	Contacts	Unit Price
R-806	115*	900	1A	\$2.05
R-161	6	10	2B & 1A	1.10
R-100	24	600	2A & 1C	2.45
R-289	40	3300	5A	2.20
R-518	85/125	6500	1C	3.60
R-266	150	6500	1A	2.45
R-633	180/350	10,000	1C & 5 Amps.	2.90
R-664	110	—	2B & 1A/Octal Socket	2.45
R-684	115	—	1C	2.45
R-264	220	—	1B & 3A	2.45
R-564	220	—	1B/10 Amps. 1A/3 Amps.	2.45
R-667	6	.75	1B/10 Amps. 1A/3 Amps.	1.45
R-632	6	12	5A & 1C	1.25
R-154	6/12	200	1A	1.50
R-517	12	250	2A	1.50
R-777	12/24	70	1A & 1B	1.50
R-578	24/48	2500	1B & 1A	1.30
R-118	85	3000	1B	3.05
R-583	110	3300	1A	2.20
R-631	100/125	3300	2A	1.90
R-827	150	6500	2A, 1B	2.45
R-623	150	6500	1C & 2A	2.45
R-571	150	7000	1B & 2B	2.45
R-565	150	7000	1C & 2B	2.45
R-545	110/250	7000	1C	2.45
R-124	300	12,000	1A	1.55
R-511	24	200	W/Micro N.O.	3.05
R-160	6	12	3C & 3A	1.30
R-591	6	40	1B & 1C	1.35
R-592	12	100	1B & 2C	1.35
R-155	12	100	4A & 4B	1.45
R-520	200/300	14,000	2C	3.45
R-159	6	50	2A	1.35
R-158	6	50	4A	1.35
R-576	12	200	2A	1.35
R-153	12	200	1C & 1A	1.55

SHORT TELEPHONE RELAYS				
Stk. No.	DC Voltage	Ohmage	Contacts	Unit Price
R-635	12	100	1C & 1A	1.35
R-648	12	170	1E	1.35
R-826	12	150	2C, 1B	1.55
R-770	24	150	1A/10 Amps.	1.45
R-538	24	180	2A	1.55
R-771	24	200	1A/10 Amps.	1.45
R-603	18/24	400	2A	1.55
R-575	18	500	2C	2.40
R-764	48	1000	2C & 2A	1.85
R-563	60/120	7500	1A	1.70
R-801	115*	—	None	1.45
R-213	5/8*	—	2A	3.10
R-690	115*	—	2C	2.45
R-539	12	125	2A	1.30
R-133	12	150	4A	1.55
R-689	12/24	255	1C	1.55
R-799	24	500	None	1.00
R-114	24	500	4A	1.60
R-115	24	500	1C	1.70
R-110	24/32	3500	1C	1.70
R-121	150	5000	2A & 1C	2.05
R-634	150/250	6000	1A & 1B	2.45
R-800	12	150	2C & 1A	1.55
R-537	12/24	150	2C & 1B	1.55
R-750	24	400	1A	1.60

SLOW ACTING				
Stk. No.	DC Voltage	Ohmage	Contacts	Unit Price
R-547	24	200	1C—Slow Break	\$1.80
R-548	48	1000	1B—Slow Make	2.00
R-128	50	2100	1C—Slow Break	2.80
R-525	12/24	200	1C/10 Amps. S. Mk.	1.55
R-794	12	3 Coils.	16 Ohms ea. 3B & 3A/15 Amps. S. Mk.	3.35

CONTACTORS				
Stk. No.	DC Voltage	Ohmage	Contacts	Unit Price
R-188	24	200	1A/75 Amps.	\$3.70
R-183	24	60	1A/50 Amps.	3.45
R-187	24	100	1A/50 Amps.	3.70
R-554	24	85	2A/100 Amps.	5.90
R-788	100*	—	3B & 2A	5.45
R-682	115*	35	5A/10 Amps.	6.10
R-767	24*	20	2A/10 Amps.	3.70
R-180	12	25	1A/50 Amps.	4.05
R-657	24	50	4A/100 Amps.	6.95
R-265	24	60	1A/100 Amps.	3.45
R-535	24	70	1A/100 Amps.	4.80
R-556	24	70	1A/100 Amps.	4.80
R-557	24	100	1A/50 Amps.	3.85
R-178	24	100	1A/100 Amps.	4.80
R-727	10	20	1A/200 Amps.	1.85
R-608	24	125	1A/200 Amps.	2.80
R-184	28	50	1A/100 Amps.	4.90
R-719	24	10	1A/200 Amps.	4.90
R-182	28	80	1A/25 Amps.	2.40
R-244	75*	265	1A/20 Amps.	2.20
R-659	12	7.2	2A/20 Amps.	1.70
R-681	12/15	16	2A/15 Amps.	1.55
R-562	24	70	4A/50 Amps.	5.35
R-185	24	100	1A/50 Amps.	3.45
R-186	24	132	1A/50 Amps.	4.35
R-817	24	150	1A/50 Amps.	3.45
R-534	14	45	1A/30 Amps.	2.05
R-223	28	150	1A/40 Amps./48 VDC.	1.70
R-680	6	3	1A/50 Amps.	3.90
R-677	6	3.5	1A/50 Amps.	3.90
R-532	6	15	1A/50 Amps.	3.90
R-676	12	16	1A/25 Amps.	3.05
R-678	12	18	1 Aux/25A	3.90
R-656	12	100	1A/50 Amps.	3.90
R-553	24	55	1A/5 Amps.	4.05
R-679	24	80	1A/50 Amps.	3.90
R-610	24	80	1A Double Break	2.05
R-555	24	100	1A/50 Amps.	4.80
R-533	24	150	1A/50 Amps.	4.05
R-717	24	200	1A/100 Amps.	3.45
R-703	12	20	2A/25 Amps.	2.80
R-748	24	60	1A/30 Amps.	2.45
R-655	24	80	1A/50 Amps.	6.05
R-654	24	150	2A/40 Amps.	2.40
R-742	24	7	1A/25 Amps.	3.05

ROTARY RELAYS				
Stk. No.	DC Voltage	Ohmage	Contacts	Unit Price
R-709	6/8	1	12 Pos. 3 Water	\$3.90
R-197	9/16	70	2C	1.45
R-713	9/14	125	1C & 1A	2.05
R-198	9/14	125	3B, 3A, 1C	2.05
R-616	28	7	5B & 1A	1.90
R-712	24	200	2B	2.05
R-711	24	200	2C & 1B	2.05
R-573	20	10	1C & 1B	2.05
R-284	28	200	4C & 1B	1.45
R-200	24/32	275	3C & 1B	2.05
R-766	24	230	12 Pos. 8 Deck.	4.90
R-809	28	7	1B & 12 Pos. W/7" Shaft for Wafers.	2.45

W-E- TYPE "E" RELAYS				
Stk. No.	DC Voltage	Ohmage	Contacts	Unit Price
R-736	18/24	600	3C	\$1.50
R-585	12	650	2C	1.30
R-287	12/24	650	2C	1.30
R-164	24/32	1000	1A	1.50
R-646	24/48	1300	1B	1.50

DIFFERENTIAL RELAYS				
Stk. No.	DC Voltage	Ohmage	Contacts	Unit Price
R-208	120	2000	2C/3 Amps.	\$2.45
R-209	220/250	8000	1C/3 Amps.	3.10

SEALED RELAYS				
Stk. No.	DC Voltage	Ohmage	Contacts	Unit Price
R-658	6	35	2C/Octal Plug	\$3.45
R-125	24	300	2C/Octal Plug	3.45
R-261	12/24	1900	1C/5 Pin Plug	3.75
R-673	48/150	7500	1C/5 Amps.	2.80

VOLTAGE REGULATORS				
Stk. No.	DC Voltage	Ohmage	Contacts	Unit Price
R-745	6	2	1A/10 Amps.	\$1.05
R-780	24	350	1C/6 Amps.	1.05
R-509	6/12	35	1B/2 Amps.	1.05

SPECIAL RELAYS				
Stk. No.	DC Voltage	Ohmage	Contacts	Unit Price
R-503	12/32	100	3A, 2C	\$2.80
R-749	600	—	Max. 28 Amps.	7.45
R-804	550*	—	1B/38 Amps.	4.35
R-250	115*	—	Adj. Cir. Bk.-04-16A	17.50
R-579	220*	—	1B	8.70
R-294	27.5	200	1B	5.35
R-686	115*	—	2C	6.10
R-246	115*	—	1B	11.20
R-246A	115*	—	1A	11.20
R-611	24*	—	1A/30 Amps.	5.35
R-283	12	125	1C/10 Amps.	1.25
R-614	12/24	60	1A/15 Amps.	4.35
R-262	—	200	1C	4.70
R-245	12	25	4" Micalox Lever	1.20
R-527	6/12	50/50	In Series	1.20
R-544	12/24	60/60	1C	2.05
R-255	—	—	1A	1.20
R-669	75*	400 Cy.	1B, 1A	1.20
R-660	6	—	3/8" Stroke	1.20
R-651	24	100	Solenoid Valve	3.10
R-295	12	275	Annunciator Drop	2.70
R-230	5/8	2	2A, 1C	2.70
R-813	12	12	Wafer	5.35
R-275	12	750	1A, 1B, 1C	3.45
R-716	24	70	2A/5 Amps.	1.80
R-620	6/12	35	2C, 1A	1.30
R-629	9/14	40	1C/10 Amps.	1.55
R-720	24	50	2C, Ceramic	1.70
R-500	12	10/10	2C/6 Amps.	3.55
R-816	12	10/15	2C/6 Amps.	3.55
R-624	24	—	2C/6 Amps.	1.20
R-566	115*	—	Coil Only	1.60
R-710	150	—	Coil Only	1.60
R-710	—	—	† AC/DC	1.75

SPECIAL!

CO-AXIAL RELAY

D153766 SPDT, 6 VDC. 19 OHM Coil. Designed to accommodate 75 watts maximum. Perfect for all types of antenna switching. Designed for using standard 83-1SP coaxial fittings. Part of RAX-1 equipment. No. R-845 \$6.95 ea.

BASIC CONTACT ASSEMBLIES SHOWN IN UNOPERATED NORMAL POSITION

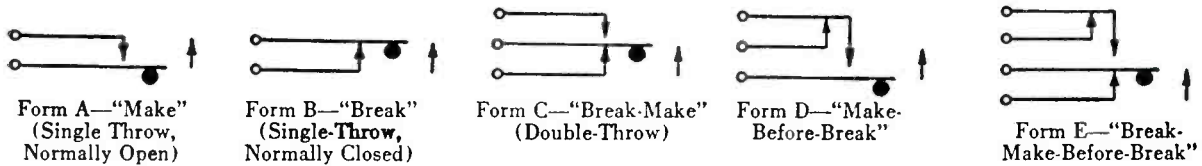

WRITE FOR WELLS CATALOG

TELEPHONE SEley 8-4143



833 W. CHICAGO AVE., DEPT. SL, CHICAGO 22, ILL.

E88 TELEPHONE PARTS
LARGE QUANTITY
COILS, BLOCKS, COILS
ARC/5 SPARES & PARTS

- 2830 KC IF's for 6-9 Rec. (3 coils, imp. int. out) per set. \$1.25
 #6234 6-9 RP. 3 ea. .65
 5856 2830 KC BFO coil 6-9 Rec. .49
 5414 Cond. 3 x .05 300V. .05
 5415 Cond. .05-.01-05 300V. .10
 6261 Xrmr. Mike to Grd. v. .79
 6262 Osc. coil. .79
 6030 Osc. coil. .79
 6032 Osc. coil. .79
 7247 coil Pa. .79
 Parasitic Suppressors .05
 Plug 6 pin for IF. .10
 Plug 7 pin for Rec. chassis. .10
 Plug 3 png. rec. dyn. male .15
 female .15
 Plug 3 png. mod dyn. female. .15
 #7023 5 png chassis mnt. .25
 #5842 plug rear Rec. & Xmt. male .39
 5577 Plug 5 png chassis Rec. mnt. .29
 6415 Plug 8 png chassis Rec. Mnt. .29
 7027 plug 18 pin mod. chassis. .29
 PL 154A 12 png. male. .49
 PL 153A 18 png. male. .49
 PL 148 3 png. male. .49
 PL 156A 5 png. male. .49
 #2674 3 png. plug for HF Rack .29
 Rec. plates 180-550 KC. .10
 Control Box plates 190-550. .10
 #6085 Loading coil. .59
 #6034 Loading coil. .59
 #7902 Loading coil. .59
 Dual Fuse mnts. .10
 Xtals for Xmttrs Tube Type. 1.00
 Tubes: 1626 1029 1625

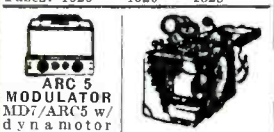

ARC 5
 MODULATOR
 w/ARC5 w/ dyna motor complete w/ Tubes 1-1215. 2-1625. 1-UR 50. Good cond. Price . \$6.95

SCR274
 Screen Mod. X F R M R for pair of 807's PP - PP - PP Parll Sidetone Wndg. .95c

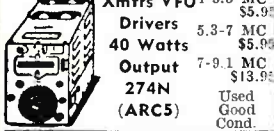

Xmfrs VFO 4-5.3 MC
 Drivers 5.3-7 MC
 40 Watts \$5.99
 Output 7-9.1 MC
 274N \$13.95
 (ARCS) Used Good Cond.

NEW TEST EQUIPMENT

- Frequency Modulated Generator Type 155A Frequency 38 MC-56 MC. Range 1 MC-10 MC. Boonton Radio.
 Solar Examer Capacitor Analyzer Tube Tester Model 7050. Philco 110. 120 AC 60 Cy.
 3" scope No. 155A C. R. Oscilloscope R. C. A.
 Test Set I-180A. Hickock Model 541 Test Equipment Tube checker.
 Sweep Signal Generator Model 909 McMurdo (Silver). Range 2-228 MC. Output 0-.5 V Max. 105/125V 50/60 Cy. 3 W.
 Frequency Meter BC221N 125-20000 KC.
 Precision Series E-400. Sweep Generator FM-TV-AM.
 Signal Generator Model 702. Radio City Product.
 Standard Signal Generator Model 78B. Boonton (Measurement Corp.)
 Television Calibrator WR-39A. R. C. A.
 Microvibrator Model 20-B Ferris Instrument Boonton.
 Signal Generator I-216 15-26 MC. CKE 115V/60 Cy. 180-235 MC.
 Model LU-1. Itardar Test Equipment. Frequency meter & Test Oscillator.
 Industrial Instrument Bridge. LR2 DRI. 10 Watt 115V 60 Cy.
 Industrial Instrument Bridge RN-1 Hunter charging control analyzer Model 372K.
 Hickock Thermo Ammeter Model 14T #1-4270.
 Weston DC Milliammeter Model #155 Leads & North Type S Test Set #5300 #5410.
 R.C.A. Voltmeter Ohmyst.
 Leeds North Galvanometer #2420A.
 GR Output Meter #783A.
 Boonton Q Meter Type 160A & 170A Industrial Bridge L14D.
 Write or Phone for Price

VARIABLE CERAMICONS

305-475 MMF. .20c
170-315 MMF. .20c
12-195 MMF. .20c
12-145 MMF. .20c
15-160 MMF. .20c
5-80 MMF. .20c
Set of 6 for. \$1.00

MODULATION XFMR'S

#T104 P-P GL6's to 832 RE. 20W. . \$1.49
 #5651 Screen Mod. 807 to 807 or Ten. 807: Sidetone Wdg. . .95c

METER SPECIALS

AMPS-RF
 0-4 Amp RF GE Type DW52. 2% Accuracy. Expanded Scale. 1.37" dia. Int. Thermocouple. List Price \$19.75. Our Price. \$2.95

CRYSTALS Low Frequency

FT-241. A holder 1/2" pin spacing. for ham and general use. Xtal controlled Signal Generators, marked in army Mc harmonic frequencies-Directions for deriving fundamental frequencies enclosed. Listed below by fundamental frequency. Fractions omitted.

AVAILABLE IN STOCK LARGE QTY.
RC 375 or SCR 191 PARTS
AND EQUIPMENT PHONE-WRITE

INVERTER PE 218
 IN: 28VDC 92A. Out: 115V. 500 cy. 1500 VA.
 NEW \$49.50
 USED, EX \$35.00

SELSYN MOTORS
 115VAC 60 cy #C78243. Can be used to turn Ant. Small Ind. Also Differential C-78249 3 1/2"x5 1/2". Set of both. \$15.95 pr.

BATHTUB CAPACITORS

MFD	Volt	Type	Price Each 10 for
.5	400	2BT	\$0.23 \$2.20
.5	600	2TT	.25 2.40
3x.1	600	3TT	.45 4.35
3x.1	600	3ST	.45 4.35
2x.1	400	3ST	.26 2.50
2x.1	600	3ST	.28 2.65
2x.1	600	3BT	.28 2.65
2x.1	400	2TT	.26 2.50
2x.1	200	2ST	.23 2.20
2x.1	600	2BT	.26 2.50
2x.1	600	2ST	.26 2.50
1-1-			
.025	400	3ST	.28 2.65
.1	600	2BT	.22 2.10
.1	600	1ST	.22 2.10
.1	600	2TT	.22 2.10
.1	600	2ST	.22 2.10
.13	600	2ST	.22 2.10
2x.25	600	3ST	.30 2.85
.05	600	2TT	.21 2.00
1	100	2TT	.23 2.20
20	50	2ST	.26 2.50

THERMISTORS

D-166288. . \$1.50
 D-168292. \$1.75
 D-167332 (tube). \$1.50
 D-170396 (head). \$1.50
 D-167113 (button). \$1.50
 D-164699 for WTC. \$1.65
 "X" band Guide \$2.50

MOBILES! C.A.P. C.D.I!
 6 V. DYNAMOTOR SUPPLY RATINGS
 OUTPUT INPUT
 Volts450 VDC 6 VDC
 Amps350 MA 450 MA
 OR
 Volts450 VDC 6 VDC
 Amps200 MA 225 MA
 Originally designed for 14V. but mobiles over U.S.A. report ex. results on 6V.
 Brand New, w/Filter Box, Starting Relay.
 Mounting Plate. \$12.95
 Plugs, Set of 2. \$1.00
 (With Dynamotor only)

VARIATORS

D-167176 \$.95
D-172155 \$2.25
D-172307 \$1.75
D-172108E \$1.85
D-172155 \$1.65
D-168687 \$.95
D-171812 \$.95
D-207528 \$.95
D-165593 \$1.25
D-162356(308A) . . . \$1.50

BC605 Interphone Amplifier
 Easily converted to an ideal inter-communications set for office-home-or factory.
 Brand New \$4.75

VARIABLE TRIMMER CONDENSERS

C890 15 MMF } 32c ea.
C881 20 MMF }
C993 50 MMF }
C677 60 MMF }

370	424	472	505	537
372	425	473	506	390
374	426	474	507	391
375	427	475	508	392
376	429	476	509	393
377	430	477	511	394
379	431	479	512	395
380	433	480	513	396
381	434	481	514	397
383	435	483	515	398
384	436	484	516	400
385	437	485	518	401
386	438	486	519	402
387	440	487	520	403
388	441	488	522	404
412	442	490	523	405
413	443	491	525	406
414	444	492	526	407
415	445	493	527	408
416	458	494	529	409
418	459	495	530	411
419	460	496	531	
420	462	497	533	
422	469	503	534	
423	470	504	536	

each \$1.49
 59c

932 PHOTO TUBE
 Gas Photo-tube having S1 response, particularly sensitive to Red and Near Infrared Radiation. Can be used with incandescent light source. Send for Data Price 75c
 400 MA 12 HY Choke \$3.75
 90 ohms Herm sealed. Special Price \$3.75

NEW!! Electrolytic Capacitors Condensers

20	50	.15
20	50	.18
20	350	.30
24	350	.30
25	25	.10
30	300	.25
30	450	.30
40	150	.22
40	450	.40
50	25	.22
50	50	.25
50	150	.39
50	250	.40
250	15	.50
500	8	.60
500	25	.75
1000	6	1.20
2000	6	1.35
1200	1	1.10
8-8	450	.60
8-16	450	.65
10-10	150	.30
10-10	450	.35
16-16	450	.70
20-20	150	.40
20-20	450	.50
40-20	150	.55
50-50	150	.40
50-30	150	.35
70-70	175	.85

DO Plug in Type C

2 x 20/2525
2 x 10/45040
16/45035
16/60045
10/45035
3/45025
8/60045
3 x 10/45040
10-10/20/45035
2 x 160/15025
2 x 80/5025
100-10/125035
3 x 100/2535
2 x 40/15035
80/45045
30/45040
50/10025

DT Pigtail Type J

100/25 \$.08
10/2508
16/45008
8/30015
8/5015
2/2508
4/5008
8/15010
4/15010
12/45015
10/15010

DHS Leads Paper Type J

8-8/45040
8-16/45045
50-30/25040

DI Screw Lug Type B

2 x 20/450 \$.60
2 x 10/45050
16-8/45060
20-51/45050
10/45050
8-8/45060
25/2525
24/47530
40/45040
2 x 24/40050
50/5030

D Screw Leads Type B

12/250 \$.40
40/25040
8/25040
8/45045
2 x 8/45055
4/60060
8/60050
24/25050
20/45055
24/25040
16/60075
30/45065
4/16/45065
12/45050

Elimostat Bell Aircraft Solar Type EA 105 \$3.95

RL 9 or RL 7
 Interphone Amplifier Convert to High Fidelity Phone Amp. or Spch. Amp. Complete w/12A6, 12SL7, 2 Chokes, 1XFRMR DYN for 24v operation. etc. \$2.75

MODEL GO-9 TRANSMITTER
 All Brand New. 100 Watts CW. or MCW emission. Operates from 110 V. 800 Cycle, easily converted to 60 Cycle operation. Low frequency range, 3000 KC. to 18,000 KC. using an E.C.C. We furnish complete conversion data with each transmitter. Complete with schematics \$69.95

BC-604-FM TRANSMITTER 20-22 Mc.
 11 and 15 meters. Ideal for C.D. Can be put on 10-meter, 10-channel, push-button control. Complete with tubes and dynamotor. Used. Excel. cond. \$19.95

PRECISION RESISTORS

1.01	128	2230	30000
3	150	4300	33000
5	200	5000	35000
5	250	7500	40000
10.1	300	8500	50000
15	430	10000	55000
43.5	468	12000	57000
50	800	17000	75000
75	920	17300	We ship
82	1000	20000	type 10
120	1100	25000	stock
125	1450		
Above Ea. 30¢			
100000	150000	200000	
120000	170000	220000	500000
Above Ea. 40¢			Ten For. \$3.50

1,000,000 ohms Each 75¢

W.E. PRECISION RESISTORS

D-164886A 2.65 ohms
 D-164886AA 3.83 ohms
 D-167026 13,500/10,500 ohms
 D-162025AT 1400/135/270 ohms
 D-164285 40,600/1500 ohms
 D-168360EL 11.55 ohms
 D162707CY 2500 ohms
 D-171862 279 ohms
 D-171863 591 ohms
 D-164286 10,000/15,000/62,000 ohms
 D-164284 100,000/50,000 ohms
 D-172241 400/600/700/750 ohms
 @ 75c ea.

All merch. guar. Mail orders promptly filled. All prices F.O.B. N.Y.C. Send MO or Chk. Only shipping chgs. sent C.O.D. Rated concerns send P.O. MIN. ORDER \$3.00

COMMUNICATIONS EQUIPMENT CO.

131 Liberty St., New York, N. Y. Dept. E-7 Chas. Rosen Phone: Digby 9-4124

COMMUNICATIONS
EQUIPMENT CO.**AN/APS-4 RADAR**COMMUNICATIONS
EQUIPMENT CO.

Airborne Search-Intercept equipment—A light weight airborne equipment for operation at frequencies in the X Band designed primarily for use on the Navy's carrier-based planes. It can be employed to perform the following functions on any type aircraft.

1. Radar Search operation over large bodies of water for the detection of vessels on the surface.

2. Mapping and navigational operation.

3. Detection and location of other aircraft to permit their interception.

4. Picking up the coded signals from the beacon stations in the X-band to facilitate the return of the searching plane.

5. Operation as the search element in conjunction with identification equipment.

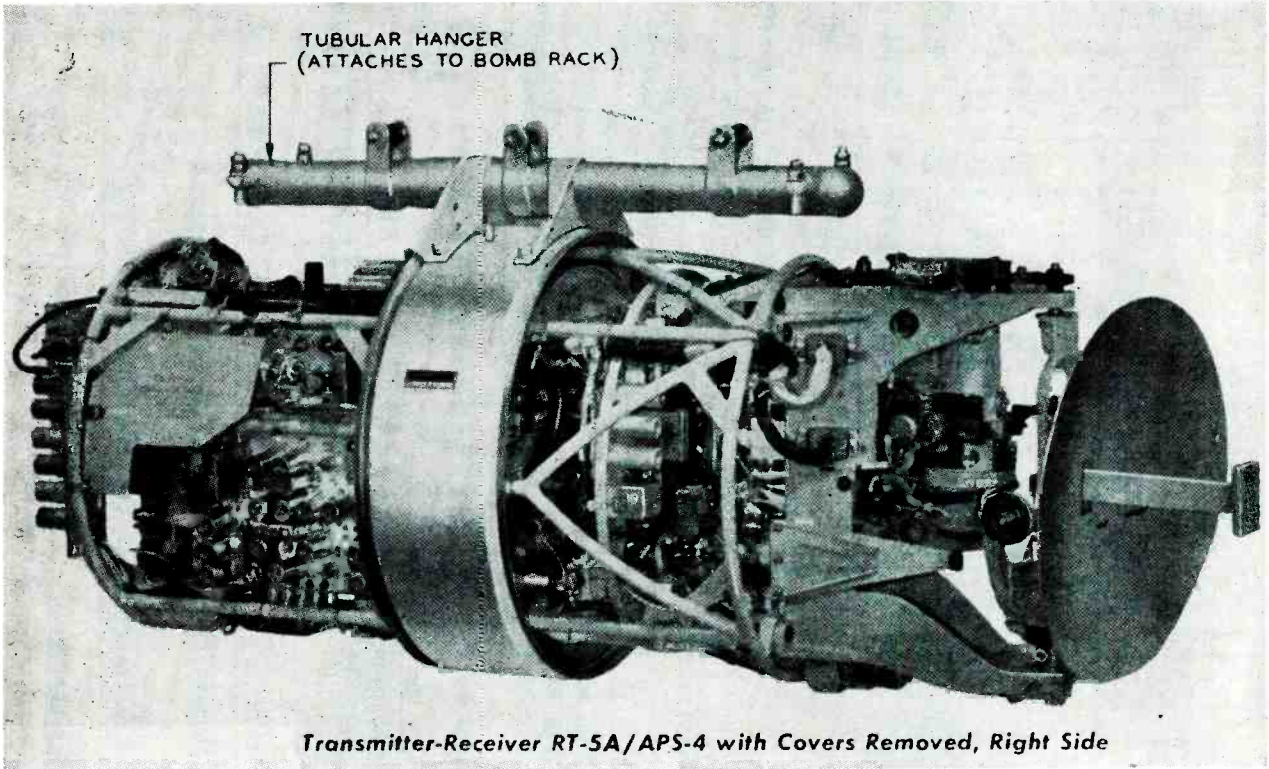

Transmitter-Receiver RT-5A/APS-4 with Covers Removed, Right Side

Complete Installation—Packed—Write for Price and Details—"Underbelly Assembly" As Illustrated Less Tubes \$375

This equipment searches by use of a "nodding" and sweeping paraboloid antenna which emits a beam of RF pulses into space and receives reflected pulses back from targets in the path of the emitted beam. The received pulses, together with "antenna position" information and time they are received, are displayed on indicators in a manner which determines azimuth and "slant range" of targets within the area searched. The antenna can be oscillated to scan 75 degrees of azimuth on either side of dead ahead and can be tilted vertically to direct the beam at any angle from 10 degrees above horizontal axis of the plane to 30 degrees below that axis but, due to "leakage" of the radiated beam, the "30 degree below axis" antenna position affords sufficient radiation to scan directly below the plane and for a considerable distance surrounding that point, which makes it ideal for detection of SUBMARINES. Nominal ranges of operation for this equipment are as follows:

- (1) Ships 30 Miles
(2) Aircraft 3 Miles
(3) Land Targets 75 Miles

Power requirements for the complete equipment are as follows:
28 volts DC — 3 to 4 amps. or 115 Volts — 800 to 2400 cwc AC, 6 amps.
Frequency of operation is in the order of 9, 310-9, 375 MCS.

(a) Receiver — Transmitter Unit
1. RT-5A/3PS-4

The receiver-transmitter is contained within a "bomb-shaped" fibre-composition housing and is commonly called the "bomb." The bomb-unit is sealed and pressurized on the ground with dry air to a gage pressure of 5 lbs. per square inch. It is usually mounted beneath the plane's lower wing and supported in a standard Navy bomb rack whereby (in emergency) the pilot can dispose of the unit by activating the release mechanism. Located in the nose of the "bomb" is the paraboloid reflector and wave-guide feed antenna. The transmitter portion comprises four major circuits, namely:

- (1) Triggering Circuit (3) Discharge Circuit
(2) Charging Network (4) Magnetron Oscillator

The charging network is charged to a high potential, then rapidly discharged through a pulse transformer which impresses a large negative voltage of short duration to the cathode of a "grounded-plate" magnetron oscillator which causes the magnetron to vigorously oscillate for the duration of its cathode impressed pulse, and send forth to the antenna a powerful burst of RF energy at a frequency of 9, 375 MC. The triggering circuit initiates the pulse which causes the discharge of the network. When the magnetron oscillator "fires" its burst, that energy passes through a T-R Box enroute to the antenna. The T-R Box acts as a valve which functions to isolate the receiver input from the transmitter output, yet when the weaker reflected signals are picked up by the antenna, this same T-R Box allows that weak signal to be accepted by the receiver portion undamped by the transmitter portion of the equipment because of its isolation. The incoming signal, after clearing the T-R Box, is then mixed with the output from a local oscillator in a crystal converter from the output of which is picked off a 60 MC IF signal. There are two local oscillators, one of which is used during SEARCH and INTERCEPT operations and is tuned to 60 megacycles above the transmitter frequency while the other (used for BEACON operation) is tuned to 60 Mc below the transmitter frequency. The 60 MC signal is fed into 2 stages of IF preamplification which is then followed by 5 single-tuned RF stages.

Following this a 6AK5 detector (connected as a cathode follower feeds the video amplifier. Part of the output from the 2-stage preamplifier is used to energize an AFC circuit which controls the frequency of the local oscillator. At the video amplifier (which is a separate unit from the Receiver-Transmitter) the video echo signals are mixed with RANGE MARK PIPS and the combination is applied to cause signal indications to appear on indicator screen which describe the range of the object from which the initial transmitter output signal was reflected.

Tube Complement:

1 ea. — JAN 1B22	1 ea. — 725A
4 ea. — JAN 3B24	1 ea. — JAN 807
3 ea. — JAN 6J6	

TRANSMITTER PORTION

6 ea. — JAN 6AK5	IF AMPLIFIER PORTION
15 ea. — JAN 6J6	RANGE AND ALARM UNIT
	1 ea. — JAN 6AK5

LOW VOLTAGE POWER SUPPLY

3 ea. — JAN 5U4G	1 ea. — JAN 6SL7GT
1 ea. — JAN 6J6	1 ea. — OC3/VR105-30
5 ea. — JAN 6V6GT	4 ea. — OD3/VR150-30

RECEIVER PORTION

2 ea. — JAN 6J6	2 ea. — 723A/B
3 ea. — JAN 6AK5	2 ea. — 724A
1 ea. — JAN 6SL7GT	

CONTROL AMPLIFIER PORTION

1 ea. — JAN 6AK5	2 ea. — JAN 6J6
------------------	-----------------

BEACON TUNER PORTION

1 ea. — JAN 6J6

(b) Indicator—Amplifier 1. AM-5A/APS-4
Consists of video amplifier and range-mark generator circuits. The range-mark pips are mixed with the receiver video signal, amplified and fed into a cathode follower stage; the output of which is used to feed the cathode-ray indicator proper.
Tube complement:
2 ea. — JAN 6J6 2 ea. — JAN 6SL7GT 4 ea. — JAN 6V6GT

(c) ID-11/APS-4 Indicator
Employs a 3EP7 cathode-ray tube with a 6J6 acting as a diode DC resistor and a second 6J6 functioning as a push-pull amplifier. Displays the information which the AN/APS-4 is designed to compute and gather.
Tube complement:
1 ea. — JAN 3EP7 2 ea. — JAN 6J6

(d) C-12A/APS-4 Control Box
Comprises beacon-search, intercept-search, and warning on-off toggle switches, range and tilt controls, receiver gain control, and F.R.S. control knob. For controlling the AN/APS-4 equipment.

(e) J-84/APS-4 Junction Box
Mounts within the aircraft and forms junctions between Indicator-Amplifier Units, Control Box, and the Receiver-Transmitter of the AN/APS-4 equipment.

(f) Bomb-Rack Attaches rigidly to the plane and contains the mechanism for releasing the receiver-transmitter "bomb" if necessary.

All merch. guar. Mail orders promptly filled. All prices, F.O.B. N.Y.C. Send M. O. or Chk. Only shipping chgs. sent C.O.D. Rated concerns send P.O.

COMMUNICATIONS EQUIPMENT CO.

131 Liberty St., New York, N. Y. Dept. E-7

P. J. PLISHNER

Phone: Main 4-8373

**MOTOR GENERATORS
DYNAMOTORS, INVERTERS, ETC.**

2.5 KVA MG Set. Diehl Elec. Co. 120V D.C. to 120V A.C. 60 cy. 1 Ph., 4PF. Complete with Magnetic Controller, 2 Field Rheos and Full Set of Spare Parts including Spare Armatures for Generator and Motor. Full specs. on request. New \$285.00

2 KVA MG SET. O'Keefe and Merritt. 115V DC to 120V AC, 50 cy. Idles at 3 Ph. syncs motor on 208V, 50 cy. New. Export crated \$165.00

1.25 KVA MG SET. Allis-Chalmers. 230 DC To 120 AC, 60 cy. 1 Ph. Fully enclosed. Splashproof Ball Bearings, centrifugal starter. New, complete with kit of Spare Parts...\$150.00

MG Set. Onan MG-215H. Navy type PU/13. Input 115/230, 60 cy. 1 Ph. Output 113, 480 cy. 1 Ph. 1200W and 26V DC at 4 amps. New.....\$295.00

MG SET FOR NAVY TBS TRANSMITTER. Type CG-21302. 440V AC, 60 cy, 3 Ph, 1500 VA to 875 DC and 300V DC. New\$69.50

DYNAMOTOR. Navy-Type CAJO-211444. 105/130V-DC to 13V DC at 40A or 26V DC at 20A. Radio filtered. Complete with Line Switch. New. \$69.50

DYNAMOTOR. Elcor. 64V DC to 110V AC, 80 cy. 1 Ph. 2.04 Amps. New.....\$24.50

DYNAMOTOR. Elcor. 32V DC to 110V AC, 80 cy. 1 Ph. 0.43 Amps. New.....\$17.50

DYNAMOTOR — Type PE94C. For use with SCR522 Transmitter-Receiver. Brand new in export cases\$9.50

AMPLIDYNE—G. E. Model 5AM21J37. 4800 R.P.M. Motor Compound wound. 150 Watts. Input: 27V. DC. Output: 60V. DC Sig Corps. U. S. Army MG-27-B. New.....\$26.50

AMPLIDYNE—Edison type 5AM31N18A. Input: 27 volts 44 Amps, 8300 RPM. Output: 60V DC at 8.8 amps. 530 Watts. New.....\$22.50

INVERTER—G.E. Model 5D-21N38A. Input: 24V. DC, Output: 115V. 400 cy. 485 Va. New.....\$24.50

INVERTER—Leland Elec. Co. Model PE208A. Input: 28V. DC, 38 Amps. Output, 80V., 800 cy, 485 VA. New\$17.50

PE 218 INVERTER—G. E. J8169172. Input: 28V. DC, Output: 115, 400 cycles at 1.5 KVA...\$24.50

GENEMOTOR—Carter 6V DC to 400 V DC at 375 mils. New\$39.50

D.C. MOTOR—G.E. Model 5BA50L2A. Armature 27V D.C. at 8.3A. Field 60 V D.C. at 2.3A. RPM 4000. H.P. 0.5. New\$22.50

MOTOR GENERATOR M.G. 164. Holtzer-Cabot Motor: 440V, 3PH, 60 cy., .90A, 1/3HP, 1750 RPM. Generator: 70V, 3Ph, 146 Cy., .140KVA Exciter: 115DC, 1A. New.....\$67.50

BC-348 RECEIVER PARTS

Dial Mechanism assemblies. 1st, 2nd, 3rd, 4th I.F. transformers. C.W. osc. and xtal filter trans. with xtals. All R.F. coils. Front panels. Shock mounts. Large quantity misc. hardware sub assemblies, etc. Write your requirements.

MISCELLANEOUS EQUIPMENT

TS-127/U Lavoie Freq. Meter—375 to 725 MC.
TS-47APR Test Set—40 to 500 MC.
213-A DuMont C.R. Modulation Monitor.
BC1203B APN-4 Test Set.
6255A H.P. Interpolation Osc.
TS-23/APN Test Set.
TS-487/U Peak to Peak VTVM.
BC-221AE Freq. Meter.
LM-13 Freq. Meter.

All prices indicated are F O B Bronxville, New York. Shipments will be made via Railway Express unless other instructions issued.

MICROWAVE RECEIVERS

AN/APR-1 Receivers and tuning units TN-1 (38 to 95 MC) TN-2 (76-300 MC) TN-3 (300-1000 MC).
AN/APR-4 Receivers and tuning units TN-16 (38-95 MC) TN-17 (76-300 MC) TN-18 (300-1000 MC).
R111A/APR-5A Receivers. 1000 to 6000 MC Range.

**MODEL AN/APA-10
PANORAMIC ADAPTER**

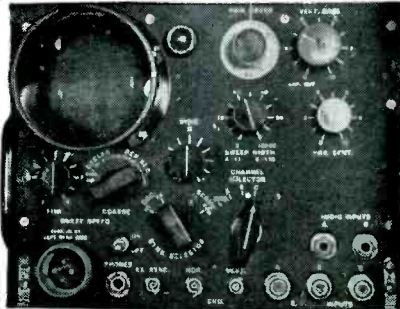

Provides 4 Types of Presentation:
(1) Panoramic (2) Aural
(3) Oscillographic (4) Oscilloscopic

Designed for use with receiving equipment AN/ARR-7, AN/ARR-5, AN/APR-4, SCR-587 or any receiver with I. F. of 455kc, 5.2mc, or 30mc.

SUMMARY OF CHARACTERISTICS:

SENSITIVITY: "A" channel, 400 microvolts or less per 1/4" beam deflection. "B" channel, 400 microvolts or less per 1/4" beam deflection. "C" channel, 1 volt or less per 1/4" beam deflection.
RESOLUTION: 12 kilocycles at 3 db down from peak, sweep control at maximum, using CW signal.
PRESENTATION: Panoramic ("A" & "B" channels); Oscillographic, "C" channel.

SWEEP WIDTH: Channel A, ± 50 kc (100 kc overall) Channel B, ± 500 kc (1 Mc overall) Channel C, ± 1 Mc (2 Mc overall).

CATHODE RAY SWEEP: Oscillatory or non-oscillatory (Sawtooth) Variable Sawtooth Generator, 35 to 40,000 cycles per second.

AUDIO OUTPUT: 50 milliwatts into 600 or 8000 ohm load.

VERTICAL AMPLIFIER: Single stage, ± 2db from 30 cycles to 100 kc or higher. Amplifier out position permits direct connection to one vertical plate through coupling capacitor.

HORIZONTAL AMPLIFIER: Single stage, ± 2db from 30 cycles to 100 kc. No provision for direct connection to deflection plates.

CATHODE RAY TUBE VOLTAGE: Cathode to accelerating anode; 1200V DC for 115V A.C. input.

SENSITIVITY OF CATHODE RAY OSCILLOSCOPE: Maximum through Amplifier. Horizontal: 10 volts peak to peak per inch. Vertical: 1.5 volts peak to peak per inch.

DIRECT TO VERTICAL PLATE: 150 volts peak to peak per inch.

NOISE: No disturbance in excess of 25,000 microvolts between 200kc to 200Mc generated by equipment. Overall Dimensions: 19-9/16" x 10 1/4" x 7 7/8". Weight: 40 lbs.

Power Requirements: 115V. A.C. 60 cycles, 1 phase. With 21 tubes including 3" scope tube, for operation on 115 V. 60 cycle source. PRICE.....\$245.00

AN/APA-10 80 Page Tech Manual.....\$2.75

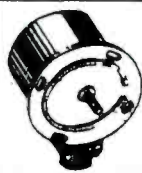

**LINEAR SAWTOOTH
POTENTIOMETER
W.E. KS-15138**

Has continuous resistance winding to which 24 volts D.C. is fed to two fixed taps 180° apart. Two rotating brushes 180° apart take off linear sawtooth wave voltage at output.
Brand New \$5.50

G. E. SERVO AMPLIFIER

Type 2GV1C1 Aircraft Amplidyne control amplifier. 115 volts—400 cycles. Dual channel. Employs 2-6SN7GT and 4-6V6GT tubes. Supplied less tubes. New\$22.50

400 CYCLE TRANSFORMERS

AUTO. 400 cy. G.E. Cat No 80G184. KVA .945S—520P. Volts 460/345/230/115. New. \$4.95

FILAMENT. 400/2600 cy. Input: 0/75/80/85/105/115/125V. Output: 5V3A/5V3A/5V3A/5V3A/5V6A/5V6A/6.3V6A/6.35A. New\$2.95

THYRATHRON POWER. 400/1800 cy. Raytheon UX-8876, 400/1600 cy. Pri: 115, Sec: 50-0-50V at 1.5A, 6.3V at 1.2A. Test r.m.s. 1780. New..\$2.75

PLATE WECO KS9560. 400/800 cy. Pri: 115V. Sec: 1350-0-1350 at .057A (2700 V Total). Elestat shielded. Wt. 2.3 lbs. New.....\$2.95

Plate. Thordarson #T46889. 1650 VA. Pri: 105-120V. 500 cy. 1 PH. Sec: 5600V. Center tapped. 1.5KV insulation. Brand new.....\$49.50

SCOPE PL. & FIL. WECO 9556. 400/2400 cy. Pri: 115. HV Wdg. 1125V at .008A. Fil. Wdgs. 6.4V4A/2.5V1.75A/6.4V.6A. Elestat shielded. Wt. 1.4 lbs. New\$2.75

FILAMENT. 400/2400 cps. WECO KS9553. Pri: 115V. Sec: 8.2V1.25A/6.35V1.5A Elestat shielded. Wt. 0.5 lbs. New\$1.95

PLATE & FIL. 400/2600 cy. Pri: 0/80/115V. Sec: #1=1208VDC at 1.5MA. Sec. #2=400VDC at 130MA. Fil. Secs: 6.4V4.3A/6.35V0.8A. (Ins. 1500V)/5V2A/5V2A\$4.95

RETARD. 400 cy. WECO KS9598. 4 Henry 100MA\$1.75

60 CYCLE TRANSFORMERS

FILAMENT. Raytheon Hypersil Core, Pri: 115V. Sec: 6.3V22A/6.3V2.4A/6.3V2.25A/6.3V0.6A. Ins. for 1700V\$9.95

High Rectance Trans. G. E. type Y-3502A—60 cy. Voltage 11200-135. Inductance H.V. Windng 135 Henries. Output: Peak Voltage 22.8KV. Cat. 8318065G1. New\$89.50

High Voltage Trans. Westinghouse Pri: 115. 60 cy. Sec: 15,000 C.T., 60 MA. Good for Hi-Pot test set up\$24.50

PULSE TRANSFORMERS

PULSE. WECO KS-9563. Supplies voltage peaks of 3500 from 80V tube. Tested at 2000 Pulses/sec and 5000V peak; Wdg. 1-2=18 ohms. Wdg. 1-3=72 ohms. L of Wdg. 1-3=073-.082H at 100 cps. \$5.00
PULSE. WECO KS-161310. 50 KC to 4Mc. 1 1/2" Dia. x 1 1/2" high. 120 to 2350 ohms. New\$1.95

RAYTHEON VOLTAGE REGULATOR

Adj. input taps 95-130V., 60 cy. 1 Ph. Output: 115V., 60 Watts, 1/2 of 1% Reg. Wt. 20 lbs. 6 1/4" H x 8 1/4" L x 1 1/2" W. Overload protected. Sturdily constructed. Tropicalized. Special.....\$14.75

HIGH VOLTAGE CAPACITORS

25 MFD., 20KV\$26.50
25 MFD., 15KV22.50
.5 MFD., 25KV34.50
1 MFD., 15KV34.50
1 MFD., 7.5KV12.50

SOUND POWERED PHONES

Western Electric No. D173312, Type O. Combination headset and chest microphones. Brand new including 20 ft. of rubber covered cable.....\$17.50
Automatic Elec. Co. No. GL843AO. Similar to above but including Throat microphone in addition to chest microphone. Brand new with 20 ft. rubber covered cable\$10.00
U. S. Instrument Co. No. A-260. Complete with 20' cable and plug. Brand new.....\$13.50
W. E. type TS-16M Handset. New.....\$16.50

PARABOLOIDS

Spun Magnesium dishes 1 1/2" dia. 4" deep. Mounting brackets for elevation and azimuth control on rear. 1 1/2 x 1 1/2" opening in center for dipole. Brand new, per pair.....\$8.75

SWEEP GENERATOR CAPACITOR

High speed ball bearings. Split stator silver plated coaxial type 5/10 mmfd. Brand new.....\$2.50

WESTERN ELECTRIC CRYSTAL UNITS

Type CR-1A/AR. Available in quantity—following frequencies—fundamentals.
5910—6350—6370—6470—6510—6610—6670—6690—6940—7270—7350—7380—7390—7480—7580—9720—Kilocycles.

\$1.25 each

**ELECTRONICRAFT
INC.**

27 MILBURN ST. BRONXVILLE 8, N. Y.
PHONE: BRONXVILLE 2-0044

All merchandise guaranteed. Immediate delivery, subject to prior sale.

All Prices Subject to Change Without Notice

Reliance Specials

TIMING MOTOR
8 RPM 1115V 60 cyc
E. Ingraham Co.  **\$1.95**

GEAR ASSORTMENT
100 small assorted gears. Most are stainless steel or brass. Experimenters dream!..... Only \$6.50

VERNIER DIAL or DRUM (From BC-221)
DIAL—25% dia. 0-100 in 360°. Black with silver marks. Has thumblock. DRUM—0-50 in 180°. Black with silver marks.....either, 85c

SOUND POWER HANDSET

 **Brand New!**
Includes 6 ft. cord. No batteries or external power source used. **\$17.60 pr.**

Sound Powered Chest Set RCA—With 24 Ft. Cord
 **\$17.60 per pair**

Variac—General Radio
100W removed from equipment **\$10.00**

400 CYCLE INVERTERS

Leeland Electric Co.
#10800 In: 20-28 V.D.C. 92 A. 8000 R.P.M. Out: 115V.
400 Cyc. 1 phase, 1500 V.A. 90 1P.....\$12.95

3AG FUSES

AMP	Per 100	3AG	Per 100	AMP	Per 100
1/4	\$4.00	1	3.00	6	\$3.00
1/2	4.00	1 1/2	3.00	10	3.00
3/4	4.00	5	3.00	15	3.00

DELAY NETWORK—ALL 1400

T 113—Approx. 1.2 micro sec. delay..... 95c
T 114—Approx. 2.2 micro sec. delay..... each
T 115 Similar to T 114 with tap brought out.....

BEARINGS

Mfd. No.	ID	OD	Thickness	Price
MRC5028-1	5 1/2	6 1/2"	1"	\$3.50
MRC7026-1	5 5/8	6 15/8"	9/16	3.50
Timken 37625	4 5/16	6 1/4	29/32	4.25
MRC-7021-200	4 1/8	5 9/32	23/64	2.95
Fafnir B545	2 1/16	2 5/8	1/4	1.00
MRC 106 M2	1 17/64	2 7/16	25/64	1.75
MRC 106 M1	1 13/64	2 7/16	25/64	1.60
Federal LS 11	1 1/8	2 1/2	5/8	1.75
Norma S 11 R	1 1/8	2 1/8	3/8	1.25
Fafnir B 541	1 1/16	1 1/2	9/32	.55
Hoover 7203	5/8	1 9/16	7/16	.90
Norma 203 S	3/8	1 9/16	7/16	.90
Schatz	3/4	1 3/4	9/16	1.00
N5 5202-C13M	1/2	1 3/8	1 3/8	1.00
ND 3200	25/64	1 5/32	11/32	.55
Fafnir S 3K	3/8	7/8	7/32	.45
MRC SW R1	11/32	1 3/32	5/16	.45
ND CW 8008	5/16	5/16	13/32	.45
MRC 38 R3	3/8	1 5/8	9/32	.45
Fafnir 33K5	3/16	1/2	5/32	.25

NEEDLE BEARINGS

TORRINGTON B108 1/2" wide 5/8" 13/16" 30c

Brand New METERS—Guaranteed

0-1 Amp. R.F. 2 1/2" \$3.29 | 0-30 Amp. D.C. 2 1/2" \$2.25
0-7.5V. A.C. 3 1/2" 3.46

SELENIUM RECTIFIERS

Full Wave 200 MA 115V.....\$1.79
Half Wave 100 MA 115V......91
SPAGHETTI SLEEVING—assortment—99 feet.....\$1.00

TYPE "J" POTENTIOMETERS

150	300	300	400	500	1000	1000	1000	1500
SD	SD	SD	SD	SD	SD	SD	SD	SD
2000	2000	2000	2000	2000	2000	2000	2000	2000
1/2"	1/2"	1/2"	1/2"	1/2"	1/2"	1/2"	1/2"	1/2"
5000	5000	5000	5000	5000	5000	5000	5000	5000
3/8"	3/8"	3/8"	3/8"	3/8"	3/8"	3/8"	3/8"	3/8"
15K	15K	15K	15K	15K	15K	15K	15K	15K
SD*	SD*	SD*	SD*	SD*	SD*	SD*	SD*	SD*
1 Meg	1 Meg	1 Meg	1 Meg	1 Meg	1 Meg	1 Meg	1 Meg	1 Meg

* Split locking bushing **\$1.25 each**

JONES BARRIER STRIPS

Type	Price	Type	Price	Type	Price
2-140Y	\$0.13	4-141W	\$0.30	9-141Y	\$0.64
3-140Y	.19	5-141W	.26	10-141Y	.50
6-140	.25	7-141 1/2W	.37	17-141Y	1.17
10-140 3/4W	.53	7-141 1/2	.36	3-142	.21
2-141	.13	7-141 3/4W	.49	8-142	.69
3-141 1/2W	.14	8-141 3/4W	.58	2-150	.39
3-141W	.24	9-141	.64	3-150	.54

TIME DELAY RELAY

 Raytheon CPX 24166 KS 10193-60 Sec.
115 V., 60 cycle • Adj. 50-70 Seconds •
2 1/2 second recyling time—spring return •
Micro switch contact, 10A • Holds ON as long as power is applied • Fully cased •
ONLY \$6.50

AN CONNECTORS

IMMEDIATE SERVICE
PHONE! WIRE! WRITE! YOUR NEEDS

NEW COAXIAL CABLES

Price per 1,000 Ft.		Price per 1,000 Ft.	
Ohms		Ohms	
RG-6/U	76	RG-35/U	71
RG-7/U*	97.5	RG-37/U	55
RG-15/U	76	RG-39/U	72.5
RG-21/U	53	RG-41/U	67.5
RG-22A/U*95	150	RG-54/U	58
RG-24/U	125	RG-55/U	53.5
RG-25/U	43	RG-57/U*	95
RG-26/U	48	RG-58/U*	53.5
RG-27/U	48	RG-59/U*	70
RG-29/U*	53.5	RG-77/U*	48
RG-34/U	71	RG-78/U*	48

Add 25% for orders less than 1,000 feet.
*No minimum order—others 250' minimum.

COAXIAL CABLE CONNECTORS



15c	30c	80c	45c	9c	
UG 175/U	83-1F	ANGLE	83-1J	83-1R	
83-1AC	\$.42	83-22J	\$1.40	UG58/U	\$.63
83-1AP	.30	83-22SP	1.15	UG59A/U	2.25
83-1F	1.30	UG-12/U	.63	UG60/U	2.40
83-1H	.09	UG13/U	.63	UG85/U	.88
83-1J	.80	UG19B/U	1.95	UG88/U	1.25
83-1R	.45	UG21/U	.67	UG88/U	1.25
83-188	1.25	UG22/U	1.10	UG167/U	2.00
83-185	.15	UG24/U	.67	UG175/U	.15
83-2AP	2.00	UG25/U	.60	UG176/U	.15
83-2H	.25	UG27/U	.68	UG201/U	2.05
83-2J	1.65	UG27A/U	2.95	UG206/U	.63
83-2R	1.30	UG29/U	.83	UG281/U	.60
83-21SP	2.10	UG30/U	2.50	UG290/U	1.15
83-22AP	2.10	UG37/U	2.30	UG499/U	1.25

DIFFERENTIAL

115 V., 60 Cyc. #C78249 **\$3.95 ea.**

 3 3/8" dia. x 5 3/4" long
Used between two #C78248's as dampener. Can be converted to 3600 RPM Motor in 10 minutes. Conversion sheet supplied. (Converted).....\$4.50
Mounting Brackets— (Lakelite for selsyns, and differentials shown above..... 35c pair

2J1G1 SELSYNS \$2.95

BRAND NEW 400 CYCLE
Can be used on 60 cycle

POSTAGE STAMP MICAS

MMF	MMF	MMF	MMF	MMF	MFD	MFD
8.2	40	90	240	510	.0011	.0051
10	43	100	250	560	.0012	.006
15	47	110	270	580	.0013	.0062
20	51	120	300	600	.00136	.0065
22	56	125	350	620	.0015	.0068
24	60	130	370	680	.001625	.007
25	62	150	390	800	.002	.0075
26	68	160	400	820	.0026	.008
30	75	175	430	910	.0027	.0082
35	82	180	470	MFD	.003	.009
39	85	220	500	.001	.0033	.01

Price Schedule

.82 MMF to .001 MFD..... 5¢
.0011 MFD to .001625 MFD..... 7¢
.002 MFD to .009 MFD..... 12¢
.01 MFD..... 22¢

SILVER MICAS

MMF	MMF	MMF	MMF	MMF	MMF	MFD
10	51	120	270	470	875	.00282
18	60	125	300	488	900	.002826
20	62	150	325	500	MFD	.003
22	66	170	360	510	.001	.0033
23	69	180	370	525	.0011	.0039
24	75	200	390	560	.001625	.005
30	82	205	400	570	.0022	.0051
39	100	225	410	680	.0023	.0056
40	110	240	430	790	.0024	.006
50	115	250	466	800	.0026	.0082

Price Schedule

10 MMF to .001 MFD..... 10¢
.001 MFD to .0024 MFD..... 20¢
.0026 MFD to .0082 MFD..... 50¢

FILAMENT TRANSFORMER

Pri., 115V., 60 Cyc. — Sec. } 6 V. @ 35 A.
or 12 V. @ 18 A. } **\$6.50**
or 24 V. @ 9 A.

PULSE TRANSFORMERS

UTAH—9262 9278 9340
WESTERN ELECTRIC—D166173 D161310
KS8696, KS9365, KS9565, KS9800, KS9862, KS1316
GENERAL ELECTRIC—K2731, 80-G-5
JEFFERSON ELECTRIC—C-12A-1318
CROSBLEY—W-226262-3
DINION COIL—TR1048 TR1049
also 352-7250-2A; 352-7251-2A; T-1-229621-60

PRECISION RESISTORS

1/4 WATT—30c

2	10.48	12.32	16.37	125	705
2.5	10.84	13.02	32	147.5	2,198
3.5	11	13.52	62.54	220.4	3,500
5	11.25	13.89	79.81	301.8	59,148
6.68	11.74	14.98	105.8	366.6	
		15.8	123.8	414.3	

1/2 WATT—30c

.1	13.3	120	855	5,900	31,500
.2	13.52	123.8	900	6,000	32,700
.250	15	125	970	6,500	32,888
.334	18.75	147.5	1,060	7,000	33,000
.444	20	148.7	1,100	7,800	33,300
.502	21.5	150	1,150	7,500	33,888
.557	25	178	2,200	8,000	36,000
.627	30	179.5	1,264	8,500	37,000
.67	34.75	180	1,375	8,800	39,000
1	40	210	1,400	8,900	40,000
1.01	44.73	220	1,490	9,000	41,700
1.02	45	230	1,500	10,000	43,788
2	46	235	1,573	12,000	45,000
2.04	49	240	1,876	13,333	47,000
2.5	50	250	2,230	14,825	50,000
2.54	52	260	2,250	15,000	56,000
3.07	55.1	270	2,500	15,750	59,000
3.25	60	286	2,850	15,755	59,905
3.7	61	290	3,330	15,810	68,000
3.87	65	298.3	3,400	16,000	70,000
5.24	66	389	3,427	16,700	75,000
5.26	66.6	397	3,500	17,000	79,012
5.89	69	400	3,995	19,860	80,000
7	70	500	4,000	20,000	90,000
7.6	71	600	4,101	20,150	92,000
8	75	607	4,285	23,300	100,000
10	80	705	4,300	22,500	120,000
10.58	87	723.1	4,451	23,300	140,000
11.1	90	785	4,750	25,000	180,000
13.15	97.8	800	5,000	26,667	400,000
100			5,714		

METERS

3 MA DC 2 1/2" R.—Simpson black scale.....	\$3.35
500 Microamps, DC—2 1/2" round—Sun.....	4.30
1 ma. DC Fan type—4" scale (from equip't).....	3.95
500 ma. DC 2 1/2" R.—General Electric.....	2.95
2 amp. RF 2 1/2" Sq.—Simpson.....	3.15
5 amp. AC 4 1/2" R.—JBT.....	4.11
10 amp. RF 3 1/2" R.—Simpson.....	4.95
50 amp. AC 3 1/2" R.—General Electric.....	4.11
3 amp. RF 3 1/2" R.—Weston.....	6.00

MAGNETRONS

2J21A	2J36	2J61	706CY
2J22	2J37	5J23	706FY
2J26	2J38	5J29	706GY
2J27	2J39	700B	714AY
2J31	2J40	700C	718AY
2J32	2J41	700D	720B/C/DY
2J33	2J48	706AY	725A
2J34	2J49	706BY	730A

KLYSTRONS

2K23	2K33	707A	726A
2K25	2K54	707B	726B
2K26	2K55	723A	5611
2K29	417A	723A/B	

OIL-FILLED HIGH VOLTAGE ISOLATION TRANSFORMERS

Pri. 460V 60 cy. Sec. 115V 200VA Insulated for 50KV DC—G. E. Form E1R—36" H x 13"D.....\$125.00
 Pri. 115V 60 cy. Sec. 115V 250VA Insulated for 35KV DC—G. E. Form E1R—29" H x 12 1/2" D.....\$125.00

VOLTAGE DIVIDER

G. E. Cat. 8248886G-I and 9001934G-I 17,246,400 ohms 35KV 70:1 ratio wire wound shielded oil-filled 40" H x 12"D.....\$77.50

2φ LOW INERTIA SERVO MOTORS

KOLLSMAN Type 936-0240—85/68V 100 cy 5 watts 2650 RPM—new
 DIEHL Type FPE-25-11 75V 60cy 4 watts—new.....\$34.50

OIL FILLED CONDENSERS

MFD	VDC	Price	MFD	VDC	Price
2	600	\$.45	1	2500	.49
4	600	1.25	1	2500	3.45
4	600 R'd	1.75	32	2500	15.80
6	600	1.65	3x.2	4000	2.95
8	600 R'd	1.39	1	5000	4.88
10	600 R'd	1.52	.01-.03	6000	1.65
8-8	600	1.49	1	7000	1.79
1	1000	.62	2	12500	28.95
2	1000	.89	.045	16KV	4.70
4	1000	1.65	.05	16KV	4.95
8	1000	2.45	.075	16KV	8.95
1	1500	.89	.25	20KV	18.95
4	1500	2.95	50	220VAC	3.95
1-.5	2000	.87	7	660VAC	4.25
1	2000	1.50	8	660VAC	4.50

HIGH VOLTAGE TRANSFORMERS

G. E.—Pri. 115V 60 cy Sec. 6250V 80 MA—12.5 KV Ins.....\$18.50
 G. E.—Pri 115V 60 cy. Sec. 6250V/3850/2600V 56 MA 12.5 KV Ins.....\$18.50
 Raytheon—Pri. 115V 60 cy. Sec. 8500/6450V CT 43 MA Hermetically sealed.....\$22.50

CRYSTAL DIODES

1N21	\$1.19	1N23	\$1.49	1N34	\$.79
1N21A	1.69	1N23A	3.25	1N38	1.66
1N21B	3.75	1N23B	5.25	1N45	.94
1N22	1.09	1N27	1.79	1N52	1.05

ANTENNAS

AT-38A/APT (70 to 400MC).....\$13.70
 AT-49/APR-4 (300 to 3300MC).....13.70
 DZ-2 Loop antenna with pedestal.....14.50
 AN-74B (125 to 150MC).....1.65
 AN-65A (P/O SCR-521)......95
 AN-66A (P/O SCR-521).....1.15
 ATA—3CM conical scan.....125.00
 ASB Yagi—5 element 450 to 560MC.....12.70
 ASB Yagi—Double stacked 6 element.....12.70
 ASA Yagi—Double stacked 370 to 430MC.....29.40

WESTINGHOUSE HYPERSIL TRANSFORMER

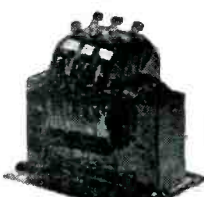

PRI-115V. 60CY 3/4 KVA
 SEC #1 - 240V - 1.56A
 SEC #2 - 240V - 1.56A
 WT. 30 LBS.
\$14.50 EACH

Terms 20% cash with order, balance C. O. D. unless rated. All prices F.O.B our warehouse, Phila., Penna., subject to change without notice.

COAXIAL CONNECTORS



83-1AC	\$.42	83-1R	\$.45	83-22AP	\$1.10
83-1AP	.30	83-1RTY	.65	83-22R	.68
83-1F	1.30	83-1SP	.45	83-22SP	1.15
83-1H	.10	83-1SPN	.45	83-168	.15
83-1J	.80	83-1T	1.30	83-185	.15

FULL LINE OF JAN APPROVED COAXIAL CONNECTORS IN STOCK

UHF	N	BN	BNC
UG-7	UG-23	UG-37	UG-102
UG-12	UG-24	UG-37	UG-103
UG-18	UG-27	UG-58	UG-104
UG-19	UG-27A	UG-83	UG-106
UG-21	UG-29	UG-85	UG-108
UG-22	UG-30	UG-86	UG-109
UG-22B	UG-34	UG-87	UG-167
UG-22B		UG-88	UG-171
			UG-236
			UG-306

M-358	MC-277	PL-259A	PL-325
M-359	MC-320	PL-274	SO-239
M-359A	PL-258	PL-284	SO-264
M-360	PL-259	PL-293	TM-201

93-C	49120	D-163950	ES-685696-5
93-M	49121A	D-166132	ES-689172-1

TYPE "J" POTENTIOMETERS

Resis.	Shaft	Resis.	Shaft	Resis.	Shaft
60	SS	5K	1/4"	50K	3/8"
100	SS	5K	3/8"	50K	1/2"
200	SS	10K	SS	100K	SS
500	SS	10K	3/8"	150K	3/8"
2500	1/8"	10K	1/2"	200K	3/8"
5000	5/16"	15K	SS	250K	SS
5000	1/2"	15K	1/2"	250K	3/4"
5000	5/8"	20K	SS	250K	3/8"
650	1/2"	25K	SS	500K	SS
1K	SS	25K	1/4"	500K	1/4"
2K	3/8"	30K	1 1/8"	500K	7/16"
2500	SS	40K	SS	1 Meg SS	
4K	SS	50K	SS	2.5 Meg SS	
5K	SS	50K	4"	5 Meg SS	

DUAL "JJ" POTENTIOMETERS—\$1.95 each

50	SS	500	SS	1 Meg SS
100	SS	1K	SS	2.5 Meg SS
250	SS	2500	SS	5 Meg SS
330	SS	10K	SS	1K/25K 3/8"

Triple "JJJ" Potentiometers—\$1.95 each.
 100K/100K/100K—1/2" 20K/150K/15K—3/8"

SOUND POWERED TELEPHONES

U. S. NAVY TYPE M HEAD AND CHEST SETS
 U.S.I. A-260 W.E. D-173013
 A.E. GL832BA0
 ANY TYPE—\$14.88 EACH
 TS-10 Type Handsets.....\$8.92 ea.

F. W. BRIDGE SELENIUM RECTIFIERS

AC Volts Input	DC Volts Output	AC Volts Input	DC Volts Output
1.3 Amps	3.85	0.6 Amps	4.60
2.4	4.95	1.2	5.95
6.6	7.75	3.2	8.95
13.0	12.75	6.0	15.50
17.5	15.75	9.0	17.50
26	22.75	12	26.95
39	35.50	18	32.50
52	48.50	25	42.50
70	49.50	36	55.50

130 VAC 1/2 WAVE STACKS

75MA	\$.98	150MA	\$1.30	250MA	\$1.75
100MA	1.10	200MA	1.57	400MA	2.60

GENERATORS

• Eclipse-Pioneer type 716-3A (Navy Model NEA-3A)
 Output—AC 115V 10.4A 800 to 1400cy. 1 φ; DC 30
 Volts 60 Amps. Brand New.....\$38.50
 • Eclipse-Pioneer type 1235-1A. Output—30 Volts
 DC 15 Amps. Brand New—Original Packing.....\$15.50

THYRATRONS & IGNITRONS

OA4G	FG-41	FG-271	722A
CIA	FG-57	393A	873
1C21	FG-67	394A	884
2A4G	FG-81A	25	885
2B4	91	KU-610	1665
2D21	FG-95	KU-623	1904
3C31	FG-105	KU-628	2050
4C35	FG-166	KU-634	2051
C5B	FG-172	WL-652	3550
C6J	FG-178	WL-672	5551
FG-17	RX233A	WL-677	5552
FG-33	FG-235A	WL-681	5557
			5560

TEST EQUIPMENT

• I-22A Signal Generator.....	\$79.50
• V-72K Signal Generator.....	\$48.50
• Vibrotect Mod. 218 Megger.....	\$45.00
• TN-1B/APR-1 Tuning Unit.....	\$95.00
• C-2 Quietone Filter Type IF-16 110/220 V AC/DC	20 Amps.....\$69.00
• TS-127/U Freq. Meter w/spares.....	\$89.50
• TS-143/CPN Oscilloscope.....	\$95.00
• Dumont 175A Oscilloscope.....	\$225.00
• LM-20 Frequency Meter.....	\$49.50
• Gen. Radio 757-PI Power Supply.....	\$27.00
• I-130 A Signal Generator.....	\$70.00
• TS-6/AP Frequency Meter.....	\$42.00
• L & N KS-7470 Null Volt Test Set.....	\$60.00
• A. W. Barber Labs. VM-25 VTVM.....	\$98.00
• TS-10A/APN Delay Line Test Set.....	\$45.00
• TS-19/APQ-5 Calibrator.....	\$75.00
• REL W-1158 Frequency Meter 160-220 MC.....	\$32.95
• CWI-60AAG Range Calibrator for ASB, ASE,	ASV and ASVQ Radars.....\$59.95
• CRV-14AAS Phantom Antenna for Transmitters	up to 400 MC.....\$11.75
3 CM. Pickup Horn Antenna.....	\$9.95
Gen. Radio 736A Wave Analyzer.....	\$600.00

All Items New Except Where Noted * (Exc. Used Condition)

MISCELLANEOUS EQUIPMENT

Amperex IB98 Gamma Counter.....	\$ 9.87
Powerstat I226-115/230V input—0-270V out	@ 9 amp.....37.00
G.E. 2CV2A1 Servo Amplifier.....	6.95
Sbery A-3 Hydraulic Servo.....	3.95
EIMAC 35 TG Ionization Gauge.....	5.95
ATR Inverters 6VDC to 110 VAC 60 cy 75W.....	19.95
ID-6/APN-4 Indicator.....	29.50
R-7/APS-2 Receiver.....	49.50
R-7/APS-15 Receiver.....	49.50
SCR-522 Transceiver.....	36.95
RT-7/APN-1 Transceiver—less tubes.....	6.95
FL-8 1020 cycle filter.....	1.37
RM-29 remote control unit.....	8.95
RM-14 remote control unit.....	8.95
RTA-1B I2/24 V dynamotor.....	40.00
BC-120A Receiver.....	7.95
CY-230/MPG-1 Radar Console.....	575.00
G.E. Type JP-1 portable current transformer.....	32.50
ASB-4 Radar equip. Complete.....	69.75
AN/APN-13 less tubes.....	12.95
T-9/APQ-2 test tubes.....	16.50
BC-645A complete.....	18.95
RCA AVR-15 Beacon Recvr.....	15.50
TBY Trans-Recvr.....	29.95
Pioneer Type 800-1B Inverters—28VDC to 120V	800 cy 7 amp AC (used).....22.65
G.E. Inverter—28VDC to 120 VAC 800 cy	70VA.....39.50
Navy SD-3 Radar complete.....	\$1200.00
Navy DP-14 Direction Finder complete.....	\$385.00

PULSE TRANSFORMERS

UTAH 9262	UTAH 9318
9278	9340
9280	9350
G.E. 68G828	AN/APN-4 Block Osc.
G.E. 68G-627	Phico 352-7149
G.E. K-2469A	Phico 352-7150
AN/APN-8 (901756-501)	Phico 352-7071
AN/APN-9 (901756-502)	Phico 352-7178
AN/APN-9 (352-7250)	Raytheon UX-7350
AN/APN-9 (352-7251)	W.E. D-161310
Westinghouse 132-AW	W.E. D-163247
Westinghouse 232-AW2	W.E. D-163325
Westinghouse 232-BW2	W.E. D-164661

AN/APA-23 RECORDER

Sweeps any receiver through its tuning range and permanently records frequency and time of received signals on paper chart. Power input—(motor) 27V DC 1.5A, and (recorder) 80/115V AC 60-2600 cy 135W.
 Originally designed to record pulse or sine-wave modulated signals received by AN-APR-1, AN/APR-2, AN-APR-4, AN/APR-5, BC-34B, S-27, SX-28. BRAND NEW.....\$147.50

SPRAGUE PULSE NETWORKS

7.5 E3-1-200-67P, 7.5 KV, "E" Circuit, 1 microsec.	200 PPS, 67 ohms Imped, 3 sections.....	\$4.30
7.5 E3-3-200-67P, 7.5 KV, "E" Circuit, 3 microsec.	200 PPS, 67 ohms Imped, 3 sections.....	\$6.75
7.5 E4-16-60-67P, 7.5 KV, "E" Circuit, 4 sections.	16 microsec, 60 PPS, 67 ohms Imped.....	\$8.25
15 E-91-400-50P, 15KV, "E" Circuit, 91 microsec.	400 PPS, 50 ohms Imped, 4 sections.....	\$12.00
15-A-1-400-50P, 15KV, "A" Circuit, 1 microsec.	400 PPS, 50 ohms Imped.....	\$37.5
15 E7-2-200-50P, 15KV "E" Circuit, 2 microsec.	200 PPS, 50 ohms Imped, 7 sections.....	\$42.00

SYNCHROS

Size 1, 3, 5, 6, 7 and 8 generators, motors, control transformers, differential generators, and differential motors in stock.			
1F	6DG	X	C-78248
51B	6G	2J1F1	C-78249
5CT	21G	21G1	C-78410
5D	7G	21H1	C-78411
5DG	A	C-44968-6	C-78415
5F			

A LEADING SUPPLIER OF ELECTRONIC & AIRCRAFT EQUIPMENT

**IMMEDIATE
DELIVERY -- FULLY
GUARANTEED**

A C MOTORS

5071930 DELCO, 115 V., 60 Cy., 7000 RPM.
PRICE \$6.50 EA.
TELECHRON SYNCHRONOUS MOTOR, Type
B3, 110 V., 60 Cy., 4 W., 2 RPM.
PRICE \$5.00 EA.
TELECHRON SYNCHRONOUS MOTOR, Type
BC, 110 V., 60 Cy., 6 W., 60 RPM.
PRICE \$4.00 EA.
EASTERN AIR DEVICES, Type J33, Synchro-
nous, 115 V., 400 Cy., 3 ϕ , 8000 RPM.
PRICE \$15.00 EA.

HAYDON TIMING MOTORS
110 V., 60 CY.

TYPE 1600, 2.2 W., 4/5 RPM. PRICE \$3.00 EA.
TYPE 1600, 2.2 W., 1/240 RPM.
PRICE \$3.00 EA.
TYPE 1600, 2.3 W., 1 RPM. PRICE \$3.00 EA.
TYPE 1600, 2.2 W., 1-1/5 RPM.
PRICE \$3.00 EA.
TYPE 1600, 3.5 W., 1 RPM. With shift unit
automatic engaging and disengaging shaft.
PRICE \$3.75 EA.
TYPE 1600, 2.2 W., 1/60 RPM.
PRICE \$3.00 EA.

SERVO MOTORS

CK1, PIONEER, 2 ϕ , 400 Cy. PRICE \$10.00 EA.
CK2, PIONEER, 2 ϕ , 400 Cy. PRICE \$14.00 EA.
CK2, PIONEER, 2 ϕ , 400 Cy., with 40:1 reduc-
tion gear. PRICE \$15.50 EA.
10047-2-A, PIONEER, 2 ϕ , 400 Cy., with 40:1
reduction gear. PRICE \$10.00 EA.
MINNEAPOLIS HONEYWELL Type B, Part No.
G303AY, 115 V., 400 Cy., 2 ϕ , built-in re-
duction gear, 50 lbs. in torque.
PRICE \$10.00 EA.
MINNEAPOLIS HONEYWELL Amplifier Type
G403, 115 V., 400 Cy., Used with above
motor. PRICE \$10.00 EA, WITH TUBES

REMOTE INDICATING
COMPASSES
26 V., 400 CY.

PIONEER TYPE AN5730-2 Indicator and
AN5730-3 Transmitter.
PRICE \$40.00 PER SET
KOLLSMAN TYPE 680K-03 Indicator and 679-
01 Transmitter. PRICE \$15.00 PER SET

D C MOTORS

DELCO TYPE 5069625 Constant Speed, 27 V.
D.C., 120 RPM. PRICE \$15.00 EA.
JOHN OSTER TYPE C-28P-1, 27 V., 0.7 Amp.,
7,000 RPM, 1/100 H.P. PRICE \$5.00 EA.
JAEGER WATCH CO. TYPE 44K-2 Contactor
Motor, 3 to 4.5 V. Makes one contact per
second. PRICE \$2.50 EA.
GENERAL ELECTRIC TYPE 5BA10AJ52C, 27 V.,
0.65 Amp., 14 oz. in torque, 145 RPM.
PRICE \$6.50 EA.
GENERAL ELECTRIC TYPE 5BA10AJ37, 27 V.,
0.5 amps., 8 oz. in. torque, 250 RPM.
PRICE \$6.50 EA.
GENERAL ELECTRIC TYPE 5BA10AJ18D, 27 V.,
0.7 Amps., 110 RPM, 1 oz. ft. torque.
PRICE \$6.50 EA.
BARBER-COLMAN CONTROL MOTOR, Type
AYLC 5091, 27 V., 0.7 Amps., 1 RPM. Con-
tains 2 adj. limit switches. 500 in. lbs.
torque. PRICE \$6.50 EA.
WHITE RODGERS ELECTRIC CO., Type 6905
No. 3, 12 V., 1.3 Amps., 1 1/2 RPM, torque
75 in. lbs. PRICE \$10.50 EA.

RECTIFIER POWER SUPPLY

GENERAL ELECTRIC TYPE 6RC146. Input 230
V., 60 Cy., 3 ϕ , adjustable input taps. Out-
put 130 Amps., at 28 V. D.C. Continuous
duty. Size 46" high, 28" wide and 17.5"
deep. PRICE \$225.00 EA.

INVERTERS

WINCHARGER CORP. PU-16/AP, MG750.
Input 24 V. D.C., 60 Amps. Output 115
V., 400 Cy., 1 ϕ , 6.5 Amps.
PRICE \$75.00 EA.
HOLTZER CABOT TYPE 149 H, Input 24 V.
D.C. at 44 Amps., Output 26 V. at 250 V.A.,
400 Cy., and 115 V., 400 Cy., at 500 V.A.,
1 ϕ . PRICE \$55.00 EA.
HOLTZER CABOT TYPE 149F, Input 24 V. D.C.
at 36 Amps., Output 26 V. at 250 V.A., 400
Cy., and 115 V., 400 Cy., at 500 V.A., 1 ϕ .
PRICE \$55.00 EA.
PIONEER TYPE 12117. Input 12 V. D.C., Out-
put 26 V., 400 Cy. at 6 V.A.
PRICE \$30.00 EA.
PIONEER TYPE 12117. Input 24 V. D.C., Out-
put 26 V., 400 Cy. at 6 V.A.
PRICE \$30.00 EA.
PIONEER TYPE 12116-2-A. Input 24 V. D.C.
at 5 Amps. Output 115 V., 400 Cy., 1 ϕ
at 45 watts. PRICE \$100.00 EA.
GENERAL ELECTRIC TYPE 5D21N3JA. Input
24 V. D.C. at 35 Amps. Output 115 V., 400
Cy., 485 V.A., 1 ϕ . PRICE \$25.00 EA.
LELAND PE 218. Input 24 V. D.C. at 90 Amps.
Output 115 V., 400 Cy., 1 ϕ at 1.5 K.V.A.
PRICE \$47.50 EA.

PIONEER AUTOSYNS

TYPE AY1, 26 V., 400 Cy. PRICE \$8.50 EA.
TYPE AY5, 26 V., 400 Cy. PRICE \$8.50 EA.
TYPE AY14G, 26 V., 400 Cy. PRICE \$15.00 EA.
TYPE AY14D, 26 V., 400 Cy. PRICE \$15.00 EA.
TYPE AY54D, 26 V., 400 Cy. PRICE \$10.00 EA.
TYPE AY131D Precision Autosyn.
PRICE \$35.00 EA.

PIONEER AUTOSYN POSITION
INDICATORS & TRANSMITTERS

TYPE 5907-17. Dial graduated 0 to 360°, 26
V., 400 Cy. PRICE \$25.00 EA.
TYPE 6007-39. Dual Dial graduated 0 to 360°
26 V., 400 Cy. PRICE \$40.00 EA.
TYPE 4550-2-A Transmitter, 26 V., 400 Cy.,
2:1 gear ratio. PRICE \$20.00 EA.

VOLTAGE REGULATORS

LELAND ELECTRIC CO. TYPE B, Carbon Pile
type. Input 21 to 30 V. D.C. Regulated
output 18.25 at 5 amps. PRICE \$6.50 EA.
WESTERN ELECTRIC TRANSTAT VOLTAGE
REGULATOR Spec. No. V-122855, Load
K.V.A. 0.5. Input 115 V., 400 Cy. Output
adjustable from 92 to 115 V.
PRICE \$10.50 EA.

RATE OR TACHOMETER
GENERATORS

EASTERN AIR DEVICES J36A, .02 V. D.C. per
RPM. Max. speed 5000 RPM.
PRICE \$12.50 EA.
ELECTRIC INDICATOR CO. TYPE B68 Rotation
Indicator, 110 V., 60 Cy., 1 ϕ .
PRICE \$14.00 EA.
ELECTRIC INDICATOR CO. TYPE PM-1-M.
Same as Type B35, 2 V. D.C. per 100 RPM.
Max. speed 5000 RPM. PRICE \$14.00 EA.
GENERAL ELECTRIC TACHOMETER GENERA-
TOR TYPE AN5531-1. Variable frequency,
3 ϕ output. PRICE \$20.00 EA.
GENERAL ELECTRIC TACHOMETER GENERA-
TOR TYPE AN5531-2. Variable frequency,
3 ϕ output. PRICE \$25.00 EA.

ALL PRICES
F. O. B.
GREAT NECK
N. Y.

SYNCHROS

1F SPECIAL REPEATER, 115 V., 400 Cy.
PRICE \$15.00 EA.
2J1F3 GENERATOR, 115 V., 400 Cy.
PRICE \$5.50 EA.
2J1G1 CONTROL TRANSFORMER, 57.5/57.5
V., 400 Cy. PRICE \$3.50 EA.
2J1F1 GENERATOR, 115 V., 400 Cy.
PRICE \$4.00 EA.
5SDG DIFFERENTIAL GENERATOR, 90/90 V.,
400 Cy. PRICE \$20.00 EA.
5G GENERATOR, 115 V., 60 Cy.
PRICE \$50.00 EA.
W. E. KS-5950-L2 Size 5G, 115 V., 400 Cy.
PRICE \$10.00 EA.

D C ALNICO FIELD MOTORS

DIHL TYPE S.S. FD6-23, 27 V., 10,000 RPM.
PRICE \$6.50 EA.
DELCO TYPE 5069466, 27 V., 10,000 RPM.
PRICE \$15.00 EA.
DELCO TYPE 5069370, 27 V., 10,000 RPM.
PRICE \$15.00 EA.
DELCO TYPE 5072400, 27 V., 10,000 RPM.
PRICE \$10.00 EA.

BLOWER ASSEMBLIES

JOHN OSTER TYPE MX215/APG, 28 V. D.C.,
7,000 RPM, 1/100 H.P. PRICE \$8.50 EA.
WESTINGHOUSE TYPE FL, 115 V., 400 Cy.,
6,700 RPM, Airflow 17 C.F.M.
PRICE \$7.50 EA.
DELCO TYPE 5068571 Motor and Blower As-
sembly, P.M. Motor, 27 V., 10,000 RPM.
PRICE \$15.00 EA.

GENERAL ELECTRIC
D C SELSYNS

8TJ9-PAB, TRANSMITTER, 24 V.
PRICE \$4.00 EA.
8DJ11-PCY, INDICATOR, 24 V. Dial marked
-10° to +65°. PRICE \$6.00 EA.
8DJ11-PCY, INDICATOR, 24 V. Dial marked
0 to 360°. PRICE \$7.50 EA.

MISCELLANEOUS

SPERRY A5 AMPLIFIER RACK, Part No.
644890. PRICE \$20.00 EA.
SPERRY A5 CONTROL UNIT, Part No. 644836.
PRICE \$7.50 EA.
SPERRY A5 AZIMUTH FOLLOW-UP AMPLI-
FIER, Part No. 656030, with tubes.
PRICE \$5.50 EA.
SPERRY A5 DIRECTIONAL GYRO, Part No.
656029, 115 V., 400 Cy., 3 ϕ .
PRICE \$25.00 EA.
PIONEER TYPE 12800-1 GYRO SERVO UNIT,
115 V., 400 Cy., 3 ϕ . PRICE \$20.00 EA.
ALLEN CALCULATOR TYPE C1 TURN & BANK
INDICATOR, Part No. 21500 28 V. D.C.
PRICE \$15.00 EA.
TYPE C1 AUTO-PILOT FORMATION STICK,
Part No. G1080A3. PRICE \$15.00 EA.
PIONEER GYRO FLUX GATE AMPLIFIER Type
12076-1-A, 115 V., 400 Cy.
PRICE \$40.00 EA.

**INSTRUMENT
ASSOCIATES**

363 GREAT NECK ROAD, GREAT NECK, N. Y.
Telephone Great Neck 4-1147

Write for Catalog NE100

U. S. Export License-2140

Western Union address:
WUX Great Neck, N. Y.

NEW YORK'S RADIO TUBE EXCHANGE

TYPE	PRICE	TYPE	PRICE	TYPE	PRICE	TYPE	PRICE	TYPE	PRICE	TYPE	PRICE
OA2	\$2.00	2J32	69.95	5CP1	4.95	323A	25.00	724A	4.95	876	.90
OA3	1.50	2J36	105.00	5CP7A	15.00	327A	3.95	724B	6.95	878	1.95
OA4G	1.35	2J38	17.95	5D21	27.50	350A	7.95	725A	9.95	884	1.95
OB2	3.00	2J42	150.00	5JP1	27.50	350B	5.95	726A	6.95	885	1.75
OC3	1.75	2J49	109.00	5JP2	17.50	357A	27.50	726B	56.00	889R	199.50
OD3	1.50	2J50	69.50	5JP4	27.50	368AS	6.95	726C	69.00	913	12.95
C1A	4.95	2J61	75.00	5LP1	18.95	371B	1.95	728AY	27.00	914	75.00
C1B	6.95	2J62	75.00	5LP1A	19.50	385A	4.95	730A	28.95	931A	6.95
1B21A	2.75	2K25	47.50	5R4WGY	3.75	388A	2.95	801A	1.00	954	.35
1B22	3.95	2K28	37.50	6C21	29.50	393A	8.95	802	4.25	955	.55
1B23	9.95	2K29	27.50	C6A	3.95	394A	8.95	803	5.95	956	.69
1B24	17.95	2K41	99.00	C6J	7.95	MX408U	.75	804	13.50	957	.29
1B26	2.95	2K45	199.50	7BP7	7.95	417A	17.95	805	5.95	958A	.69
1B27	19.50	2V3G	2.10	7DP4	10.00	434A	17.95	806	25.00	959	.69
1B32	4.10	3B24	5.50	12AP4	55.00	446A	1.95	807	1.69	975A	17.95
1B38	33.00	EL3C	5.95	15E	2.95	450TH	45.00	808	3.50	991	.45
1B42	19.95	3C24	1.95	15R	.95	450TL	45.00	809	2.45	E1148	.29
1B56	49.95	3C31	5.95	NE16	.45	464A	9.95	810	11.00	1280	1.95
1B60	69.95	3C45	13.95	FG17	6.95	471A	2.75	811	3.15	1611	1.95
1N21	1.35	3DP1A	10.95	RX21	3.95	527	15.00	813	8.95	1613	1.38
1N21A	1.75	3E29	15.50	35T	4.95	WL530	22.50	814	3.95	1616	2.95
1N21B	4.25	SN4	5.50	45 Special	.35	WL531	12.50	815	4.50	1619	.89
1N22	1.75	4A1	1.75	RK39	2.95	700A/D	25.00	816	1.45	1620	5.95
1N23	2.00	4B25	6.95	VT52	.35	701A	7.50	829	9.95	1622	2.75
1N23A	3.75	4C27	25.00	RK72	1.95	703A	6.95	829A	11.95	1624	2.00
1N23B	6.75	4C28	35.00	RK73	1.95	705A	3.95	829B	15.95	1625	.45
1N27	5.00	4E27	17.50	100TH	9.00	706AY	48.50	830B	11.50	1629	.69
1N48	1.00	4J25	199.00	FG105	19.00	706CY	48.50	832	5.95	1851	1.85
1S21	6.95	4J26	199.00	F123A	8.95	706A	17.95	832A	9.95	2050	1.85
2B22	4.95	4J27	199.00	203A	8.95	707B	27.00	833A	49.95	2051	1.80
2B26	3.75	4J30	395.00	211	.75	714AY	5.95	834	7.95	8012	4.25
2C34	.35	4J31	99.00	217C	18.00	715A	7.95	836	4.95	8013	2.95
2C39	32.00	4J32	99.00	242C	10.00	715B	15.00	837	2.95	8013A	5.95
2C40	27.00	4J33	99.00	249C	4.95	715C	25.00	838	4.95	8014A	29.95
2C43	27.00	4J37	99.00	250TL	19.95	717A	1.75	845	5.59	8020	3.50
2C44	.90	4J38	89.00	274B	3.00	718AY EY	48.50	849	52.50	8025	6.95
2D21	1.75	4J39	99.00	304TH	15.00	719A	29.50	851	80.50	9001	1.75
2E22	3.75	4J41	99.00	304TL	14.50	720A/B/C/D/Y	96.00	860	4.95	9002	1.50
2E30	2.75	4J52	350.00	307A	4.95	721A	3.95	861	39.50	9003	1.75
2J26	27.75	C5B	2.95	310A	7.95	722A	3.95	866A	1.79	9004	.75
2J27	29.95	5BP1	4.95	311A	7.95	723A/B	24.95	869B	37.50	9005	1.90
2J31	29.95	5BP4	4.95	312A	3.95			872A	3.95	9006	.35

This Month's Special 4C28 \$35.00 OTHERS

ATTENTION PURCHASING AGENTS AND BUSINESS MANAGERS

WE PURCHASE COMPLETE INVENTORIES AND ELECTRONIC PARTS AND TUBES FOR CASH.
CAN WE HELP YOU TO OBTAIN URGENTLY NEEDED ELECTRONIC MATERIALS?
OUR ORGANIZATION IS DEDICATED TO SERVE THE ELECTRONIC FIELD.

YOU CAN REACH US ON TWX NY1-3235

TEST EQUIPMENT

ATTENTION PURCHASING AGENTS AND BUSINESS MANAGERS

WE BUY—WE SELL—WE EXCHANGE—WILL PAY CASH FOR YOUR INVENTORY NO MATTER HOW SMALL OR LARGE. —TURN YOUR OVERSTOCKED ITEMS INTO CIRCULATION

Test Equipment

Microwave K Band 24,000 MC

TSKI-SE Spectrum Analyzer
K Band Flap Attenuator

X Band 10,000 MC

TS 12 Unit 1 USWR Measuring Amplifier, 2 channel
TS 12 Unit 2 Plumbing for above
TS 83 X Band Power and Frequency Meter
TS 35 X Band Pulsed Signal Generator
TS 36 X Band Power Meter
TS 45 Band Signal Generator
TS 146 X Band Signal Generator
TS 263 Navy Version of TS 146
TS 62, TS 102, TS 168
X Band Magic T Plumbing
X Band Tunable Crystal Mounts
TVN #3EV Bridge, Cy 94

S Band 3000 MC

TS 102, TS 270
TS 125, TS 155, TS 127
RF 4 Electrically Tuned S Band Echo Box
BC 1277/60ABQ S Band Pulsed Signal Generator
PE 102 High Power S Band Signal Generator

L Band

Hazeltine 1030 Signal Generator 145 to 235 Megacycles
Measurements Corp. type 84 Standard Signal Generator
TS 47, 40 to 400 MC Signal Generator
TS 226, AN/UPMI

Audio Frequencies

RCA Audio Chanalyst

Broadcast Wave Bands

162C Rider Chanalyst
Short Wave Adapter for 162C
TS 174 Signal Generator

Oscilloscopes

TS 239A Lavoie
BC 1287A used
in LZ sets
Supreme 564
APA10, APA28
TS 34 Oscilloscopes WE
TS 126

Other Test Equipment and Meters

TS 15/A Magnet Flux Meter
General Radio V T Voltmeter 728A
Calibrator WE 1-147
General Radio 1000 cycles type 213
Limit Bridges
Boonton Standard instructions
Model 40 Pyrometer
Rawson, meters 0-10 Microampere 0-2 Millivolt

RADAR Sets & Parts

APS 3—APS 4—R-111/APR5A

Minimum Order \$25.00

Prices Subject To Change



PHONE WORTH 4-8262

135 LIBERTY ST., NEW YORK 6, N.Y.

BRAND NEW - GUARANTEED - SURPLUS - METERS !!

D. C. MICROAMMETERS

100 Microamperes, Weston 643, 4 1/2" round flush bakelite case (red line at 99)..... @ \$21.00
 500 Microamperes, General Electric DO-53, 3" square flush bakelite scale calibrated 0-15 Kilovolts D.C. @ \$5.95

D. C. AMMETERS

1 Amp, Westinghouse NX-35, 3 1/2" round flush bakelite case (JAN type MR34W001DCMA) @ \$6.00
 1 Amp, General Electric DO-41, 3 1/2" round flush bakelite case CG-22000 @ \$5.50
 5 Amps, General Electric DO-41, 3 1/2" round flush bakelite case @ \$5.95
 10 Amps, General Electric DO-41, 3 1/2" round flush bakelite case @ \$5.95
 30 Amps, General Electric DW-51, 2 1/2" round flush bake case (JAN type MR24W030DCAA) @ \$4.50
 30-0-30 amps, Beede, 2 1/2" round flush metal case @ \$3.00
 30-0-30 amps, General Electric DW-51, 2 1/2" round flush metal case @ \$3.50
 50-0-50 amps, General Electric DO-41, 3 1/2" round flush bakelite, black scale, with lum. markings @ \$5.50

D. C. VOLTMETERS

5/125 Volts, Dual Range, Weston 506, 2" round flush metal, ring clamp mounted (non-Flanged) approx. 135 ohms per volt, plus button for high range @ \$4.00
 30 Volts, Gruen 250M, 2 1/2" round flush metal case @ \$3.50
 30 Volts, General Electric DO-41, 3 1/2" round flush bakelite case, 100 ohms per volt @ \$5.95
 75 Volts, General Electric DO-41, 3 1/2" round flush bakelite case, 100 ohms per volt @ \$5.95
 150 Volts, General Electric DO-53, 3" square flush bake case @ \$7.50
 300 Volts, General Electric DO-41, 3 1/2" round flush bake case, 1000 ohms per volt @ \$9.00
 300 Volts, Sun 2A1580, 2 1/2" round flush bakelite case, 1000 ohms per volt JAN type MR25W300 DCVV @ \$7.00
 500 Volts, Westinghouse NX-35, 3 1/2" round flush bakelite case, 1000 ohms per volt, black scale @ \$9.50
 750 Volts, Westinghouse RX-35, 3" square flush bakelite case 1 MA movement, complete with external resistor @ \$8.95
 2 Kilovolts, General Electric DO-53, 3" square flush bakelite case, 1 MA movement complete with 1000 ohms per volt precision ferrule-type multiplier @ \$10.95

D. C. AMMETERS

120 Milliamps, Simpson 125, 3 1/2" round flush bakelite arbitrary linear scale calib. 0-10 with caption "Output Units," external thermocouple @ \$7.50

1.5 Amp, General Electric DW-52, 2 1/2" round flush metal black scale @ \$3.50
 2 Amps, Simpson 137, 2" square flush bakelite case, made for Collins Radio Company @ \$4.50
 2 Amps, Weston 425, 3 1/2" round flush bakelite case @ \$8.50
 2.5 Amps, Simpson 35, 3 1/2" round flush bakelite case @ \$5.50
 2.5 Amps, Westinghouse NT-35, 3 1/2" round flush bakelite case, Signal Corps IS-111 @ \$6.00
 2.5 Amps, McClintock MD 3001, 3 1/2" round flush bakelite case, Signal Corps IS-111 @ \$4.50
 3 Amps, Weston 425, 3 1/2" round flush bakelite case, with external thermocouple @ \$9.50
 3 Amps, Westinghouse NT-35, 3 1/2" round flush bakelite (JAN type MR35W003RFAA) @ \$6.00
 5 Amps, General Electric DO-44, 3 1/2" round flush bakelite case @ \$7.50
 5 Amps, General Electric DO-44, 3 1/2" round flush bakelite case with external thermocouple @ \$8.50
 8 Amps, Westinghouse RT-35, 3" square flush bakelite @ \$7.50
 8 Amps, Weston 425, 3" square flush bakelite case @ \$10.50

A. C. AMMETERS

100 Milliampers, Weston 476, 3 1/2" round flush bakelite case, 400 cycles @ \$7.50
 150 Milliampers, General Electric AO-22, 3 1/2" round flush bakelite case @ \$5.50
 60/120 amps, Dual Range, Burlington 32XC, 3 1/2" round flush bakelite case, 5 amp movement, external current transformer @ \$7.50
 150 amps, Multirange, Westinghouse NA-35, 3 1/2" round flush bakelite case, with current transformer @ \$8.50

A. C. VOLTMETERS

8 Volts, Weston 476, 3 1/2" round flush bakelite case @ \$4.95
 15 Volts, Westinghouse NA-35, 3 1/2" round flush bakelite case (JAN MR35W015ACVV) @ \$5.50
 75 Volts, Weston 517, 2" round flush metal case, ring-clamp type mounting, non-flanged @ \$2.95
 300 Volts, Burlington 22A, 2 1/2" round flush metal case @ \$6.00

D. C. MILLIAMMETERS

1 Milliamp, General Electric DO-41, 3 1/2" round flush bakelite case (JAN type MR34W001DCMA) @ \$7.50
 1 Milliamp, Westinghouse NX-35, 3 1/2" round flush bakelite case, (JAN type MR35W001DCMA) approx. 53.7 ohms resistance @ \$7.50
 2 Milliamps, Westinghouse NX-35, 3 1/2" round flush bakelite case, (JAN MR35W002DCMA) @ \$5.50
 3 Milliamps, Gruen GV-587, 2 1/2" round flush bakelite case, scale calibrated 30 and 450 MA and 3000 volts @ \$3.50

5-0-5 Milliamps, Western Electric D-165647, 3 1/2" round flush bakelite case, concentric style movement approx. 160° deflection, scale calib. @ \$4.00
 15 Milliamps, Simpson 26, 3 1/2" round flush bakelite case (JAN type MR25W015DCMA) @ \$6.00
 20 Milliamps, General Electric DO-53, 3" square flush bakelite case @ \$5.50
 100 Milliamps, Weston 301, 3 1/2" round flush bakelite case @ \$7.50
 150 Milliamps, Triplet, 2" square flush bakelite case, black scale @ \$3.95
 150 Milliamps, Gruen 508, 2 1/2" round flush bakelite case @ \$3.95
 200 Milliamps, Marion, 3 1/2" round flush bakelite case, Knife edge pointer @ \$4.00
 200 Milliamps, Simpson 26, 3 1/2" round flush bakelite case (JAN type MR35W200DCMA) @ \$5.95
 300 Milliamps, General Electric DW-51, 2 1/2" round flush bakelite case (no Caption) @ \$0.00
 400 Milliamps, Triplet 321-T, 3 1/2" round flush bake case, made for Garfield Med. App. Co. @ \$4.50
 500 Milliamps, Dejur Amsco 312, 3" square flush bakelite @ \$5.00
 800 Milliamps, Dejur Amsco 310, 3" round flush bakelite case, Signal Corps Stock #3F980 @ \$4.50
 1000 Milliamps, Western Electric, Type D-55049, 3 1/2" round flush bakelite case, concentric style movement, with 100° scale length @ \$4.00

SPECIAL METERS

Hour Meter, JBT 31-EX, Indicates to 9,999.9 hours, 110-125 volts, 60 cycles, 3" round flush bakelite case @ \$14.50
 Rectifier type, 300 Volts AC, Weston 732, 3" rectangular flush bakelite case, 1000 ohms per volt @ \$11.00
 Decibel Meter, High Speed Type, Multirange, Weston 301, type 61, -10 to +6 DB, 6 MW in 600 ohms; ODB equals 1.9 volt 5000 ohms resistance. High speed type, 29 to 35 seconds to find reading. Only 2-6% overthrow, 16-50 Damping factor. L. P. #37.50. Complete with 3 external wire wound, @ \$11.50
 Rectifier type, Milliammeter, Weston 545, type 81, 270° movement 4" Aircraft type case, full sc, is 1.1 MA A.C. @ \$6.50
 Zero center DC Milliammeter 1-0-1 DCMA movement, Weston Model 502, 3" square flush metal black scale calibrated 900-0-900 R.P.M. @ \$18.00
 S Meter, Simpson 25, 3 1/2" round flush bakelite case, 5 MA zero right movement. Caption "D B Above 1 Microvolt" with translucent scale and internal lamp for illumination @ \$4.50
 Frequency Meter 350-450 cycles, Weston 637, 4" square, Aircraft type, 4 hole mounting 115 volt, Electro-dynamometer type @ \$7.50

We specialize in electrical Instruments. Over 75,000 meters in stock. Send for our latest circular showing our complete line of Surplus-New-Guaranteed meters.

MARITIME SWITCHBOARD
 338 Canal St., N. Y. 13, N. Y.
 Worth 4-8217

Orders accepted from rated concerns, public institutions and agencies on open account, others please send 25% deposit, balance C.O.D. or check with order. All prices FOB our warehouse, N.Y.C.



MARKTIME 5 HOUR SWITCH

A 10 amp. timing device. Pointer moves back to zero after time elapses. Ideal for shutting off radios and TV sets when you go to bed. Limited supply at this special PRICE... **\$4.90**

Also available in 15 min.-30 min.-1 hr. at \$5.90

Steven-Arnold Resonant Relay. Only two types in stock. 442 and 240 CPS either one... **\$4.50**
 Both for \$8.00

ALNICO **LUCKY** **17% COBALT**
 PURCHASE ENABLES US TO OFFER YOU THESE *Actual*
MAGNETS
39¢ EACH **3 FOR \$1.00**

ISOLATION TRANSFORMER \$1.95
 Nat. known Mfrs. 50 watt 2 windings, 115 V. to 115 V. 60 cy. Ideal to prevent shocks from small radios and medical and electronic devices.

ELAPSED TIME METERS
\$15.50



GONIOMETERS
 Micro Switch
 Solenoids
 Relays
 Electric Counters

EST. 1923 **BLAN** EST. 1923
 64 Dey St., New York 7, N. Y.

Genuine TELECHRON Motors

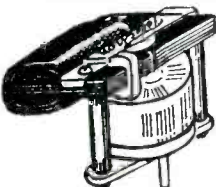

2 RPM \$2.90
 3.6 RPM 3.15
 1 RPM 3.95
 60 RPM 4.30
 One of Each \$12.00

CH 4 pole 35 ampere 115v. AC relay. **\$4.90**
 GE 3 ampere Mercury Switch 1/2" glass tube... 3 for **\$2.50**



ANNUNCIATOR DROP
 250 ohms, will drop on 12 volts or more
\$1.00

8 CONDUCTOR CO.—139 CABLE
 shielded or unshielded
 2 No. 14 and 6 No. 20. Write for samples

HOLTZER-CABOT M.G. 218. CONVERTER
400 CYCLE 110V A.C. 1 AMP MOTOR \$49.50
 1/4 H.P. D.C., 110V MOTOR

WESTON Model 528
3 Amp. and 15 Amp. A.C.
 With test leads in a leather case.
 Made for U. S. Army for Refrig. **\$18.75**
 Motor Testing

1951 TV Remote Control Motor Unit
 Ready to attach to any device that needs turning from remote point. A complete \$30.00 unit made by one of the greatest Video Companies. Sorry, can't name it here!
\$13.95

LINK TRAINER: ANT 18. Crated Shpg Wt. 2500 lbs. \$375.00
W-110-B Field Telephone Wire—1 mile metal reels—164 lbs. \$13.50
BC 797 VHF Tower Xmtr (superseded BC 610) Clean & complete. \$495.00
TS 174/UP Freq Meter 20-250 mc w/Xtal & Calib book \$245.00
TRANSFORMER, Supply, 1 Phase, 60 cy, 400 volts input, output 6/4.5/3 volts, 2 KVA, G.E. Spirakore Type HS, Form EIR, DL-8302909-G-1 new, crated 500 lbs. (only 12 of these available—several other types in stock) \$195.00
TUBE SOCKETS for KC4 rectifier with insulator—new \$15.00
BC 788A or AM less tubes \$19.95
VOLTAGE REGULATOR, Electronic, G.E. Model 3GVD14B3-new, less 8 tubes, input 110 v. 60 cy: output adjustable \$18.50
DUMONT MODEL 224 OSCILLOSCOPE, tested \$150.00
PE 103 Dynamotor with cables and plugs \$17.50
BC 455 Command receivers, 6-9.1 mc, less dynamotor \$9.50
DM 32 DYNAMOTOR for above \$3.95
PE 73 Dynamotor for BC 375. new \$17.50, used \$9.95
PE 75—2.5 KVA 115 v. Generator, Briggs & Stratton engine \$245.00
APS 4 RADAR, complete less dynamotor. \$450.00
SF 1 RADAR, complete with motor generator and 100 ft. waveguide. \$900.00
5BP1 Cathode ray tubes, new \$4.25
12DP7 Cathode ray tubes, new \$17.50

Large Stock of Aircraft, Shipboard & Mobile Radio, Radar & Electronic Equipment. Send Us Your Requirements. Large Stock of Tubes. No small parts.

JULY SPECIAL

RHEOSTAT, 100 watts, 2 ohm new \$1.95
 Lots of 1000 \$1.45 (units are enclosed)
 All prices good for July only. Terms: Payment in advance, or 25% deposit with COD orders. Large orders shipped truck freight. Order Notify. Subject to prior sale-FOB Jacksonville or southeast. Weights approximate.

EAST COAST RADIO CO.
 Rt. 2, Box 215B, JACKSONVILLE 8, FLA.
 Phone 3-0410

WHOLESALE ONLY

ELECTRONIC COMPONENTS AIRCRAFT EQUIPMENT HYDRAULICS

RADIO & ELECTRONIC SURPLUS
 13933-9 Brush St. Detroit 3, Mich.
 Phone Townsend 9-3403

RECTIFIER POWER SUPPLY

McCoplin Christie Model MH 24-25, input 230 v 60 cy. 3 ph. Output 25 amps. 24-28 v DC. Continuous duty, fan cooled. 13" x 13" x 19". Price \$75.00 each net. New. \$215.00 value.

LEO SAGAL CO.
 860 Glenmont, L. A. 24, Calif.

"Since radio began"  has been identified with

HIGH QUALITY

LOW PRICES

IMMEDIATE DELIVERY

WE WANT TO BUY FOR CASH

Any Quantity—New or Used

- EQUIPMENT—test equipment—meters—bridges—oscillators—etc.
- TELEVISION—sets—front ends—packs—strips—etc.
- RADIOS—record players—intercoms—cabinets—etc.
- ACCESSORIES—changers—motors—irons—phones—microphones—etc.
- COMPONENT PARTS—resistors—condensers—hardware—etc.
- TUBES—all types—receiving—transmitting—radar—etc.
- AMPLIFIERS & RECORDERS—all types—tape, wire, and disc.
- BATTERIES—all types—dry—wet—etc.

also

ALL TYPES OF GOVERNMENT SURPLUS

{ *All Inquiries and Offers Held in Strict Confidence*
All Deals Processed Strictly According to Agreement **}**

WHAT HAVE YOU? WHAT DO YOU NEED?

Wire—Write—Phone—BArclay 7-3588—Mr. Marino—Mr. Tanza—Mr. Eisen—Mr. Bender

MARINO RADIO CO.

Television, Radio and Electronic  *Supplies*

203 GREENWICH STREET (Near Fulton St.) NEW YORK 7, N. Y.

BArclay 7-3588



COMPASS COMMUNICATIONS CO.

393 GREENWICH STREET
BEckman 3-6510

NEW YORK 13, N. Y.
CABLE ADDRESS: COMPRADIO

We stock

- **RADAR**
Marine, Ground & Airborne
- **SONAR**
- **TRANSMITTERS**
from 25 watts to 5 kilowatts
- **RECEIVERS**
- **BEACONS**
- **LORAN**
- **RADIOTELEPHONES**
- **TEST EQUIPMENT**
- **TELEPHONE EQUIPMENT**
- **TUBES**
New, Standard Brands Only
—MAGNETRONS
—KLYSTRONS
—TRANSMITTING
and
Other Special
Purposes Tubes
- **MOTOR GENERATORS**
- **RECTIFIERS**
- **POWER SUPPLIES**

PORTABLE AND STATIONARY SWITCHBOARDS AND SUPPLIES

OUR EXPORT DEPARTMENT AVAILABLE FOR SPECIAL SERVICE TO OVERSEAS CUSTOMERS

WE MAINTAIN OUR OWN FULLY EQUIPPED TESTING LABORATORY IN THE SAME BUILDING AS OUR WAREHOUSE TO TEST ANY ITEM WE SELL.

We guarantee everything we sell



1/2 hr. timer 1/2 min. grads. rings buzzer at end of time interval — Telechron Motor & Micro Switch constr. 115V. A.C. 10 Amp. Cap. 10% "L, 5% "H., 3% "W. . . \$7.50 ea.

AMMETER, 150/300 dual range Triplet 341A 3 1/2" rectangular flush bakelite 5 amp Movement @ \$4.95 with external current transformer for 150 amp. **Only \$7.50**



DELCO BLOWER — sirocco type D.C. Flange diameter 3 1/4" blade 3-3/16" RPM @ 12 volts 3400 RPM @ 6 volts 1600 \$3.95



G. E. Model 6RS 5FB3 full wave 3 plate bridge (12 plates) maximum A.C. input 54 volts maximum D.C. output 40 volt D.C. current 0.150 \$1.15 ea.



SILVERPLATED REFLECTOR—Overall Dimensions 4 1/2", Reflecting Surface 4 1/4", Depth 1 1/2", Individually boxed 25¢ ea. \$20.00 per 100.



Miniature lamp T1 1/4, 3 volt .19 amp. Airplane Indicator, Amb. Ctd. 10 for \$1.00 100 for \$8.50

VOLTMETER Weston 833 130v. A.C. 400 cycles 2 1/4 flush bakelite Aircraft mounting black scale Fluorescent numerals removed from new equipment \$3.50

SEND FOR FREE BULLETIN



ALL PRICES F.O.B. N. Y. CITY

D.C. MICROAMMETERS

0-200 ua 3" sq. G.E. DO 50 \$ 9.00
0-100 ua 3" sq. G.E. DO 50 10.00
0-50 ua 3" sq. G.E. DO 50 12.00

PRECISION PORTABLE INSTRUMENTS

Single or multi-range

D.C. Microammeters, from 5 ua full scale. Thermo-couple Milliammeters, from 1.5 Ma. Thermo-couple voltmeters.

Precision Electrical Instrument Co.

146 Grand Street New York 13, N. Y.

FOR SALE:

GOOD USED STEM MACHINES

and other glass working equipment.

HAYDU BROTHERS
PLAINFIELD, NEW JERSEY

TEST EQUIPMENT

FOR SALE

Ferris, G.R., Measurements R.C.A., G.E., Boonton, etc. Lab disposing of duplicate and spare units. Clean condition. Immediate delivery.

Send for list.

FS-9924, Electronics

330 W. 42nd St., New York 18, N. Y.

SURPLUS COMPONENTS FOR SALE

Bathtubs, oils, micas, xformers, chokes, relays, trimmers, sockets, odd items, etc. Surplus lots purchased.

EMPIRE ELECTRONICS

Box 41, Midwood Stat., Brooklyn 30, N. Y. Phone BRyant 9-1220

FOR SALE

Beryllium Copper Strip .0062 (+ — .0005) x 5" x 60"

No. 1 — B & S Hard

700# Available

GLOBE TRADING COMPANY

1815 Franklin Street Detroit 7, Michigan

FOR SALE

one DAVEY PORTABLE BALANCING EQUIPMENT

model 2V with vibrometer for dynamic balancing of machine parts in the shop or in the field regardless of size or speed.

CUE FASTENER CORPORATION

225 Greenwich Ave., Stamford, Conn.

SEARCHLIGHT OPPORTUNITY ADVERTISING

- to help you get what you want.
- to help you sell what you no longer need.

Take advantage of it—For Every Business Want

"Think SEARCHLIGHT First"

REAL VALUES!

SCR 625 FAMOUS ARMY MINE-DETECTOR

for prospectors—miners—oil companies—plumbers—etc.—etc.—etc.

This unit is being offered now at a considerable reduction in price. Recently advertised at \$79.50 it is now available in the same brand new wrappings in suitcase style carrying case (less batteries) at

\$59.50

WHILE THEY LAST!



CABINET CH-118

Olive drab in color, this cabinet has a full length interlock access door on the rear. The front takes the standard 19" panels with 60 inches of height and 20 inches deep. It is shock mounted on a heavy steel platform and has a two-inch protrusion fully covering one side to accommodate wave trap and wiring. Louvered vents allow \$34.50 ea. air circulation top and bottom. F. O. B. Chicago

RA 52—RECTIFIER

A transtat controlled rectifier to produce high voltage DC from 110 VAC 60 cycle source. Up to 11,500 volts DC at 50 watts. Metered high voltage (0-15KV) and current (0-20 MA). **\$74.50**

BC 768

Radio Receiver Chassis Complete except for 13 tubes. This chassis with standard 19" panel front contains the receiver for 493.5 MC complete with power supply and an additional low voltage power supply that originally supplied the keyer BC 770 as described below. 110 VAC 60 cycles is the primary voltage.

Five 10 mfd-600 VDC oil filled GE condensers are used as filters. Five stages of 49 MC IF's. Two of 10.4 MC, 6.3 VAC Transformer and of course power transformers—chokes and miscellaneous parts. All units are in good condition as removed from new equipment. Even the salvage value is a great deal more than the low price of **\$9.95**

BC 770 KEYSER P/O RC 100 RADAR EQUIPMENT

This unit was used to pulse the transmitter BC 769 as described below. It is in a standard 19" panel chassis and contains many valuable parts such as a 10 Amp, 110 VAC 60 cycle circuit breaker, a 10 mfd 600 VDC oil condenser, a 6.3 Filament transformer, switches, pots, resistors and numerous others. Less tubes **\$4.95**

BC 769 TRANSMITTER

Originally designed to transmit RF pulses at 470 MC with the use of two 15E tubes. Power was supplied by RA 52 rectifier. Parts consist of 0-150 VAC 60 cycle meter, 6.3 VAC filament transformer, associated circuits for VHF transmission, standard 19" panel chassis, and a 15 Mfd-12000 VDC oil condenser. Less Tubes **\$6.95**

MISCELLANEOUS SPECIALS!

- | | | |
|--------------------------------------------------------------------------------------------------------------------------------------------------------|--------------|-------------|
| RA 10 DA Receiver..... | Used \$17.50 | New \$24.95 |
| RT7/APN1 Transceiver..... | | 14.95 |
| BC 347 Interphone Amplifier..... | | 2.95 |
| BC 442 Less Condenser..... | Used \$1.49 | 1.95 |
| A15 13 UHF Antenna, Pair..... | | .98 |
| PL 8 Filter..... | | 2.95 |
| I-97 Bias Meter..... | Used \$3.95 | 4.95 |
| RL 42 Antenna Gearbox Motor and Reel..... | Used \$4.95 | \$7.50 |
| AN ARC-5 VHF Transmitter (T-23/ARC5) One Tube Interphone Amplifier—Small compact aluminum case fully enclosed 2 1/4" x 3 3/4" x 5 3/4". Less Tube..... | | .79 |
| 40 Amps Circuit Breaker..... | | .59 |
| 220 M.A. Circuit Breaker..... | | .59 |
| Collins VFO Dial—5 calibrated ham bands from 3.2 Mc to 32 Mc; complete with pointer, gears, logging dial and flywheel. Scale 6" on 8" plate..... | each | .95 |
| 20-27.9 Mc—fully shielded. New for 10 used in BC 603 receiver. Frequency range 20-27.9 Mc—fully shielded. New for 10 | | 1.95 |
| I82F Five Inch 360 degree compass indicator and Selsyn receiver..... | | 4.95 |
| A-81-2 Transmitters Selsyn for I82 indicator..... | | 2.45 |
| (Both I82F & Trans. Selsyn for \$7.00) | | |
| T 23/ARC5 Brand new Transmitter for VHF..... | | 29.95 |

CATHODE RAY TUBES

- | | | |
|-------------|-----------|-----------|
| 3FP7—\$1.95 | 5BP4—3.95 | 5GP1—3.95 |
| 4AP10—1.95 | 5FP7—1.95 | |

Shipments FOB warehouse. 20% Deposit on orders. Minimum order \$5.00. Illinois residents, add regular sales tax to remittance. Prices subject to change without notice.

ARROW SALES, Inc.
Dept. L6
1712-14 S. Michigan Ave., Chicago 16, Ill.
PHONE: HARRISON 7-9374

TEST EQUIPMENT

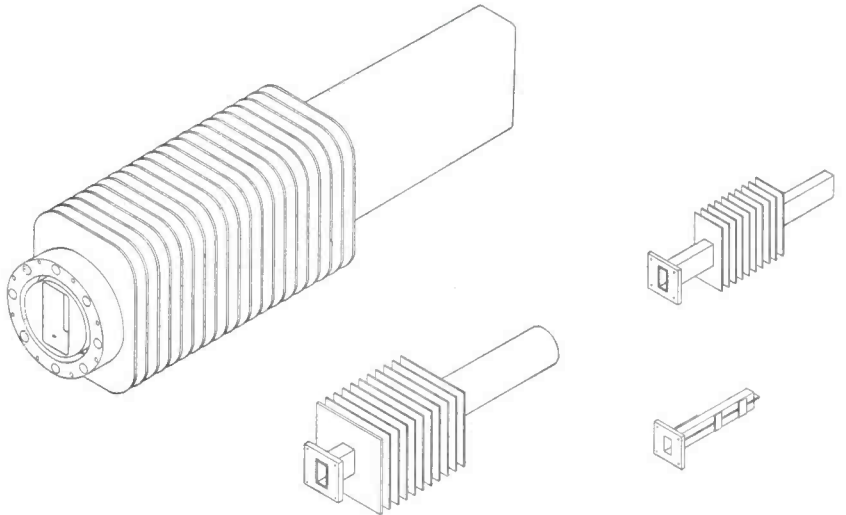

HI POWER X BAND TEST LOAD, dissipates 350 watts of average power for 3/8" x 1 1/4" waveguide, VSWR less than 1.15 bet. 7 and 10 KMC..... **\$150.00**

S Band Test Load TPS-55P/BT, 50 ohms **\$12.00**

HI POWER S BAND TEST LOAD, dissipates 1000 watts of average power, for 1 1/2" x 3" waveguide. Range 2500 to 3700 MC.

X Band Pick-up Horn, AT-48/UP with coaxial fitting **\$10.00**

TS-62 X Band Echo Box with r.f. cable and pick-up antenna.

TS-33 X Band Frequency Meter, 8500-9600 Mcs. Crystal detector and 50 micro-amp. meter. Indicates Resonance. Connection for scope available.

TS-45A-APM-3 Signal Generator, 8700-9500 mc., 110 V. 60-800 cps.

30 MC I.F. STRIP, VIDEO, and AUDIO AMPLIFIER AND 110-Volt 60-2600 cps POWER SUPPLY. Bandwidth 10 mc; new, part of SPR-2 Receiver.

AMPLIFIER STRIP AM-SSA/SPR-2 contains I.F. amplifier, detector, video amplifier, pulse stretcher and audio amplifier and Rectifier Power Unit PP-155A/SPR-2 bandwidth 10 mc, center frequency 30 mc, sensitivity 50 microvolts for 10 milliwatts output. Power supply 80/115 V ac, 60-2600 cps 1.3 amps. Send for schematic... **\$65.00** less tubes

S Band Signal Generator Cavity With Cut-Off Attenuator, 2300-2950 mc., 2C40 tube, with modulator chassis... **\$30.00**

UPN-1 S Band Beacon Receiver-Transmitter **\$75.00**

TS-155 S BAND SIGNAL GENERATOR and Power Meter.

S-Band Mixer, tunable by means of slider, type N connector for the R.F. and local oscillator input. U.H.F. connector for the I.F. output, variable oscillator injection. **\$30.00**

S Band Crystal Mixer, variable oscillator injection, illustrated **\$17.50**

TS-110 S Band Echo Box 2400-2700 mc. portable **\$110.00**

X Band Thermistor Mounts, VSWR less than 1.4 8500-9600 MC Fixed triple tuned, 1/2" x 1" waveguide... **\$40.00**
Fixed triple tuned 3/8" x 1 1/4" waveguide **\$50.00**

X Band Crystal Mount, 1/2"x1" waveguide **\$25.00**

UG80/U 1/2"x1" to 3/8"x1 1/4" adapter, **\$5.00**

ESTERLINE Angus recording Milliammeter 60 cycles, 110V. AC 1 ma full scale. **\$160.00**

TS-89 Voltage Divider for measuring high video pulses, ratios 1:10 and 1:100 transmission flat within 2 db 150 c.p.s. to 5 mc., with cable for attaching to synchroscope **\$30.00**

Waveguide Below Cut-off Attenuator L 101-A U.H.F. Connectors at each end calibration 30-100db **\$15.00**

HYPERSIL CORE CHOKE, 1 Henry, Westinghouse L-422031 or L 422-32... **\$3.00**

PULSE INPUT TRANSFORMER, permalloy core, 50 to 4000 kc., WE-161310, impedance ratio 120 to 2350 ohms... **\$3.00**

X Band attenuator, 1 1/4"x3/8" guide, single guillotine type, 0-30 db, V.S.W.R. 1.2 maximum, calibrated **\$85.00**

High Voltage motor operated switch, 18 KV., 5 Amps peak, Schweitzer-Conrad No. QA-35582 **\$50.00**

ELECTRO IMPULSE LABORATORY
62 White Street Red Bank 6-0404 Red Bank, N. J.

SURPLUS EQUIPMENT

ONAN MOTOR GENERATOR SET MG 075-G-1

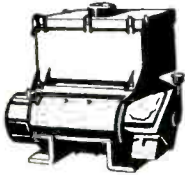

Generator: 115 VAC; 480 cycle; 5.3 Amps; 6KV; PF 1.0; Also 26 VDC; 100 watt; 3.8 Amps; Driven by 115-230 VAC 2hp motor; 60 cycles; single phase; 3450 rpm; 10.5 amps.

BRAND NEW
\$195.00

PIONEER AUTOSYNS

AY-1.....26 volt-400 cycle.....\$4.95
AY-5.....26 volt-400 cycle.....\$5.95
(Has hollow shaft)

SERVO MOTOR 10047-2-A-Pioneer; 2 Phase; 400 cyc; with 40:1 Reduction Gear. \$10.00 ea.

400 CYCLE MOTORS

AIRESEARCH, 115V, 400 Cps, Single Phase 6500 rpm, amp. 1.4, torque 4.6 in. oz. H.P. .03 \$10.00 ea.

RATE GENERATORS

J-36 DC Voltage Generators
Eastern Air Devices (Mfg.)

Like New.....\$10.00 ea.



KERMIN SYNCHRONOUS 4 RPM MOTOR

NEW.....\$2.95 ea.



INVERTERS

PE 218 LELAND ELECTRIC

Output: 115 VAC; single phase PF 90; 380/500 cycle; 1500 VA.
Input: 25-28 VDC; 92 amps; 8000 RPM; Exc. volts 27.5.

Brand New.....\$39.95 ea.

12116-2-A PIONEER

Output: 115 VAC; 400 cycle; single phase; 45 amp.
Input: 24 VDC; 5 amp.....\$90.00

12130-1-A PIONEER

Output: 115 VAC; Single phase; 400 cycle; Amps .88; 100 VA. Input: 18-28 VDC; 20 amps.
\$80.00 ea.

10486 LELAND ELECTRIC

Output: 115 VAC; 400 cycle; 3 phase; 175 VA; .80 PF. Input: 27.5 DC; 12.5 Amp; Cont. Duty.
\$90.00 ea.

5D2IN3A GENERAL ELECTRIC; Output: 115 VAC; KVA 485; PF 1; 400 cycle; single phase Input: 27 VDC; 35 Amps.....\$25.00 ea.

5AS131N3 GENERAL ELECTRIC (PE-118)

Output: 115V; 400 CYC; 1 ϕ at 1500 VA.; PF 0.8
W.E. Spec. KS-5601Ll. Input: 26 VDC at 100 Amps.....\$29.50 ea.

12130-1-B PIONEER

Output: 122.5 AC; Single phase; 400 cycle; 141 VA
Input: 20-30 VDC; Amps 12-18.....\$80.00 ea.

5AT121JJ2B GENERAL ELECTRIC

Output: 115 VAC; 400 cycle; 3 phase; 175 VA; 80
Output: 115VAC; 400 CYC; 750 VA; 3 Phase; and
26 VAC; 400 CYC; 250 VA; Single Phase; Input:
24VDC; 55 AMP.....\$95.00 ea.

10563 LELAND ELECTRIC

Output: 115 VAC; 400 cycle; 3-phase; 115 VA; 75
PF. Input: 28.5 VDC; 12 Amp.....\$80.00 ea.

SEND YOUR REQUEST FOR ALL TYPES OF SYNCHROS
PLEASE ENCLOSE FULL AMOUNT WITH ORDER
ALL PRICES F.O.B. PASADENA UNLESS OTHERWISE SPECIFIED
EQUIPMENT FULLY GUARANTEED.

C and H Sales Company

BOX 356-E EAST PASADENA STATION • PASADENA 8, CALIFORNIA

ATTENTION • ATTENTION • ATTENTION • ATTENTION •

BATHTUB AND CHANNEL TYPE OIL CAPACITORS

Prices within reason—let us quote on your needs

.01	.25-.25	all voltages & terminal layouts a v a i f a b l e—also channel types YAB-YAT-WAB-WAT** Special types. Low voltage bathtub cased electrolytics *****
.2	.25-.25-.25	All material clean & new, properly packaged. Production quantity available.
.05	.5	
.5-.05	.5-.5	
.05-.05-.05	.5-.5-.5	
.1	1.0	
.1-.1	1.0-1.0	
.1-.1-.1	2.0	
.25	4.0	

Same day service on receipt of P. O.

JULY SPECIAL • Power transformer 208 V 3 ph. pri.
Delta 3700 V/410 ma. sec. Y connected—a buy at \$49.50
ELECTRONIC SPECIALTY SUPPLY CO.
56 LISPENARD STREET BARCLAY 7-2684 NEW YORK 13, N. Y.

WESTINGHOUSE HIPERSIL CORES

OVER 20,000 UNITS IN SEVERAL DIMENSIONS. AVAILABLE FOR IMMEDIATE DELIVERY. SEND FOR LIST WITH COMPLETE DESCRIPTIONS.

RAYTHEON MFG. CO.

Surplus Sales Dept. Waltham, Mass.
Tel. Waltham 5-5860—Ext. 2

NEW ADDRESS

still the same best buys
New Mobile Power Units
w/Filters

DM21M 14v in 230v 90ma out \$8.50
BD77L 14v in 1050v 330ma out \$15.00
PE73 28v in 1050v 350ma out \$24.00
PE94C (for SCR522) 28v in \$15.00
PE98 (for SCR522) 14v in \$65.00
MP10G dual for TA2 ea \$75.00
PE86 24v in 230v 50ma out \$4.50

Shipped Rail Exp. or Freight Collect.

LONG ISLAND RADIO COMPANY
P. O. Box 474, Montrose, Penn.

NEW NEW NEW

Two Deck Ceramic Rotary Switches

- 1) 2 Ckt.-6 pos. Non-Shorting... .35 ea.
- 2) 4 Ckt.-4 pos. Shorting... .30 ea.

Wirewound Potentiometers & Rheostats Standard Brands

- 1) 10K ohm-2w\$25 ea.
- 2) 25K ohm-4w30 ea.
- 3) Dual 2K ohm-2w35 ea.
- 4) *20K ohm-4w20 ea.
- 5) *60 ohm-4w20 ea.
- 6) *20 ohm-4w20 ea.
- 7) *2 Meg.-2w Carbon..... .20 ea.
- 8) *350 ohm-25w40 ea.
- 9) *225 ohm-25w40 ea.

Above controls all have shafts 3/8" long

TRANSMITTING MICA CONDENSERS

- | | | |
|-----------------------|---|------------|
| F2 | H | A |
| .005 Mfd-5KV-F2 | | \$3.50 ea. |
| .001 Mfd-5KV-F2 | | 2.00 ea. |
| .001 Mfd-2,500V DCW-H | | .45 ea. |
| .003 Mfd-2,500V DCW-H | | .45 ea. |
| .01 Mfd-1250V DCW-H | | .45 ea. |
| .01 Mfd-1250V DCW-A | | .45 ea. |

WIREWOUND RESISTORS

- | | |
|-----------------------------|---------|
| 2K ohm-100 watt | .40 ea. |
| 10K ohm-50 watt | .35 ea. |
| 2X2 Tube Sockets (Low Loss) | .19 ea. |

TELEPHONE RELAYS

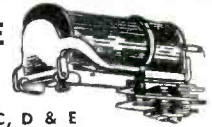

CLARE, TYPES C, D & E
COOKE, AUTOMATIC—ELECTRIC
ALL TYPES OF COILS and PILE-UPS
Send Us Your Specifications For Our Quote
SEND US YOUR NEEDS FOR OUR QUOTE

Chase

Electronic Supply Co.
222 Fulton St.
New York, 7, N. Y.
Phone—HOLLIS 4-5033

0A2	\$ 1.60	955	\$.40
0B2	1.65	9002	.90
1B27	18.50	9005	1.50
1L21 (GE)	5.00	CE25	.75
1N21	.80	100TH	9.50
1N21-B	3.00	250TH	18.50
1N23	1.00	304TH	13.95
1N23-B	4.00	304TL	13.95
1N34	.79	450TH	29.95
2D21	1.60	F-123-A	6.55
2E22	1.25	HK57-B	5.00
2E24	4.75	HK254	7.00
2E26	3.75	RK20-A	5.00
2E30	2.20	RK28-A	5.00
2J22	7.95	RK34	.27
2J26	5.00	RK38	19.95
2J32	29.50	RK47	5.00
2J36	85.00	RK59	.75
2J61	22.50	RK60	1.50
2K28	35.00	RK63	19.95
2K45 (WE)	150.00	RK67	24.95
3B25 (3 em. Klystron)	3.95	RK72	1.40
3DP1-A (RCA)	3.50	RK73	1.50
3J31	62.50	T-40	3.00
5D21	19.95	VR150	1.00
5JP1	22.50	OZ4/OZ1G	.65
10Y	.45	1A7GT	1.05
15E	1.50	1B3GT	1.25
35TG	3.50	1X2A	1.60
21T	.85	3S4	.87
300-B	7.00	5U4G	.90
371-B	.90	5V4G	1.10
374-A	7.00	5X4G	.90
707-A	10.95	6AH6	1.60
707-B	19.95	6AK5	1.35
715-A	6.50	6AL5	.90
715-B	12.95	6AU6GT	1.59
725-A	6.95	6BL7GT	1.59
809	2.25	6BY5G	1.65
811	2.35	6C4	.90
812	2.75	6F4	5.95
813	8.95	6J4	4.95
829	9.50	6J5GT	.50
829-B	13.50	6T8	1.50
832	5.95	12AT7	1.35
837	1.50	12AU7	1.10
851	55.00	12BH7	.70
866-A	1.00	25L6GT	1.95
872-A	2.95	35L6GT	1.25
892-R	200.00	35Z5	.85
		50L6GT	.85

Many others in stock—Write, Compare our Prices.
Write for Quantity Prices on Some Types.
Write for Details on Following:
G.R. Model 50-B Variacs (New).....\$100.00
BC-800—Radar Xmt. Revr..... 40.00
BC-611—Walkie-Talkies..... Pr. 150.00

BARRY ELECTRONICS CORP.

136 LIBERTY ST., N. Y. 6, N. Y.
Phone: RECTOR 2-2563

25% deposit with orders—or send full remittance to save COD charges—rated firms (D&B) N/10 Days.
All merchandise fully guaranteed

COLUMBIA ELECTRONICS LTD.

TELEVISION CAMERA

350 line resolution. Easily converted to present RMA standards. Circuits available with camera. Complete, like new.

TEST EQUIPMENT Complete Line!

SIGNAL GENERATOR 804-C
DUMONT 224-A OSCILLOSCOPE
I-77 HICKOK TUBE CHECKER
I-208 FM SIGNAL GENERATOR
RPC MODEL 644 MULTIMETER
FERRIS MICROVOLTAGE MOD. 18-C.

IE-36 (New)	TS-102A/AP
I-139 METER	TS-111/CP
I-212	TS-117/GP
TS-3/AP	TS-127/U
TS-5/AP	TS-155
TS-10B/APN	TS-170/ARN-5
TS-15A/AP	TS-182/UP
TS-19/APQ-5	TS-184A/AP
TS-34/AP	TS-250/APN
TS-36/AP	TS-268/U
TS-61/AP	TS-375/U
TS-100/AP	UPM-1(Complete)

RC-184 IFF EQUIPMENT
Brand New. Complete.

COMPLETE RADAR

APS-4 MARK 16
APS6

RECEIVERS

APR-4 APR-5

SCR-720 EQUIPMENT
SCR-584 PARTS

HEADSETS

HS-33 Brand New
PERMAFLUX DYNAMIC HEADSETS
4,000 Ohm. New.

MK-20A/UP — New,
INDIVIDUALLY BOXED

SCR-291 DIRECTION FINDING
EQUIPMENT—NEW

MP-22 MAST BASE U/16 U PLUGS
With Hardware and MG19A—New
Bracket. R5/ARN-7

SEE COLUMBIA ELECTRONICS AD
ON PAGE 309

COLUMBIA ELECTRONICS LTD.
524 S. San Pedro St., Los Angeles 13
CALIF.
Cable Address: COELECT
ALL ITEMS SUBJECT TO PRIOR SALE

BRAND NEW U. S. GOV'T. SURPLUS GUARANTEED

POWER RHEOSTATS



Ohms watt ea.	Ohms watt ea.	Ohms watt ea.	Ohms watt ea.		
5	25	1.98	225	50	2.53
5	50	2.81	250	50	2.23
5	150	5.93	250	50	2.53
1	50	2.81	300	60	2.53
2	50	2.81	300	100	4.27
2	100	4.68	350	25	1.98
2	225	6.59	350	100	4.26
2	300	8.42	370	25	1.98
3	100	4.67	378	150	6.59
3	225	6.58	400	25	1.98
3x3	300	29.95	400	75	3.90
4	225	6.60	500	25	1.98
5	25	1.97	500	75	3.95
5	100	4.68	500	50	2.53
6	25	2.23	500	100	4.39
6	75	3.90	500	150	6.48
6	75	2.53	585	150	6.49
8	50	2.53	500	25	2.23
10	25	2.23	750	150	5.95
10	100	4.27	1000	25	1.98
12	25	2.23	1000	150	5.93
12	50	2.53	1200	225	7.20
15	25	1.98	1250	50	2.66
15	75	3.90	1250	150	6.59
15	100	4.38	1500	25	2.53
20	50	2.53	1500	50	2.65
25	25	2.23	1800	150	6.24
50	25	1.98	2000	25	2.23
50	50	2.53	2000	50	2.53
60	25	1.98	2250	150	6.24
75	25	1.98	2500	150	6.24
75	75	3.90	2500	25	2.23
75	100	4.39	2500	50	2.53
80	50	2.53	2500	100	4.68
80	500	12.46	3000	25	2.39
100	25	1.98	3000	100	4.68
100	50	2.53	5000	25	2.53
100	100	4.39	5000	50	2.85
125	25	2.53	7500	50	2.85
150	50	2.53	7500	100	5.31
175	25	2.53	10000	50	3.17
185	25	1.98	10000	100	5.17
200	25	1.98	15000	25	3.29
200	100	4.27	20000	150	8.43

Specify whether shaft required for knob or screwdriver adjust.

OIL CONDENSERS



Mfd.	Volts	Avail.
1	3-6	20K
.25	2-3-31-4-5K	
.5	600-1-3K	
1	600-1-11-2-5-6	
2	400-600-1-11-2	
4	3-4K	
6	600-700-1-11K	
6	400-600-1-11-2K	
8	600	
10	600-21K	
15	600-1K	
30	90-vac. 3-ph	
100	250-vac. 3-ph	
3x4	600	
4x3	600	
4x8	600	
3x10	90-vac	

Special Prices on Request

BATHTUBS



Mfd.	Volts	Avail.
.033	400	
.05	2-4-800	
.1	4-8-1K	
.15	600	
.25	2-4-800	
.5	400	
.75	4-8-1K	
1	600	
2	1-2-4-8-1K	
4	4-600	
8	50-100	
25	50	
40	25-50-75	
50	25	
100	25	
200	12	
300	6	
2x.01	2-400	
2x.02	6-1500	
2x.045	600	
.046x.055	600	
.2x.05	6-1500	
.1x.05	200	
1x.5	400x50	
2x.1	4-600	
2x.16	600	
2x.2	600	
2x.25	4-600	
.3x.5	500	
2x.5	4-600	
1x.05	500	
1x.1	300	
1x.5	200	
2x1	600	
2x10	25	
2x200	9	
3x.001	9 600	
3x.05	600	
3x.1	4-600	
3x.25	4-600	
3x.5	100-600	
.01Ex.03x.045x.08x.12/600		

Specify whether shaft required for knob or screwdriver adjust.

SELECTOR SWITCHES

Pole	Pos.	Deck	Type	Each
1	11	1	Bak-n/ahgt	.60
1	21	3	Bak-n/ahgt	.89
2	2	1	Cer-ahgt	.50
2	6	2	Bak-n/ahgt	.60
2	11	2	Bak-ahgt	.75
3	4	2	Bak-n/ahgt	.58
3	5	2	Cer-n/ahgt	.98
6	11	6	Bak-n/ahgt	2.25
10	6	5	Cer-ahgt	2.25
16	2	4	Bak-n/ahgt	1.35

(Many other types in stock)

"AN" CONNECTORS



Large Variety Available At Great Savings

Send your specs and let us quote

BIRTCHEK TUBE CLAMPS

#	FROM	#	FROM
#926-A	926-B22	#926-B22	926-C
#926-A1	926-C	#926-C	926-C1
#926-A14	926-C1	#926-C1	926-C5
#926-B	926-C5	#926-C5	926-C10
#926-B1	926-C10	#926-C10	926-C24
#926-B7	926-C24		

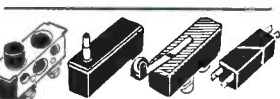

MICROSWITCHES

A. #Y2-RS13 SPST "S" plunger, metal housing, norm. op. .59
B. #B-RS10 SPDT type "S" plunger, 2-circuits: one op and one cl. .59
#WZ-RL8 (not illus.) SPST leaf actuator, norm. cl. .59
#R-RL2T (not illus.) SPST 10a 125 vac roller plunger, norm. closed .59
C.G.E. SWITCHETTE 10a/115voltsAC
#CR1070-C103A3 SPST closed .59
#CR1070-C103E3 SPST open .59
#CR1070-C103R3 SPST closed .59
#CR1070-C123C3 115V op/cl .59
(Many other types in stock)

SHOCKMOUNTS



100P-1	1 lb.	.15
100P-2	2 lb.	.15
100P-2	2 lb.	.15
100P-3	3 lb.	.15
100P-6	6 lb.	.20
150P-4	4 lb.	.20
150PH-8	8 lb.	.45
100PL-1	1 lb.	.15
150P-7	7 lb.	.25
150P-6	6 lb.	.35
200PD-15	15 lb.	.59
200PEN-35	35 lb.	.75
204P-112	112 lb.	.98

TERMINAL BOARDS



5 terminal	.98
8 terminal	1.67
12 terminal	2.49

HUNDREDS OF OTHER ITEMS AVAILABLE
Open a/c to Rated Concerns. Prices net FOB our whse NYS and subject to change without notice

POTENTIOMETERS

TYPE "JJ"	\$1.50	TYPE "JJJ"	\$4.95
ohms	ohms	ohms	ohms
50*	2500*	100K*	500-500*
65*	4000*	100K*	500-800*
200*	5000*	125K*	1500-1500*
300*	10K*	200K*	2000-2000*
400*	15K*	250K*	2000-50K*
500*	20K*	250K*	2200-24K*
600*	25K*	500K*	2000-2000*
750*	30K*	1meg*	25K-10K*
1000*	50K*	1meg*	35K-5000*
1500*	80K*	2meg*	50K-50K*
2000*		2meg*	100K-100K*
			4meg-4meg*

ohms ohms ohms ohms
130 K-130K*
150 K-150K*
250 K-250K*
350K-5K*
350K-25K*
300K-300K*
350K-350K*
800K-75K*
1meg-1meg*
2meg-2meg*
4meg-4meg*

TRANS-MITTING MICAS

mfd.	vw	type	ea.	mfd.	vw	type	ea.
.00001	600	4	.36	.00162	600	4	.42
.00003	600	4	.29	.002	600	4	.39
.00005	2500	9	.57	.002	1200	4	.72
.0001	600	4	.29	.0025	600	4	.39
.0001	2500	9	.57	.003	600	4	.43
.00015	600	4	.36	.004	1200	4	.45
.0002	600	4	.29	.005	1200	9	.99
.00025	600	4	.29	.0047	600	4	.47
.0005	600	4	.29	.005	2500	9	1.86
.0005	2500	4	.75	.006	600	4	.54
.0005	2500	9	.77	.01	600	4	.65
.0006	2500	9	.85	.01	9	1.41	
.0007	600	4	.36	.02	600	4	.92
.00075	600	4	.36	.02	1250	9	2.12
.0008	600	4	.36	.025	600	4	1.08
.0009	600	4	.36	.03	300	4	.99
.001	600	4	.36	.03	600	4	1.34
.001	1200	4	.54	.043	600	4	1.75
.001	1200	9	.57	.05	300	4	1.19

(Many other sizes in stock)

"UG" and "UHF" CONNECTORS

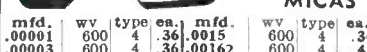

UG-9/U	UG-25/U	83-1AP
UG-10/U	UG-27/U	83-1RTY
UG-12/U	UG-28/U	83-1SP
UG-14/U	UG-57/U	83-1R
UG-15/U	UG-58/U	83-1D
UG-16/U	UG-88/U	83-1SPN
UG-18/U	UG-123/U	83-22R
UG-19/U	UG-185/U	CN 4912U
UG-20/U	UG-260/U	CN 4912A
UG-21/U	UG-290/U	CN 4915I
UG-21B/U	83-1AC	UG 87/U
UG-22/U	83-1F	
UG-24/U	83-1J	

PRICES ON REQUEST

Jones Connectors

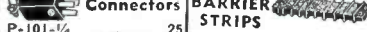

P-101-1/4	.25
P-101-3/8	.30
S-101-D-MOD	.33
S-102-AB	.13
S-304-CCT	.25
P-306-AB	.16
P-306-CCT-L	.33
S-306-FHT	.24
S-308-AB	.21
P-312-AB	.24
P-312-CCT-L	.42
P-315-FHT	.40
P-315-EB	.30
P-315-CCE	.40
S-315-AB	.36
S-318-AB	.74
P-324-FHT	.74
P-324-EB	.58
S-330-AB	.84
S-404-AB	.33
P-406-AB	.33
S-408-CCT	.58
S-408-CCT	.69
S-2408-SB	.53
P-2412-SB	.61
S-2412-CCE	.87
S-502-D	.97
P-308-CE	2.58
P-310-CE	3.04
P-512-CE	3.52
2-140-Y	.13
6-140-Y	.33
10-140-	

TELEMARINE

The Best in Electronic Surplus

SF-1 Radar Eqpts. 10 Centimeter, Brand New with complete spares to insure over 10 years of continuous operation. Includes motor-generator set in each, all wave-guide plumbing, instruction books, etc. 19 cases per set, export packing.
PRICE, EACH \$2,500.00
 Beachmaster, 250 watt Portable Sound Amplifier Systems, with nine speaker rack, tubes, mike, cables, and spares. Operation from 110 volts, one phase, 60 cycles AC. Excellent and New condition units.
PRICE, EACH \$185.00
 Case of spares for above. **PRICE** \$100.00
 Western Electric Model HLAS, 500 watt Sound Amplifier Systems, consisting of 40 watt Pre-Amplifier; 500 watt Power Amplifier with built-in power supply, expander-compressor circuit, internal blower-ventilation, 30 kc erasing oscillator circuit for magnetic tape recording, volume and meter controls; two speaker racks, each with 8-60 watt dynamic horn units. Operation from 115/230-3-60 AC. New. Unused. Complete with tubes, cables, connectors and instruction manual. **EACH** \$895.00
 Wilcox 36A Rectifiers, single cabinet unit containing 4 separate transformer rectifier power supplies, capable of supplying DC voltage to one or more 96C transmitters and one or more Wilcox 50A Modulators (which are designed to modulate a 96C 3 KW RF Output Transmitter. Has terminal connections for 5 96C Transmitters, and for local or remote operation. Measures: 72" high, 29 1/2" wide, and 24 1/2" deep. Operates from 220/3/60 AC. NEW eqpt., complete with control relays, tubes, power transformer (removed for shipment), instruction manual. **WRITE FOR PRICE.**

TS-47 / APR

Signal Generator. 40 to 115 mc and 115 to 500 megacycles, butterfly condenser tuning with direct precision calibration. Solid construction and shielding, with built-in power supply which operates from 80 to 220 volts AC, 50 to 2600 CPS. Complete with instruction sheets, tubes, and connectors. **NEW and like new units. EACH** \$140.00

BC-348 Receivers, like **NEW** condition, complete with tubes and dynamotor. **EACH** \$140.00

BC-221 Frequency Meters. Excellent to **LIKE NEW** condition, with calibrated charts, tubes and crystal. **EACH** \$85.00

TCS, Ship Radio Transmitter-Receiver, for 12/24/115/230 V., D.C., and 115 V. AC Power Supplies, all available. Also TCS spares, new, export wrapped. Radio telephone and radiotelegraph at 20 & 40 watt, 1.5 to 14.0 mc. Complete with all accessories. Excellent condition. **EACH** \$500.00 up.
 RCA Models ET-4332-B, and ET-4336 Radiotelephone Transmitters, 250 Watts output. Freq. 2.0 to 20.0 mc, front-panel band switching—no plug-in coils, crystal or VFO. Uses 4-306, 2-505, 2-813, and 1-307. Dim: 57"x17"x24" deep. Excellent Condition units. Separate Speech Amplifiers, to match, also available. **Transmitter, EACH** \$185.00
 AN/CRT-1A Sonobuoy Transmitters, for mine and submarine detection. With parachute, tubes, etc., ready for operation (except standard types dry batteries). Operates at 87.7 mc. Excellent to **NEW** condition. **PRICE EACH** \$55.00 and up.
 Sound-Powered Head/Chest Sets. RCA Type MI-2454-B, Complete. **NEW**, packed for export. **EACH** \$8.75
 Model ATD Aircraft Transmitter, md. by Bendix. 50 Watts AM, 8-42, 40 Watts AS, 4-Channel motor tuning 1500 to 9,050 KC. Complete, with tubes, 24 V. Dynamotor, remote control, connectors, spare parts in box, all **NEW** Equipment. Export Packed. **Per Set** \$175.00

RADIOSONDE AN/AMQ-1, meteorological transmitter with sensitive instruments for measuring pressure, temperature, and humidity and means for modulating transmitter so that this information is transmitted while unit is in flight suspended from a balloon (not supplied). Standard battery powered, **NEW**, complete in cardboard casing, packed, ready for immediate use after installing batteries. Large Quantity Available. **WRITE FOR PRICES.**

LIMITED QUANTITIES Following: R-89/ARN-5A Receivers, new; APN-4 Indicators; TBY 2 Portable 28-80 mc Transceivers; TA-12B Transmitters; Model NAA Underwater UHF Radio Beacon Transmitters; Model ZB-3 Aircraft Homing Adapter Equipment; Portable Test Oscillators for ZB Eqpt.; RT-3/ARN-1 Altimeter Transmitter-Receiver; Receivers for DP-12 or 13 D.F. Receiving Eqpt; Radio Receivers BC-733-D; Model ATD Aircraft Transmitters; BD-72 Switchboards; 500 Watt, 10 DC to 110 AC, 60 cps motor-generators. Also, BC-603 Receivers, BC-604 and BC-684 Transmitters, BC-620 and BC-659 FM Transceivers, PE-97, 117, and 120 Power Supplies; Ship-to-Shore Radio Telephone for 32 V. & 110 V.D.C. operation. Large quantities of transformers, power and audio, filter chokes, Radar fittings and accessories.

ALL PRICES FOB, N. Y. C.
 Material Offered Subject to Prior Sale

TELEMARINE

COMMUNICATIONS COMPANY

540 West 27th Street
 NEW YORK 1, NEW YORK
 Cable Address: Telemarine, N. Y.

-CONNECTORS-

AN

101 & 102

"3100"

A & B

"3101"

Shell Types

"3102"

In Stock

"3106"

"3108"

Black
 and
 Mellomyne
 Inserts
 in Stock

Catalog On Request

CLAMP—ALL SIZES

FOR TYPES AVAILABLE SEE ELECTRONICS BUYER'S GUIDE

QUICK SERVICE OUR SPECIALTY

WILGREEN

99 Murray St., New York 7, N. Y.

For Immediate Delivery

Write or Phone - WORTH 2-7423-4-5

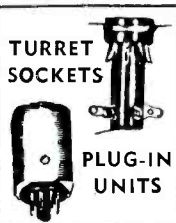

TURRET SOCKETS

PLUG-IN UNITS



AN CONNECTORS

IN STOCK AT
 50% DISCOUNT

AN

3100, 3101, 3102, 3106,
 3108 with any
 SUFFIX



Widely Known for Fair Dealing
 and Good Service

SEE JUNE ELECTRONICS for
 TWO FULL PAGES with
 PRICES

HAROLD H. POWELL

632 Arch Street

Philadelphia 6, Pa.

Market 7-5650

Ballentine . . . TSL-394 . . . Dumont . . . IE-19 . . . R.C.A. . . . TS-170 . . . Hewlett-Packard . . . TS-3 . . . General

TEST EQUIPMENT

The largest and most varied stock of Electronic Test Equipment available is performance guaranteed by the unexcelled facilities and competent engineers of

WESTON LABORATORIES

Weston 93, Massachusetts

Boonton . . . TS-14 . . . Stoddard . . . TS-173 . . . Lavoie . . . TS-27 . . . Precision . . . TS-100 . . . Shallcross . . . BC-787

**CONDENSERS
 OUR SPECIALTY**

OIL FILLED & TRANSMITTING MICA TYPES
 All Values and Voltage Ratings
 We Invite Your Inquiries

TECHNICAL RADIO PARTS CO.
 557 McDonald Ave., Brooklyn 18, N. Y.

SHEET METAL MACHINERY

NEW & USED—COMPLETE LINE OF
 Box Brakes, Press Brakes, Notchers, Shears,
 Punches, Rolls, Spot Welders—Di-Acro, Pexto,
 Whitney Equipment, etc.

B. D. BROOKS, INC. 361 Atlantic Ave.
 Boston, Mass. Tel. HANcock 6-5200

★ ★ ★ ★ ★ ★ ★ ★ ★ ★

R.C.A. Model MI-8167 TRANSMITTERS

Point-to-point communications

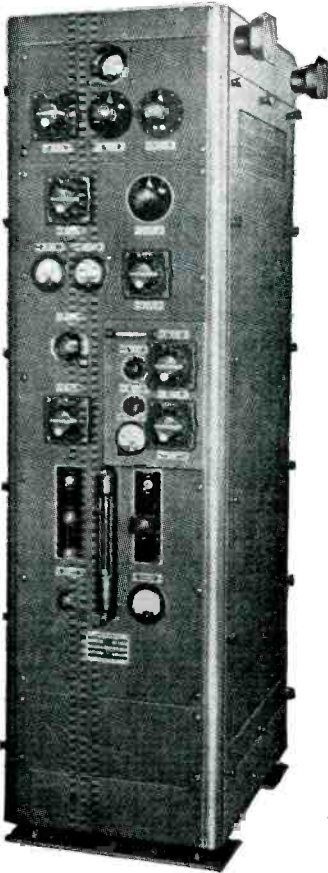

Freq. Range: 2000 to 20,000 Kcs.
Output: 350 Watts C.W.
250 Watts Radiotelephone
Input: 190 to 250 Volts AC 50/60 cps.
Size: 60" high, 17" wide, 27" deep
Tubes: 807s, 813s, 805s, 866s
Master Oscillator unit built-in, fully shielded and stable. All self contained including antenna network. Crystal Multiplier units (available) fits in place of M.O. unit. Speech amplifier is only external unit and has 110/220 v. AC input, four stages, high gain. Total net weight, 625 lbs.

Complete! New! Quantities!

★ ★ ★ ★ ★ ★ ★ ★

Other Choice Selected Transmitters, Receivers and Combinations. Handy-Talkies, Walkie-Talkies, Portable Radars Also Available.

Pictorial listings on request.

★ ★ ★ ★ ★ ★ ★ ★

COMMUNICATION DEVICES CO.

2331 Twelfth Ave.
New York 27, N. Y.

Cable: COMMUNIDEV Tel: AD-4-6174, 5

★ ★ ★ ★ ★ ★ ★ ★ ★ ★

RELAYS ARE OUR SPECIALTY WE HAVE OVER 200,000

WE ALSO HAVE LARGE STOCKS OF:

- | | | |
|------------------|-----------------|--------------|
| AV Connectors | Controls | Relays |
| APC's | Crystals | Resistors |
| Blinding Posts | Filters | Servo Xfms. |
| Cable | Fuses | Shock-Mounts |
| Capacitors | Hardware | Sockets |
| Ceramics | Iron Core Slugs | Spaghetti |
| Ceramics | Knobs | Switches |
| Chokes | Potentiometers | Transformers |
| Circuit Breakers | (sine-cosine) | Tubes |
| Coils | Pulse Xfms. | And Others |



SOLENOIDS

- | | |
|----------------------------------------------------------------------------------------------------------------------------------------|-------|
| B5A ALLEN BRADLEY 24VDC SPST 50A 100 ohms #R105 | 51.95 |
| B5A HART Cat. #692R4 SPST 50A, 150 ohms, #R105H | 1.95 |
| B5A SQUARE D 24VDC SPST 50A 150 ohms #R25 | 2.25 |
| B5A CUTLER HAMMER 24VDC, SPST 50A 100 ohms #R24 | 2.25 |
| B4 AUTO LITE 24VDC, SPST 200A 90 ohms #R174 | 3.50 |
| B4 HART M569A Cat #694R19, 24VDC, SPST 200A, 75 ohms #R127A | 2.95 |
| B8 CUTLER HAMMER 6041H139A, 24VDC, SPST 200A, 10 ohms #R130 | 3.95 |
| B8 AUTO LITE SPEC #32424A, 24VDC, SPST 200A 6 ohms #R128 | 2.75 |
| D1 ECLIPSE DIEA 53528, 24VDC SPST 200A 6 ohms #R126 | 2.95 |
| CUTLER HAMMER 6041H136A, 12VDC, SPST 200A 17 ohms #R121 | 3.95 |
| D1 CUTLER HAMMER D1-9432181, 24VDC, SPST 200A 50 ohms | 3.95 |
| LEACH 5030CSP, 12VDC, SPST 50A, 25 ohms #R123 | 1.95 |
| LEACH 79733, 24VDC, Dble Make & Break 50A, and SPST n.o., 65 ohms #R131 | 2.50 |
| G.E. 429896, Plastic Enclosed, 24VDC, SPST 50A 150 ohms #R23 | 2.95 |
| G.E. CR2792D116W2 Plastic Enclosed, 12VDC, SPST 100A, 30 Ohms #R23B | 5.50 |
| EPCO S47D, 12VDC, SPST 30A, 35 ohms #R122 | 2.95 |
| RBM BNS, 24VDC SPST 50A, 200 ohms #R224 | 1.95 |
| G.E. CR2800384A3, 24VDC, SPST, 200A, 50 ohms #R59B | 2.95 |
| G.E. CR9533K100A2, 24VDC, 2 switchettes, DPST n.c. & SPST n.c. long throw #R132 | 9.95 |
| GUARDIAN 34585 Dual Latching 24VDC ea section: Double Make & Break & Alternate Double Make, Break, 100A contacts, 24 ohms #R223 | 8.75 |
| G.E. M29J682-1 (No Contacts) 10-12VDC—Micalex Flipper Arm. Releases at 2VDC #R167 | 1.25 |



MINIATURE RELAYS

- | | |
|----------------------------------------------------------------------------------------------------------------------|---------|
| 55251 TELECHRON , 24VDC, SPST n.o. 300 ohm, #R174 | 5.90 |
| 55340 PRICE , 24VDC, SPST n.o. 300 ohm, #R170 | .90 |
| 55342 TELECHRON , 24VDC, Makes 3 Breaks One, 300 ohm, Anti-Capacity Arms, Low Loss Bakelite Insulation, #R171 | 1.25 |
| 55526 COOK , 24VDC, Makes 2, Breaks One, 300 ohm, Ceramic Insulation, #R107 | .95 |
| 55528 TELECHRON 12VDC, 6PST n.o., 150 ohms, #R145 | 1.35 |
| 55589 RBM , 24VDC, DPST n.o. 300 ohm, #R108G | 1.25 |
| 55837 G. E. , 24VDC, Double Make, 300 ohm, #R108R | 1.00 |
| 55837 RBM , Same as R108G, #R108R | 1.25 |
| 55837 ALLIED , Same as R108G, #R108 | 1.50 |
| D163221 AMER. TOTALIZATOR , 24VDC, SPDT, 300 ohms, Anti-Capacity Arms, #R134 | 1.25 |
| GUARDIAN , 24VDC, SPST n.o., 300 ohms, Anti-Capacity Arm, Ceramic Insulation, #R106 | .59 |
| 23012-0 RBM , 24VDC, SPDT, 250 Ohms, #R172 | 1.25 |
| 7252 ARC , 24VDC, DPST n.o. 300 ohm, Anti-Capacity Arms, Ceramic Insulation, #R354 | 1.25 |
| A13415 CLARE , 12VDC, DPST n.o., 120 ohms, #R246 | 1.25 |
| A21577 CLARE , 24VDC, DPST n.o., 250 ohms, #R352 | 1.15 |
| P2 LEACH (Pair on Bakelite Strip) Each Relay: 6VDC, SPDT, 125 ohms, #R353 | 1.25 pr |
| ZH7628-1 AUTOMATIC , 12VDC, Make One, Break Two, 640 ohms Dual Telephone Type Contacts #R244 | .85 |
| 7472679 G.E. 3VDC SPST n.c. 30 ohms, #R59A | .59 |
| 2VDC, SPDT, 125 ohms, #R173 | .69 |

OIL FILLED CAPACITORS

RECTANGULAR

Mfd.	WVDC	Ea.	Mfd.	WVDC	Ea.
2x0.1	7000	1.69	1.0	2000	1.85
0.2	5000	2.25	1.5	330AC	.89
0.25	4000	1.95	5	25	.49
0.75	1000	.69	7	600	1.45
1.0	400	.30	3x8	5	1.95
1.0	600	.65	17.5	330AC	3.25
1.0	1500	1.49	Filterette	50V3A	.59

OIL FILLED CAPACITORS

BATHTUBS

Mfd.	WVDC	Term	Ea.	Mfd.	WVDC	Term	Ea.
2x0.1	600	Bot.	.35	1.0	400	Side	.55
3x0.1	600	Bot.	.40	2x1.0	600	(2) Side	.65
0.2	440AC	Side	.40	2.0	400	Side	.60
0.25	600	Top	.40	2.0	600	Bot.	.65
0.5	600	Bot.	.45	4.0	50	(1) Side	.65
0.5	600	Top	.48	50	25	(1) Side	.30
2x0.64	600	Side	.45	100	25	(2) Side	.65

CHANNEL

Mfd.	WVDC	Term	Ea.	Mfd.	WVDC	Term	Ea.
0.015	600	Top	.28	2x0.5	200	(2) Bot.	.35
2x0.1	600	Bot.	.35	0.5	400	Bot.	.40
3x0.1	400	Bot.	.40	0.5	600	Bot.	.48
3x0.1	600	Bot.	.45	1.0	400	Bot.	.48
2x0.25	600	(2) Bot.	.48	1.0	400	Top	.48

Write Us Your Needs for Immediate Quote
PRICES FOB OUR PLANT Min. Order \$5.00

Universal general corp.

324 CANAL ST. N. Y. 13, WA. 5-9642

SAVE \$\$ ON BRAND NEW TUBES

1827	517.95	4J52	5199.50	7248	52.75
1838	29.95	6AB7/1852	1.39	725A	5.75
2C40	9.95	6A56	3.19	726C	49.50
2C44	1.44	6F4	4.50	832	5.75
2C51	4.95	6K4	3.49	832A	9.95
2D21	1.99	6SH7GT	1.36	836	2.95
2J21A	9.50	12A6	.89	837	1.95
2J22	11.95	12H6	.89	872A	1.95
2J21	29.95	32L7GT	1.79	884	1.75
2J22	29.50	250R	9.95	1616	1.38
2J23	29.50	304TL	12.50	1625	.45
2J34	29.50	446A	1.19	1629	.39
2J56	199.50	464A	9.95	5651	3.00
2J62	38.95	700A B D	16.50	8020	1.98
3B24	3.95	706CY	39.50	8025	4.95
3E29	19.95	707B	49.50	9001	1.75
3Q4	.89	706GY	14.95	9002	1.50
3S4	.89	717A	1.19	9003	1.75
4C35	29.95	723A/B	1.19	9004	.45
4J31	89.50		1495	9005	1.75

1000's OF OTHER TYPES IN STOCK! 25% Deposit with order—Balance C.O.D.
We Carry a Complete Stock of Radio & TV Tubes & Electronic Parts. Send us your inquiries. **J. S. H. SALES CO.** WE PAY HIGHEST PRICES FOR SURPLUS STOCKS OF TUBES & ELECTRONIC PARTS. Send us your list.

Dept. E-2, 7552 Melrose Ave., Los Angeles 46, Calif.

BRAND NEW STANDARD BRAND TUBES

OA3 VR75 \$1.49	3B7 1291 .49	10Y .75	531 7.50	803. 3.95	872A. 2.39	8020 1.95	CATHODE RAY TUBES
OB3 VR90 1.25	3B22 ELIC 2.75	12V6 .75	533 175.00	804. 9.95	874. 1.49	8021 2.89	
OC3 VR105 1.25	3B24 3.75	24G .49	559 3.95	805 3.95	876. 1.43	8025A 7.95	3CP1 S1 1.95
OD3 VR150 1.05	3C24 1.95	39 44. .49	700A 24.50	807 1.69	879. 6.95	9001 1.50	3DP1 4.95
1B22 3.25	3C28 4.95	45 Spec .35	701A 4.95	810 1.25	931A 2.95	9002 1.35	3FP7 1.95
1B26 2.75	3D6 1299 .49	100TH 9.75	702A 6.25	812 2.95	954 .35	9003 1.25	4AP10 4.95
1B27 19.95	3D3 4.95	152TH 19.95	703A 3.49	811 2.95	955 .65	9004 .35	5AP1 3.49
1B29 4.75	4A1 1.75	205B .75	704A 1.00	813 7.95	956 .69	9005 1.30	5FP7 3.95
1B36 14.95	4-250A 34.50	211 .75	705A 2.89	814 3.95	957 .35	9006 1.30	7BP5 18.95
1B56 47.50	4B28 S2894 4.75	217C 18.00	707A 12.95	828 11.95	958A .49	9007 8.95	7BP7 6.95
1DKGT .89	4E27 257B 15.95	250R 18.95	707B 17.50	829 11.95	959A .69	9008 4.95	9LP4 12.95
114 .89	4J22 149.50	250TH 23.25	708A 4.75	829B 14.95	1608 4.95	9009 3.75	10BP4 18.95
1R4 1294 .69	4J26 159.75	250TL 19.95	710A 8011 1.25	830B 12.95	1613 .99	9010 1.98	12LP4 21.50
2C22 7193 .35	4J34 195.00	285A 10.95	710A 8011 1.25	832A 12.95	1616 .95	9011 .45	12LP4A 22.25
2C26 .39	4J35 195.00	286A 18.95	711AY 5.95	832B 8.95	1616 5.95	9012 1.95	14BP4 26.50
2C34 RK34 .29	4J42 700A 27.50	304TH 13.95	715 6.95	837 1.65	1624 1.95	9013 1.95	16RP4 37.00
2C44 4.95	5D21 24.50	304TL 12.95	715B 12.75	838 4.95	1625 .45	9014 .75	17BP4A 37.00
2J22 7.95	6B8 .98	310A 6.95	715C 24.50	843 .75	1626 .45	9015 1.95	18BP4A 62.00
2J26 24.50	6C8 .88	316A 8.95	721A 4.95	846 49.95	1629 .35	9016 1.95	19AP4B 62.00
2J36 89.50	6C21 19.95	329A 11.95	722A 1.50	851 49.50	1636 3.25	9017 .98	20CP4 68.50
2J61 37.50	6F4 5.75	331A 4.95	723A B 17.95	860 24.50	1636 1.75	9018 1.95	TUNGAR BULBS
2J62 37.50	6J1 3.95	353A .95	724B 3.49	861 5.95	1651 2.95	9019 .95	6 AMP
2K25 24.95	7A7 .89	371B .95	725A 12.95	864 75	2051 .35	9020 1.95	289414 4.75
2X3G .98	7C4 .49	388A 39.50	730A 13.95	865 1.39	7193 .98	9021 1.95	Westinghouse Rectigon
2V2 .75	7E5 .69	450TH 44.50	801A .49	866A 1.30	8011 4.95	9022 2.50	
3A4 .69	7F7 .95	530 12.50	802 RK25 2.95	869B 39.50	8013A .39		

MARITIME INTERNATIONAL COMPANY

11 State Street, New York 4, N. Y.

Cable Address "Foxcroft"

Phones: Dlgy 4-3192-3

PANEL METERS

RELIABLE-SPEEDY-SERVICE

Large Stock—Guaranteed Accuracy

RECOGNIZED MAKES ONLY

(A) Weston (B) Triplet (C) Simpson (D) Weston Ltd (E) Westinghouse (F) Marion (G) G.E. (H) West. Elec. D.C. MILLIAMPS. D.C. MICROAMPS.

(A)506 0-1 Ma. 2" Rd. \$5.45	(F) 0-200Ua.2" Rd. \$5.45
(B)221 0-25 Ma. Each \$5.45	(A)506 0-500 2" Rd. \$8.95
100 Each	(A)301 0-100 3" Rd. \$16.95
200 2" Rd.	(A)301 0-200 3" Rd. \$12.95
300 2" Rd.	(A)301 0-500 3" Rd. \$12.95
500 2" Rd.	(G) 4 0-500 3" Sq. \$8.95
1000 \$4.95	D.C. VOLTMETERS
(C) 0-200 Ma. 2" Sq. \$4.95	(A)301 0-200 3" Rd. \$8.95
0-300 \$4.95	0-300 3" Rd. \$8.95
(D) 0-15 Ma. Each \$4.95	0-750 3" Rd. \$9.35
0-25 Each	(A)741 0-2KV. 4" Sq. \$19.95
0-50 Each	(A)506 0-500V. 2" Rd. \$8.95
0-100 2" Sq.	D.C. AMMETERS
1-150 2" Sq.	(E) 0-1 Amp. Each
0-200 2" Sq.	NX 35 0-2 3" Rd.
0-300 \$4.95	0-5 \$6.45
0-500 \$4.95	(A)301 0-10 Each
(A)301 0-1 Mil. Each \$4.95	0-15 3" Rd.
0-50 Each	0-30 \$8.45
0-100 3" Rd.	0-200* 3" Rd.
0-200 or Sq. \$5.95	0-300* \$13.95
0-300 3" Rd.	* With External Shunt.
0-500 \$7.95	RADIO FREQUENCY
(E) or (G) 0-15 Each \$5.95	(G) 0-3Amp. 2" Rd. \$4.45
NX 35 0-20 Each \$5.95	(C) 0-3 2" Rd. \$4.45
0-50 3" Rd.	(C) 0-2 2" Sq. \$4.95
0-100 3" Rd.	(D) 0-500Mils 2" Sq. \$4.45
0-200 or Sq. \$5.95	(A)301 0-5Amp* 3" Rd. \$14.95
0-500 \$7.95	* With ext. couple & Lds.
(C) 0-100 3" Sq. \$5.95	A.C. VOLTS
0-200 3" Rd.	(B) 0-150 3" Rd. \$6.45
\$5.95 0-500 3" Rd.	(E) 0-150 3" Rd. \$6.95
(A)741 0-1 Mil. 4" Sq. \$14.95	Weston Rectifier types available

Some types limited quantity. All meters subject to prior sale. Other types available to meet unusual requirements. Let us quote by return mail. TERMS: 25% with order balance C.O.D. Charges F.O.B. L. AMERICAN ELECTRONICS 29 South Park Ave. Rockville Centre, L. I., N. Y. Tel. Rockville Centre 6-0207

SORRY, NO RETAIL

50M Moulded Bushings for Pencil Flashlights.
30M Two-prong Sockets (for batteries).
1800—Jan 559 RCA Boxed Tubes.
1500—371A & 371B Jan Tubes. Also, 9LP7 & 5CP1.
1500—800 RCA — 2000—1630 RCA Boxed Jan.
50—Dynamotor AD-2—14V.—3A.—220V.—06A.
2000—T 4 1/2 Bayonet 6.3 Volt.
3000—Rheostats—15 Ohm 3 Watt.
5000—Toy Telekeys (cheap).
Various Large Antennas.
400—tube Ampl. (Chassis only, no Tubes or Spker).
600—3-tube Ampl. Chassis (partly assembled).
500—Dual Coil Sets (F & N Ranges) for RU-17 Aircraft.
500—Coil Sets CW 47135 (Range 2000-2500 KC).
25M Pilot Lights, Screw Base—Four Volt.
3000—2650 Mfd., 3 VAC. Sprague & Solar FP.
Moulded CERAMICON, 15 mhm F.-10%.
RESISTANCE WIRE, 750 ohms per inch (free samples).
SOLDER, 40/60 KESTER, solid, .030" dia (free sample).
BATHTUB COND., 1-600 volt, side terminals, ore. RF Choke, one mh, gty 3000, 1/2" pigtails (sample).
APC air-trimmer condensers; qty. from 8 to 40 plates.
ASST WAR SURPLUS TRANSFORMERS. CHOKES, etc.
MAIL NAME OF MFR. & HIS PART NUMBER
TG-5 Telegraph sets, strain insulators.
RADIO & TELEVISION TUBES, (BULK & BOXED).
CARBON & WW RESISTORS. TUBULAR & MICA CONDENSERS.
Gould Green Electronic Surplus
252 Greenwich St. N. Y. C. 7

TEST CHAMBER

Hot and cold; age 1942; used six months, like new;
Inside dimensions 30" x 58" x 28" high;
Temperature control—minus 57° F to plus 125° F;
Electric heating bank 6 KW; Servel Air Compressor, 2-stage; 7/2 H.P., 3/60/220 AC
Fans for circulation; inspection in operation
Guaranteed condition; F.O.B. Brooklyn.
Kings County Machinery Exchange
408 Atlantic Ave. Brooklyn 17, N. Y.

TUBE SPECIALS

VR-105 \$1.15	2X2 \$.95
VR-150 1.00	6B8 1.25
1R5 1.00	6SJ7 1.05
1S5 .95	866 1.20
1T4 1.00	6C21 40.00

See last issue for others

ARCBY ELECTRONICS

103 West Liberty
Louisville, Ky.

ELECTRONIC TUBE-MAKING MACHINERY

For manufacturing radio tubes, electronic tubes, cathode-ray tubes, lamps. New and used. Reasonably priced, satisfaction guaranteed.
AMERICAN ELECTRICAL SALES CO.
67 E. 8th St. New York, N. Y.

Your Inquiries to
Advertisers Will
Have Special Value...

—for you—the advertiser
—and the publisher, if you mention this publication. Advertisers value highly this evidence of the publication you read. Satisfied advertisers enable the publisher to secure more advertisers and —more advertisers mean more information on more products or better service—more value—to YOU.

DEPENDABILITY IN ELECTRONICS

WE ARE NATIONAL DISTRIBUTORS OF PARTS, TUBES AND EQUIPMENT. WE SOLICIT INQUIRIES FROM ORGANIZATIONS WHO APPRECIATE INTELLIGENT SERVICE AND HONEST PRICES, PARTICULARLY AT THESE CRITICAL TIMES.

NORMAN RADIO DISTRIBUTORS INC.
94-29 MERRICK BOULEVARD JAMACIA, N. Y. - REpublic 9-4651

← CHECK THESE MONEY-SAVING SURPLUS "BUYS"!

TECH MANUALS

Clearance of Our Entire Stock of

Out goes our entire stock of over 10,000 valuable, useful Tech Manuals at these drastically reduced prices—covering every phase of telephone, teletype, power units, transmitters, receivers, remote controls, etc. Check this list carefully—and buy what you need for today and the future! All prices are postpaid and include shipping and handling costs!

- TRANSMITTERS RECEIVER MANUALS**
- SCR-536 TM-11-235 Handle Talkie..... \$1.50
 - SCR-608-628 Tank Set..... \$1.50
 - SCR-593..... \$1.50
 - SCR-508, 528, 538 TM-11-600..... \$1.50
 - SCR-506A, TM-11-630..... \$1.50
 - SCR-593A..... \$1.50
 - SCR-543, TM-11-850..... \$1.50
 - SCR-300A, TM-11-242..... \$1.50
 - AN/TRC-1, 2, 3, 4, TM-11-2601..... \$1.50
 - AN/TTQ-1, 2 Tools, Gauges, & Maintenance Equipment..... 50¢
 - TOS Transmitter-Receiver Manual..... \$3
- TELEPHONE & TELETYPE EQUIPMENT MANUALS**
- Model 14 Type Bar Tape Prints, Parts List & Photos..... \$1
 - Model 14 Teletype Perforator..... \$1
 - Western Electric Voice Frequency Ringer Packaged Equipment..... \$1
 - Western Electric Voice Frequency Telephone Repeaters, Packaged Equipment..... \$1
 - Telephone Central Office Set, TC-2..... \$1
 - Telephone Central Office Set, TC-4..... \$1
 - Telephone Central Office Set, TC-10..... \$2
 - Repeater Set, TC-19, TM-11-2005..... \$1
 - RC-261 TM-11-2632 Remote Control Equipment..... \$1
 - BE-77A TM-11-359 Line Unit..... 50¢
 - BD-71 Switchboard..... 50¢
 - AN/TRA-2 Remote Control Equipment..... \$1
 - TS-26/TSM TM-13-2017 Test Set..... \$1
 - I-72-1 TM-11-3078 Generator..... \$1
- POWER UNITS & RECTIFIERS TECH MANUALS**
- PU-58/G Generator Set..... \$1
 - PE-49F Generator Set..... \$1
 - PE-75 Generator Set..... \$1
 - RA-24 TM-11-959 Rectifier Unit..... \$1

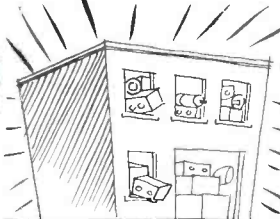

WAREHOUSE SALE! CLEARANCE SALE!

BEAM MOTORS
3/4 R.P.M. \$3.95
 Postpaid in USA
 With instructions for use with 110 V 60 cy. use TV aerials, ham stations, etc.

AN/APR-5A RCVR.
 1000 to 6000 MC Range
HI-VOLTAGE PWR. SUPPLY
 15 KV.
 Write for complete information

WESTON AIRCRAFT METER
 1-Milliampere Zero Center **\$1.95**
 Postpaid in USA
 FB for field strength meters, grid-dip or tuning meters, beam antenna indicators, vacuum volt indicators. Brand new.

VIBRATOR TRANSFORMER
\$1.49
 F.B. that mobile rig. 6 V. Input 345 V. 135 Ma. Output 15 V. Bias tap. Shipping wt. 4 lbs.

TRANSFORMER BUY
98¢
 110 V. 60 cy. Input-Output 33 Volts tapped at 13, 11, 10, 9 at 3 amps. Shipping wt. 4 lbs.

GRID DIP METER KITS
\$7.95 Postpaid In USA
 100's sold! Tells where your eqt. is in the radio spectrum. 955 OSC. range 3 to 170 mcs. Requires 6.3 filament. 150 V DC. With instructions on calibrating coils, etc.

Compare These MOUNTING RACKS Clearance Prices!

- MT-171/U (Double ATR)..... \$2.50
- MT-167/U (Single ATR)..... 1.50
- MT-103/APX-1 (BC-966)..... 2.00
- NT-137/APQ-13..... 3.50
- MT-14/ARN-1..... 2.50
- MT-149A/APS-13..... 2.75
- FT-213A (SCR-629 Compass)..... \$2.50
- FT-291 Loran with (tilt)..... 3.00
- FT-446 (Loran)..... 2.00
- FT-409 (BC-929 Scope)..... 2.00
- FT-225A..... 1.00
- FT-227A..... 1.00

ORDER DIRECT FROM THIS AD

Prompt shipment of all orders. Cash with order. Minimum order \$3.00. 35% deposit on all C.O.D. trucks or RA Express by lect. California buyers please add state sales tax. All prices subject to change. All merchandise subject to prior sale.

A Complete FOREIGN DEPARTMENT Fully Staffed For EXPORT ORDERS. We maintain a complete staff of Export Specialists to take care of all Foreign Orders. Correspondence and prompt replies in all languages. Address: "Foreign Department, Alvaradio".

ALVARADIO SUPPLY CO.

Dept. L-15, 341 S. Vermont Ave., Los Angeles 5, Calif., DUNKIRK 8-2211

PHOTOCON SALES

1062 N. Allen Ave. SYcamore 4-7156
 Pasadena 7, Calif. RYan 1-8271

WRITE FOR OUR LATEST SURPLUS SALES CATALOGUE

WE WILL BUY YOUR NEW OR CLEAN USED ELECTRONIC SURPLUS: ARC-1, ARC-3, BC-224, BC-348, BC-312, BC-342, ATC, ART-13, APS-13, BC-221, LM's, TS-12, TS-23, TS-34, TS-35, IE-19A, I-222, SCR-522, TS-100, I-100, or any BC, I, IE, TS, APR.

APR4, APR5A, APR7, TS-34, TS-12, 804CS2, APA-38, BC-348, ART-13

WRITE FOR PRICES.

- L. & N. 8662 Potentiometer..... EXCELLENT \$300.00
- L. & N. 4725 Wheatstone Bridge with 2420C Galvanometer..... NEW 350.00
- Weston 769 Electronic Analyzer..... LIKE NEW 225.00
- Weston 799 Insulation Tester 0-10,000 meg..... LIKE NEW 75.00
- Weston 779 Analyzer..... LIKE NEW 125.00
- Weston 665 Volt-ohm-Milliammeter, case, and model 666 socket selector..... 100.00
- Bristol Dynamaster Recorder-Controller KRQ1531 for Resistance Thermometers 130-145 ohm..... LIKE NEW 500.00
- Bristol Pyromaster Potentiometer Recorder Controller KR531 0-10M. V..... EXCELLENT 400.00
- Varia-General Radio Type 50A 0-135 V. @ 60 amps..... EXCELLENT 95.00
- APN-1 Altimeter Indicator 0-1 M.A. 5 M.A. shunt, 250° dial..... NEW 2.95
- 2" Aircraft Meter 1-0-1 millimeter scale calibrated 50-0-50..... NEW 1.95
- MG975-G-1 Onan Motor Generator-Motor 115/230V. 60 cy. single phase. Generator 115V. AC. 480 cy. 5.3 amps. 26V. D.C. @ 4 amps..... NEW 190.00
- Standard Signal Generator—Measurements Corp Model 78-B 15-25 MC. 100-230 MC..... EXCELLENT 99.50
- Weston Model 506 Voltmeter 0-20,000 volts with 4 Model 505 multipliers..... NEW 39.50

One of the largest and most complete electronic surplus stocks in the country. We have thousands of tubes, capacitors, plugs, accessories, transmitters-receivers, test equipment, etc. Send us your requirements.

TERMS: Prices f.o.b. Pasadena, California. 25% on all C.O.D. orders. Californians add 3% Sales Tax. Prices subject to change without notice.

RADAR
 SCR 545A Search and Track. Complete trailer, power supply and spare parts. Nearly new. Write for description and price.
PORTABLE PUMP ASSEMBLY
 Leland, 110 v. 60 c. 1 ph., 1/3 H.P. motor and D. Roper #2 hydraulic pump. 300 lbs. PSI max., 125 lbs. PSI continuous @ 3.25 gallons per min..... \$52.00

SEARCH LIGHT
 Signaling, 12" Curtis Lighting, Inc. 115 v. a-c or d-c, 1000 watt. Complete w/bulb. Comes w/mounting assembly that gives 360° horizontal rotation and 180° vertical rotation..... \$27.50

WATER COOLING HEAT EXCHANGER:
 10 KW, Westinghouse RU-3-B, includes radiator, fan, pump, visual & electrical temperature & pressure indicators. 110 v. 60 c. Complete in steel housing 24"x31"x52" \$165.00

MOTOR
 Bendix 1/15 HP, 115 v. 60 c. 1 ph. 1800 RPM. \$4.75

GENERATOR
 Bendix model NEA3. Output 115 v. a-c 10.4 amps, 300 cy. SP, and 28.5 v. d-c. 60 amps @ 2400 RPM. Self excited, splined drive. New. Orig packing. \$27.50

BATTERY CHARGER TRANSFORMER
 G. E. Cat. #WS-99316. Pri. 105-115-125 v. 60 c. Sec. 105-90-75-60-45-30 v. @ 6 amps. each side of center tap. Voltage reduced 10% and 20% thru tapped primary; two x 5v. 18 amp. C.T. (Tungar filaments) and two x 7 v. 10 amp. 7 1/2" h. x 8 3/4" w. x 5 1/2" d. Wt. 56 lbs. New, orig. packing. G. E. price \$52.00. \$17.50 2 for \$30.00

NEW!

- low prices
- values
- equipment
- components

Note: All merchandise not designated as new is guaranteed to be in excellent to new condition.

EPCO
 1527 E. 7th St.
 Los Angeles 21, Calif.

POWER SUPPLY COMPONENTS TRANSFORMERS
 Plate, American Transformer Co. Spec. 29108. Pri. 115 v. 60 cy. 10.4 kVA. Sec. 17,800 v., 320 amps., 35 KVA test. \$65.00
 Plate, American Transformer Co. Spec. 29108. Same as above but center-tapped to handle 1 amp @ 8800 v..... \$75.00

CONTACTOR
 Allen-Bradley & Westinghouse, 115 v. 60 cy. coil. DPST, 15 amps..... \$4.95
HIGH VOLTAGE RECTIFIER POWER SUPPLY
 Variable output 0-15,000 v. d-c @ 500 mls. Input 115 v. 60 cy. SP. Army type RA-38. Size 6 3/4" x 5 3/4" x 5 6/8". Wt. 2040 lbs. Units are new, complete with spare tubes and remote control. Write for detailed information.

Filament, American Transformer Co. Spec. 29106, Type WS, .050 KVA, 50/60 cy SP., 35 kVA test, 12 KV d-c operating. Pri. 115 v., Sec. 5 v., 10 amps w/integral stand-off insulator and socket for #37 d-c. East Cat. #A7548, oil..... \$12.50
 872, etc. rectifier tubes..... \$2.50
 2 for \$22.50-1 for \$40.00

CAPACITORS
 9.12 mfd., 1265 v. 60 c. a-c or 4000 v. d-c power factor correction 5.0 KV. A.I.T. Cat. #2528908..... \$17.50
 .25-.25, 6000 v. d-c or .125 @ 12,000 v. d-c. East Cat. #A7548, oil..... \$3.75
 1.25/1.25 mfd., 7500 v. Cat. #26F360 \$12.50
 2x.15 mfd., @ 8000 c. or .075 mfd., @ 16,000 v. Vitamin Q..... \$2.90

RESISTORS
 Fixed, w.w. 160,000 ohm, 200 w. ferrule ends..... \$1.00
 Fixed, w.w. 5,000 ohm, 200 w. ferrule ends..... \$1.00

METERS
 3" Westinghouse & Weston 0-1 ma. d-c movement, calibrated 0.4 or 0-20 KV Mod. 301. NX35..... 4.95
 3" Westinghouse & Weston 0-120 amp. a-c calibration, 3 amp f.s. deflection. Includes doughnut current transformer 40/1 ratio. Mod. NA35 & 476..... \$8.50

RELAY
 Magnetic overload, Allen-Bradley #810, 6.3-18.1 amps. 600 v. max..... \$7.95

RECTIFIER
 Dry Disc, 6.5 v. a-c FWCT, 2.2 v. d-c @ 3 amps..... \$.75 4 for \$2.00

TRANSTAP
 115/230 v. 50/60 c. 0-260 v. 2.5 amp output..... \$1.50 2 for \$30.00

LAB. INSTRUMENTS
G. R. 1302-A..... \$350.00
DuMont 208-B..... \$225.00
 fob Sacramento
G. J. MAKI, Rt. 4 Bx 3862-AA
 Carmichael, Calif.

FOR SALE
200 MOTOR STARTER RELAYS
 Cutler-Hammer #619, 110 volt 60 cycle coll, 4 pole 600 volt 25 amp. contacts.
L. R. RUOFF
 94-18 51 Ave, Elmhurst, N. Y. HA 9-2954

10 MFD 600 VOLTS 75 CENTS

Although rated at 400V against an operating temperature of 72°C, these nationally famous 5+5 MFD capacitors will meet all commercial specifications and operate at 600V provided that the operating temperature does not exceed 40°C. Measuring 3 5/16 x 2 x 3 25/32 and packed 24 to a carton, weighing 42 pounds this item fills the need for an excellent filter and power correction device. Long lasting, extremely low in dielectric leakage and available in sufficient quantity for a large manufacturer. Small quantities—\$.87. Carton quantities—\$.65. Samples upon request.

WESTON LABORATORIES

Weston 93, Massachusetts

WANTED

WANTED

COMPLETE TUBE INVENTORIES

RECEIVING, SPECIAL PURPOSE, TRANSMITTING TUBES
MAGNETRONS AND KLYSTRONS

Quick Action—We Pay Cash

MARITIME INTERNATIONAL COMPANY

11 State Street

New York 4, N. Y.

WANTED

YOUR SPARE SURPLUS EQUIPMENT

DYNAMOTORS • SELSYNS • AUTOSYNS • INVERTERS • TRANSMITTERS
RECEIVERS • TEST EQUIPMENT

Please send list stating condition and lowest price.

No Quantity Too Small or Too Large!

C & H SALES COMPANY

BOX 366-SE EAST PASADENA STATION

PASADENA 8, CALIFORNIA

TEST EQUIPMENT WANTED

Because the nation's defense efforts are being accelerated, an unusual opportunity exists to dispose of high quality test gear at high prices. If you own any of the following pieces, please write or call collect. We will promptly advise you of our best offer.

LAE	TS14	TS100	TS239
LAF	TS33	TS111CP	TS263
LAG	TS33A	TS155A/AP	TS268
1208	TS34/AP	TS155B/AP	TS270A
1222	TS34A/AP	TS173/UR	TS323
TS3/AP	TS35	TS174	TSK-4SE
TS12	TS36	TS175	TSS-4SE
TS13	TS47APR	TS195	TSX-4SE

We will also purchase Rad-Lab equipment, GE, Ferris, Boonton, Stoddart, Doolittle, Hewlett-Packard, etc. Prompt replies assured.

Weston Laboratories
Weston 93, Mass.

WANTED

400 cycle, 115 volts, 2 to 5 kw output
MOTOR ALTERNATOR
60 cycle input

MR. MERSEREAU

EASTERN AIR DEVICES

585 Dean Street

Brooklyn 17, N. Y.

WANTED

"S" TYPE RADAR PARTS

Write or Phone

World Wide Packing & Shipping Co.
350 Pearl St. Brooklyn, N. Y.

MA 4-8371

NEED ART-13; ARC-1; ARC-3; DY-17; TS-12; TS-13; MN-26 J or K; BC-342; BC-312; 1-100; BC-348; BC-611 Handie Talkie (or any part); BC-788 A, AM, B or C; 1-152A, AM, B or C; TS-67; teletype; test or any other equipment. Will trade. Write:

BOB SANETT (W6REX)

4668 Dockweiler, Los Angeles, California

WANTED

Teletypewriters complete, components or parts. Any quantity and condition.

W-6864, Electronics

330 W. 42nd St., New York 18, N. Y.

WANTED

WESTERN ELECTRIC VACUUM TUBES

Types 101F, 102F, 272A, 274A or B, 310A or B, 311A, 313C, 323A, 328A, 329A, 348A, 349A, 352A, 373A, 374A, 393A, 394A, 121A Ballast Lamps.

W-6863, Electronics

330 W. 42nd St., New York 18, N. Y.

WANTED

AMPHENOLS—UHF CONNECTORS
PULSE TRANSFORMERS—RELAYS
NET WORK—MICRO SWITCHES
6V DYNAMOTORS

E. SMITH Room 12-391 Fulton St., Brooklyn 1, N. Y.
Phone MAIN 4-2666

WANTED

DYNAMOTORS

DM-34, DM-35, DM-36 and DM-37.

Must be new. Any quantity.

W-9414, Electronics

330 W. 42 St., New York 18, N. Y.

WANTED

Tubes, Test equipment, Condensers, & general inventories. Highest prices paid.

W-9948, Electronics

330 W. 42nd St., New York 18, N. Y.

Quick ANSWERS to your business problems . . .

HUNDREDS of miscellaneous business problems can be quickly and easily solved through the use of the Searchlight Section of this or other McGraw-Hill publications.

The Searchlight Section is classified advertising; you can use it at small cost, to announce all kinds of business wants of interest to other men in the fields served by these publications. It is the accepted meeting place of men with business needs and the men who can fill those needs. When you want additional employees or a position, want to buy or sell used or surplus equipment, want products to manufacture, seek new capital or have other business wants—advertise them in the Searchlight Section for quick, profitable results.

The SEARCHLIGHT Classified Advertising SECTIONS OF McGRAW-HILL PUBLICATIONS

American Machinist
Aviation Week
Business Week
Bus Transportation
Chemical Engineering
Chemical Week
Coal Age
Construction Methods & Equipment
Electrical Construction & Maintenance
Electrical Merchandising
Electrical World
Electronics
Engineering and Mining Journal
E. & M. J. Metal & Mineral Markets
Engineering News-Record
Factory Management and Maintenance
Fleet Owner
Food Industries
Power
Product Engineering
Textile World
Welding Engineer

Classified Advertising Division

McGRAW-HILL PUBLISHING CO., Inc.

330 West 42nd Street
NEW YORK 18, N. Y.

CONDENSER SPECIALS—

10 mfd.—600 V \$.75
 Three term. bot. mntg. channel type. Dims. 3 3/4" x 3 1/2" x 2". Two 5 mfd. sections rated 400 V at 72 deg. "C". 1800 V test. Meets commercial specs. for 600 V operation up to 40 degs. "C". Ideal for filter or power factor application where ruggedness and quality are paramount. Carton of 24 weight 42 lbs.

16 mfd.—600 V \$1.75
 Dual 8 mfd oil filled cond. hermetically sealed and packed. Tobe type PT-SC-11 measuring 3 3/4" x 2 3/8" x 2 3/8". Stud mtg. centers 2". Plugs into standard four prong socket. *Quantity discount.*

7 mfd.—600 V \$1.45
 Small, high quality oil cond. by a leading mfg. measuring only 2 1/8" x 3 3/4" x 1 3/4" complete with brackets.

6 mfd.—150 V \$.25
 Three term. dual 3 mfd. oil cond. complete with brackets, measuring 4 1/4" x 1 3/4" W x 1"

.25 mfd.—6000 V \$1.50
 Standard Brand cond. #25 F 659 measuring 3 7/8" x 3 3/4" x 2 1/4". *Quantity discount.*

2 mfd.—600 V \$.75
 Standard Brand cond. #26 F 407 measuring 2 3/4" x 1 3/4" x 1". Other makes available.

2 mfd.—1000 V Bathtub \$.19
 Side terms. Mtg. dim. 2 1/8" c-c. Large quantity available.

Large quantities of bathtub, channel and upright oil conds. from 25 V. to 25 KV. Trans. and receiving mics. Standard Brand pots, wire wound pots and 25 Watt. rheos. Inquiries solicited.

MONMOUTH RADIO LABS
 BOX 159 OAKHURST, N. J.

SELENIUM RECTIFIERS

F.W.B., FWCT, 3Φ, Volt. DBLR, etc.

Finest materials, workmanship and immediate deliveries
 COMPARE OUR PRICES.

Full Wave Bridge Types

	18/14	36/28	54/30
2 amps	\$2.50	\$2.75	\$5.25
4 amps	4.00	5.50	
8 amps	6.00	7.50	
12 amps	8.00	10.00	
24 amps	12.00	20.00	

—Selen. Rect. Transformer New, Herm. Sealed 110 V. 60 cy./6, 12, 18, 24, 30, & 36 V. @ 4 amps. \$3.95
 —New General Radio Model 50-B variacs @ \$100.00 ea.

SPECIAL TYPES TO ORDER.
 Inquire for quantity prices

BARRY ELECTRONICS CORP.

136 Liberty St. New York 6, N. Y.
 Phone: REctor 2-2563

25% deposit with orders—or send full remittance to save C.O.D. charges—rated firms (D&B) net 10 days.
 All merchandise fully guaranteed

FOR SALE

ELECTRICAL STEEL

We can offer about 26,000# of Hi-Grade Strip—.005 x 12 3/8" "Hipersil" 3 1/4% Transformer grade — In Coils weighing about 900# each—Material new and prime but outside wrap weather discolored.

GLOBE TRADING COMPANY
 1815 Franklin Detroit 7, Michigan
 Phone—WOODward 1-8277

TUBE REBUILDING
 Large Transmitting and Power types

Economical • Guaranteed
FREELAND PRODUCTS CO.
 700 DRYADES ST., N. O., LA.

WANTED

WILL BUY

MN-26-K or -J
COMPASS RECEIVERS

APN-9, TS-67, R-89B/ARN-5, ARC-1, ARC-3, ART-13, BC-221, BC-348, SCR-522, MN-53, MN-61, RA-1, MN-31 MI-32 ARN-7, ANY BENDIX OR AIRCRAFT RADIO EQUIPMENT, DYNAMOTORS, INVERTERS, TEST EQUIPMENT WITH "TS-" OR "I-" PREFIXES

State Condition and Best Price

AIRCRAFT RADIO INDUSTRIES, INC
 274 Madison Ave., New York City

WANTED

Your Surplus Laboratory Equipment, Tubes and Parts

Particularly items of good quality—
 Boonton, Ferris, L & N, G-R, etc.

Also MILITARY SURPLUS items, such as ARC-1, ARC-3, ART-13, APR-1, APR-4, APR-5A, BC 348, etc. Transmitters, Receivers and components; TS-323, TS-173, TS-174, TS-175, BC-221, LAE, LAF, LAG Frequency Meters; TS-13, TS-14, TS-34, TS-35, TS-45, TS-146, TS-155, TS-263, BC-1277, all kinds "TS-" "IE-" and other Test Equipment needed, particularly for the Microwave Region; Spectrum Analyzers, etc., also all kinds of quantity stocks, spare parts, plugs and cable. Sell NOW, during this period of temporary shortage, and aid the defense effort.

We Buy for Cash, or Will Exchange for Needed Equipment

EDUCATIONAL INSTITUTIONS

and others who obtained donations of surplus equipment from the government: you are now legally free to sell, or exchange this equipment with us for items you can use. Write for details, listing your equipment, with condition and price.

Please Describe and Price Your Items in Your First Letter

We specialize in reconditioning and assembling complete sets of equipment for use in the nation's laboratories and factories. We can, for instance, supply complete APR-4 receiving equipment, with continuous coverage of the frequency range 38-4,000 MC.; technical details and quotations furnished upon request.

Engineering Associates
 434 Patterson Road, Dayton 9, Ohio

WE PAY TOP DOLLAR

for all types of

SURPLUS ELECTRONIC EQUIP.

Regardless of Condition. Ready Cash for:

- ART-13 Xmitter
- DY-17 Dynamotor
- TS-12 Test Sets
- TS-13 Test Sets
- MN-26 J or K
- BC-312 • BC 342
- BC-611 Handle Talkie (or any part)
- I-100 Test Sets
- BC-348 Revr.
- BC-788A, AM, B or C
- I-152A, AM, B or C
- ARC-1 • ARC-3
- Teletype Equipment
- Any Test Equipment
- TS-67

Plus anything you have in Electronics Equipment. Send your complete List, present condition and asking price to:

WEST REGION ELECTRONICS

Dept. E-3

1437 S. Norton Ave., Los Angeles 19, Calif.

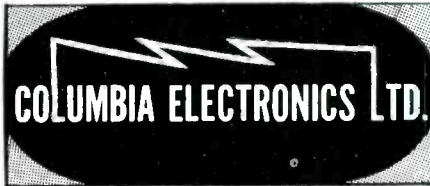

EQUIPMENT WANTED!

We want to buy all types of surplus electronic equipment. We are one of the largest buyers in U. S. We buy more because we give every seller top prices and a fair deal. TELL US WHAT YOU HAVE. USE COUPON BELOW—AND MAIL TODAY!

Use following numbers to indicate conditions: N-1, brand new; N-2, used, like new; N-3, used.

ITEM	CONDITION	PRICE WANTED

To: COLUMBIA ELECTRONICS LTD., 524 S. San Pedro St., Los Angeles 13, Calif.

Name
 Address

SEE COLUMBIA ELECTRONICS AD ON PAGE 303

INDEX TO ADVERTISERS

Acme Electric Corp.	228	General Electric Company	251
Acme Electronics, Inc.	265	General Radio Company	161
Aeronautical Communications		General Electric Company	
Equipment, Inc.	228	Apparatus Dept. 17, 35, 60, 61, 170,	207
Air Associates Incorporated	213	Carboly Dept.	28, 29
Aircraft-Marine Products, Inc.	34	Electronics Dept.	51, 75, 157
Aircraft Radio Corp.	234	Ozone Lamp Dept.	214
Airpax Products Company	234	Telechron Dept.	193
Alden Products Co.	198	General Transformer Company	206
Allen-Bradley Co.	26	Gertsch Products Inc.	263
Allen Co., Inc., L. B.	279	G. M. Laboratories, Inc.	261
Allied Control Company, Inc.	54	Graphite Metallizing Corp.	152
Allied Radio Corp.	232	Green Instrument Co.	269
Allmetal Screw Products Company, Inc.	269	Guardian Electric Mfg. Co.	221
American Electrical Heater Co.	186		
American Gas Accumulator Company	243	Hardwick, Hindle, Inc.	52
American Lava Corp.	33	Hathaway Instrument Co.	220
American Relay & Controls, Inc.	224	Haydon Company, A. W.	243
American Television and Radio Co.	276	Heath Company	226
American Time Products, Inc.	46	Heiland Research Corporation	270
Ampex Electric Corporation	271	Heli-Coil Corporation	229
Andrew Corporation	225	Helipot Corporation	183
Arco Electronics, Inc.	64	Hermetic Seal Products Company	226
Arma Corporation	36	Hewlett-Packard Company	15
Armo Steel Corporation	181	Hobson Bros.	275
Arnold Engineering Co.	165	Holtzer-Cabot Division of	
Art Wire & Stamping Company	267	National Pneumatic Co., Inc.	27
Astron Corporation	236	Hudson Wire Company	265
Audio Devices, Inc.	145		
Automatic Electric Sales Corporation	163	Improved Seamless Wire Company	240
		Industrial Condenser Corp.	269
Ballantine Laboratories, Inc.	172	Industrial Electronics Incorporated	152
Barry Corporation	78	Instrument Resistors Company	278
Bead Chain Manufacturing Co.	274	International Nickel Company, Inc.	185
Beaver Gear Works, Inc.	240	International Rectifier Corporation	249
Belden Manufacturing Co.	70	International Resistance Co.	5
Bell Telephone Laboratories	197	Irvington Varnish & Insulator Company	37
Bendix Aviation Corporation,			
Eclipse-Pioneer Division	248	Jackson Electrical Instrument Company	206
Red Bank Division	151	Jeffers Electronics, Inc.	253
Bentley, Harris Manufacturing Co.	153	Jelliff Mfg. Corp., C. O.	41
Bird & Co., Inc., Richard H.	271	Jensen Manufacturing Company	246
Bird Electronic Corp.	268	Johnson Co., E. F.	276
Birther Corporation	247	Jones Div., Howard B. Cinch Mfg. Corp.	257
Biwax Corporation	273	Joy Manufacturing Company	257
Bogue Electric Mfg. Co.	19		
Boontong Radio Corporation	141	Kable Engineering Co.	259
Borg Corporation, George W.	270, 271	Karp Metal Products Co., Inc.	53
Bowser, Inc.	241	Kartron	146
Breeze Corporations, Inc.	195	Kay Electric Company	266
Bridgeport Brass Co.	201	Keithley Instruments	169
Brubaker Mfg. Co.	279	Kenyon Transformer Company, Inc.	137
Brush Development Company	20, 251	Kester Solder Company	228
Burgess Battery Company	230	Knights Co., James.	68
Burlington Instrument Co.	241	Kollsman Instrument Corp.	68
Burnell and Company	23		
Bussmann Mfg. Co.	67	Lambda Electronics Corporation	265
		Lampkin Laboratories, Inc.	279
Calldyne Company	227	Lapp Insulator Co., Inc.	59
Cambridge Thermoionic Corp.	204	Leeds & Northrup Co.	22
Cannon Electric Co.	184	Lenz Electric Manufacturing Co.	154
Capitol Radio Engineering Institute	269	Lewis & Kaufman, Inc.	164
Carborundum Company, The	14	Lewis Engineering Co.	245
Centralab, Div. Globe-Union, Inc.	11, 12, 13	Lewis Spring & Manufacturing Co.	212
Chase Brass & Copper, Sub. of		Linde Air Products Co., A Division of	
Kennecott Copper Corp.	57	Union Carbide & Carbon Corp.	254
Chicago Telephone Supply Corp.	44, 45	Litton Industries	167
Chicago Transformer, Div. of		Lord Manufacturing Company	222
Essex Wire Corp.	194	Lorentzen, Inc., H. K.	173
Cinch Manufacturing Corp.	133		
Cinema-Television, Ltd.	63	Magnecord, Inc.	158, 233
Cleveland Container Company	187	Mallory and Company, Inc., P. R.	80, 135
Clippard Instrument Laboratory, Inc.	238	Marion Electrical Instrument Company	2
Cohn Corporation, Sigmund	268	Markem Machine Company	236
Condenser Products Company	7	McGraw-Hill Book Co.	239
Consolidated Engineering Corporation	178	Metal Textile Corporation	251
Cornell-Dubilier Electric Corp.	191	Metals & Control Corp.	
Corning Glass Works	40	General Plate Div.	42
Corry-Jamestown Mfg. Corp.	250	Mico Instrument Co.	276
Coto-Coil Co., Inc.	272	Milen Mfg. Co., Inc., James.	150
Cross Co., H.	279	Milo Radio & Electronics Corp.	266, 267
		Miniature Precision Bearing, Inc.	279
Dano Electric Company	262	Minneapolis-Honeywell Regulator Co.	232
Daven Co.	Third Cover	Mitchell-Rand Insulation Co., Inc.	8
DeJur Amco Corp.	269	Mosinee Paper Mills Company	192
Delco Radio Division, General		Muirhead & Co., Ltd.	3
Motors Corporation	147	Mycalex Corporation of America	219
Dial Light Company of America	226		
Dore, Inc., John L.	247	National Company, Inc.	253
Dow Corning Corporation	279	National Moldite Company	242
Driver-Harris Company	56	National Radiator Company	208
duPont deNemours & Company (Inc.),		Plastic Metals Div.	
E. I. Electrochemicals Dept.	256	National Varnished Products	
Polychemicals Dept.	203	Corporation, The	72
		Neo-Sil Corporation	39
Eastman Kodak Company, Industrial		New Hermes, Inc.	275
Optical Sales Div.	171	New York Transformer Co., Inc.	210
Edo Corporation	62	New Company, J. M.	230
Eisler Engineering Company, Inc.	263, 279	North American Aviation, Inc.	224, 257
Elitel-McClough, Inc.	73	North Electric Mfg. Co.	182
Electra Mfg. Company	150	Northern Radio Co., Inc.	273
Electrical Industries, Inc.	267	Notheifer Winding Laboratories	247
Electrical Reactance Corp.	25		
Electro Motive Mfg. Co., Inc.	65	Offner Electronics, Inc.	48
Electro-Voice, Inc.	188	Ohmite Mfg. Co.	16A, 16B
El-Tronics, Inc.	279	Olympic Metal Products Co., Inc.	252
Erle Resistor Corporation	69	Opad-Green Company	255
		Optical Film Engineering Co.	265
Fairchild Camera & Instrument Corp.	209	Owens-Corning Fiberglas Corp.	179
Federal Telephone & Radio Corporation	199		
Filtrol Co., Inc., The	9	Panoramic Radio Products, Inc.	258
Ford Instrument Company	239	Paramount Paper Tube Corp.	224
		Phalo Plastics Corp.	259

THE NEW "PRECISION" CR-30 CATHODE RAY TUBE TESTER

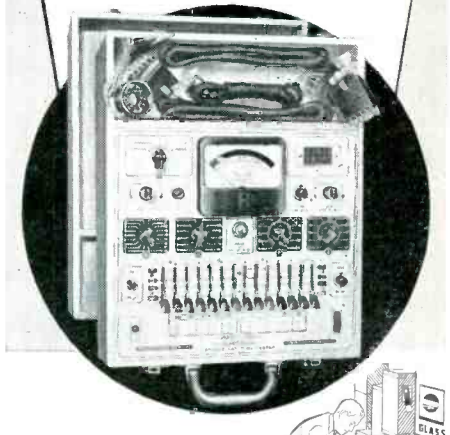

TESTS ALL TV PICTURE TUBES
(Magnetic and Electrostatic)
'SCOPE TUBES AND INDUSTRIAL CR TYPES



IN FIELD, LAB & WAREHOUSE
Tests CR Tubes without removal from chassis or carton!

A complete and self-contained Electronic Instrument. Incorporates a TRUE BEAM CURRENT Test Circuit. Checks overall electron-gun performance for proportionate picture brightness. Additional tests for accelerating anodes and deflection plate elements.

The Precision CR-30 should not be confused with mere adapters connecting to ordinary receiving tube testers which were never designed to meet the very specialized needs of CR tube checking. Similarly, it is not to be confused with neon-lamp units or similar devices of limited technical merit and which do not check all CR tubes or all tube elements.

- GENERAL AND TECHNICAL SPECIFICATIONS**
- ★ Tests All Modern Cathode Ray Tubes. Tests All CR Tube Elements: Not just a limited few.
 - ★ Free-Point 14 Lever Element Selection System, independent of multiple base pin and floating element terminations, for Short, Leakage and Quality Tests.
 - ★ True Beam Current Test Circuit checks all CR Tubes with Electron-gun in operation. It is the Electron Beam (and NOT total cathode emission) which traces the pattern on the face of the CR tube. The significance of the above rests in the fact that Beam Current (and picture brightness) is primarily associated with the condition of the center of the cathode surface and not the overall cathode area.
 - ★ Voltage Regulated, Bridge Type VTVM affords super-sensitive tube quality indications and positive check of low current anodes and deflection plates.
 - ★ Micro-Line Voltage Adjustment Meter-monitored at filament supply.
 - ★ Accuracy of test circuits closely maintained by use of factory adjusted internal calibrating controls; plastic insulated, telephone type cabled wiring; highest quality, conservatively rated components.
 - ★ Built In, High Speed, Roller Tube Chart.
 - ★ Test Circuits Transformer Isolated from Power Line.
 - ★ 4½" Full Vision Meter with scale-plate especially designed for CR tube testing requirements.

★ ★ ★
SERIES CR-30—In hardwood, tapered portable case. 17½" x 13¾" x 6¾". Complete with standard 12 pin tube cable and universal CR Tube Test Cable.

Shipping Weight: 22 lbs. Net Price: \$99.75
See the new CR-30 on display at leading electronic equipment distributors. Place your orders now to assure earliest possible delivery.

Precision Apparatus Co., Inc.
92-27 HURON HARDING BLVD.
ELMHURST 10, N. Y.

Export: 458 B'way, N.Y.C., U.S.A. Cables: MORHANEX
In Canada: Atlas Radio Corp. Ltd., Toronto, Ontario

FOR SERVICE IN COILS

No matter what your coil needs may be, you'll find in U.S.E. a dependable source of supply. For further details write for catalog today.

Cathode Trap Coils • I.F. Transformers • Width Control Coils
 Heater Choke Coils • Video Peaking Coils • R.F. Coils
 Horizontal Linearity Control Coils • Horizontal Oscillator Coils
 Oscillator and Solenoid Coils • Sound Discrimination Transformers
 Sound I.F. Transformers • Picture I.F. Transformers.

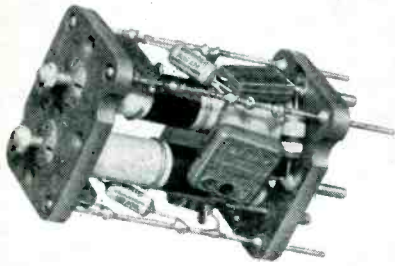

United States Electronics Corporation

Lyndhurst, New Jersey

Pickering & Co., Inc.	273
Plastoid Corporation	55
Polaroid Electronics Corp.	217
Polytechnic Research & Development Company, Inc.	271
Potter Instrument Co., Inc.	243
Precision Apparatus Co., Inc.	311
Precision Paper Tube Co.	249
Premax Products, Div. Chisholm-Ryder Co., Inc.	255
Presto Recording Corporation	31
Pyramid Electric Co.	76

Radio Corp. of America	190, 223
Fourth Cover	
Radio Materials Corporation	155
Radio Receptor Company, Inc.	189
Radio Wire Television Incorporated	274
Railway Express Agency, Air Express Division	177
Rauland Corporation	43
Raytheon Manufacturing Co.	143, 218
R-B-M Division, Essex Wire Corp.	156
Reeves-Hoffman Corporation	166
Reeves Instrument Corp.	269
Remler Company, Ltd.	262
Revere Copper & Brass, Inc.	18
Rox Rheostat Co.	279
Rohden Manufacturing Co.	273
Rome Cable Corporation	235
Runzel Cord & Wire Co.	261

Sanborn Company	79
Sangamo Electric Co.	74
Scientific Electric Div. of "S" Corrugated Quenched Gap Co.	215
Scintilla Magneto Division of Bendix Aviation Corp.	32
Secon Metals Corporation	261
Servo Corporation of America	232
Sessions Clock Company, Times Div.	168
Shakproof, Inc.	47
Sigma Instruments, Inc.	21
Southwestern Industrial Electronics Company	259
Specialty Battery Company	271
Sperry Gyroscope Company	175
Sprague Electric Company	139
Stackpole Carbon Co.	160
Standard Piezo Company	261
Standard Pressed Steel Co.	150
Standard Products, Inc.	267
Standard Transformer Corp.	174
Stanley Tools	245
Staver Company, Incorporated	265
Stevens Arnold Inc.	230
Steward Manufacturing Co., D. M.	71
Stoddart Aircraft Radio Co.	196
Sturtevant Co., P. A.	255
Superior Tube Company	211
Sylvania Electric Products, Inc.	77, 149
Sylvania Corporation	66
Syntron Co.	261

Technology Instruments Corp.	231
Tektronix, Inc.	278
Teltronics Laboratory, Inc.	279
Tenney Engineering, Inc.	180
Tensolite Insulated Wire Co., Inc.	239
Terpening Company, L. H.	202
Thompson Products, Inc.	6
Tielflex, Inc.	255
Transradio, Ltd.	241
Triad Transformer Mfg. Co.	264
Triplett Electrical Instrument Co.	10

Ucinite Company	24
Ungar Electric Tools, Inc.	273
Union Carbide and Carbon Corp., Lundo Air Products Co.	254
United Manufacturing & Service Co.	30
United States Electronics Corporation	312
United States Rubber Stamp Co.	263
United Transformer Co.	Second Cover
Universal Winding Company	58

Varflex Sales Co., Inc.	215
Veeder-Root, Inc.	50
Victoreen Instrument Company	272

Wald Kohinoor, Inc.	49
Ward Leonard Electric Company	176
Waterman Products Co., Inc.	264
Webster Electric Company	162
Westinghouse Electric Corp.	38
White Dental Mfg. Company, S. S.	216, 257
Whitehead Stamping Company	262
Wilton Tool Mfg. Co.	253
Winchester Electronics, Inc.	249
Workshop Associates, Inc.	214

Zophar Mills, Inc.	234
--------------------	-----

PROFESSIONAL SERVICES 277

SEARCHLIGHT SECTION (Classified Advertising)

EMPLOYMENT	
Positions Vacant	280-285
Positions Wanted	285
Selling Opportunities Wanted	284, 285
Employment Service	280
EQUIPMENT	
(Used or Surplus New)	
For Sale	286-310
WANTED	
Equipment	308, 309

ADVERTISERS INDEX

Admiral Corporation	285
Airborne Instruments Laboratory, Inc.	285
Aircraft Armaments, Inc.	281
Aircraft Radio Industries, Inc.	309
Alvarado Supply Co.	307
American Electrical Sales Co.	308
American Electronics	306
Archy Electronics	306
Arrow Sales, Inc.	301

Barry Electronics Corp.	302, 309
Bell Aircraft Corp.	282
Bendix Aviation Corp.	283
Blan	298
Brooks Co., Inc., B. D.	304

C & H Sales Co.	302, 308
Chase Electronics Supply Co.	302
Columbia Electronics, Ltd.	303, 309
Communication Devices Co.	305
Communications Equipment Co.	290, 292
Compass Communications	300
Cornell Aeronautical Laboratory, Inc.	281
Cottone & Co., A.	300
Cue Fastener Corp.	300

East Coast Radio Co.	298
Eastern Air Devices	308
Electro Impulse Laboratory	301
Electronic Engineering Co. of Calif.	283
Electronic Specialty Supply Co.	302
Electroncraft, Inc.	293
Emerson Electric Mfg. Co.	282
Empire Electronics	300
Engineering Associates	309
E P C O	307

Freeland Products Co.	309
-----------------------	-----

General Electric Co.	281
General Motors Corp., AC Spark Plug Div.	284
Globe Trading Co.	300, 309
Goodyear Aircraft Corp.	280
Green, Gould	306

Instrument Associates	296
-----------------------	-----

J. S. H. Sales Co.	305
--------------------	-----

Kellett Aircraft Corp.	280
Kings County Machinery Exchange	306

Leetronic Research Laboratories	295
Liberty Electronics, Inc.	297
Long Island Radio Co.	302

Maki, George J.	307
Marino Radio Co.	299
Maritime International Co.	306, 308
Maritime Switchboard	298
Maxson Corp., The W. L.	284
Mongull Co., Inc., Alexander	303
Monmouth Radio Laboratories	309

Norman Radio Distributors, Inc.	306
Northrop Aircraft, Inc.	282

Phillips Petroleum Co.	283
Photocon Sales	307
Powell, Harold H.	304
Precision Electrical Instrument Co.	300

Radio & Electronic Surplus	298
Radio Development & Sales Co.	300
Radio Ham Shack, Inc.	286, 287
Raythem Mfg. Co.	302
Reliance Merchandizing Co.	294
Ruoff, L. R.	307

Sandia Corp.	283
Sagal Co., Leo	298
Sanett, Bob	308
Servo-Tek Products Co., Inc.	288
Sharples Corp., The	284
Smith, E.	308

Tab	310
Tallen Co., Inc.	306
Taylor Tubes, Inc.	284
Taylor-Winfield Corp., The	280
Technical Radio Parts Co.	304
Telemarine Communications Co.	304
Tracerlab	284

Universal General Corp.	305
-------------------------	-----

Wells Sales, Inc.	289
Weighman, Herbert G.	284
Western Electric Co.	284
Westinghouse Electric Corp.	282
Weston Laboratories	304, 308
West Region Electronics	309
Wilgreen	304
World Wide Packing & Shipping	308

This Index is published as a convenience to the readers. Every care is taken to make it accurate, but ELECTRONICS assumes no responsibility for errors or omissions.

DAVEN

Electronic Voltmeter Type 170-A

Vastly Improved

with

3

important, new features



1. Input stages of the amplifier are shock mounted to reduce microphonics.

2. The amplifier is completely shielded to prevent hum pick-up.

3. The power supply is completely shielded to prevent hum radiation in adjacent equipment.

Write

for completely detailed catalog data.



THE **DAVEN** CO.

191 CENTRAL AVENUE
NEWARK 4, NEW JERSEY

The New Daven Electronic Voltmeter, Type 170-A

is a superior, portable instrument, ideal for general laboratory and production use. It is built with typical Daven precision to measure accurately A.C. sinusoidal voltages over a frequency range from 10 to 250,000 cycles and a voltage range from .001 to 100 volts.

- Large, easy-to-read, illuminated, meter scale on which all readings may be made.
- Accuracy $\pm 2\%$ over entire frequency range.
- Output jack and separate volume control for using Voltmeter as wide-range, high-gain amplifier.
- Construction permits readings independent of normal power line variations.
- Meter scale has both voltage and decibel ranges.



L. S. THEES
General Sales Manager



W. L. ROTHENBERGER
Manager,
Sales Operations

M. J. CARROLL
Manager,
Equipment Sales

R. H. SIEMENS
Manager, Receiving
Tube & Kinescope Sales

C. E. BURNETT
Manager,
Industrial Tube Sales

G. B. WILSON
Manager, Electronic
Components Sales

C. W. TAYLOR
Manager, Tube Parts
& Machinery Sales



H. AS. GWYNNE
Ass't to
General Sales Manager

D. R. OZSVATH
Ass't to Manager,
Equipment Sales

R. L. KELLY
Manager, Field Appli-
cation Engineering

J. R. RIVERS
Manager,
Government Sales

G. H. MYERS
Manager,
Customer Relations

Headquarters Group

A nation-wide sales and engineering service to solve your tube and component problems

Sales & Engineering Field Force

CENTRAL



L. D. KIMMEL
Field Sales

W. HIEATT
Field Sales

D. R. YODER
Field Sales

EASTERN



J. W. KIRSCHNER
Field Sales

M. E. MARKELL
Field Sales

W. L. HOPKINS
Field Sales

J. F. COOPER
Field Sales

J. T. WILSON
Application
Engineering

T. B. PERKINS
Application
Engineering



T. R. HAYS
Field Sales

H. HAFKER
Application
Engineering

W. POND
Application
Engineering

W. H. WARREN
Application
Engineering

N. F. MACKENZIE
Application
Engineering

G. D. HANCHETT
Application
Engineering

G. W. DUCKWORTH
Application
Engineering

C. P. VOGEL
Application
Engineering

J. H. HALGREN
Application
Engineering

WESTERN



C. R. KLINGER
Field Sales

B. WALLEY
Application
Engineering

W. ROBINSON
Application
Engineering

At your service — when and where you want them — these seasoned experts devote their time exclusively to the problems of equipment manufacturers and government agencies.

In addition, the service of three completely equipped application engineering laboratories, in Harrison, N. J., Lancaster, Pa., and Chicago, Ill., are at the disposal of all RCA tube and component customers. Through these laboratory facilities, equipment manufacturers can avail themselves of RCA's extensive engineering skills and tube and component experience.

RCA maintains conveniently located district offices in Harrison, Chicago, and Los Angeles. To put RCA's sales and engineering organization to work for you, phone the nearest office* . . . or write RCA, Commercial Engineering, Section 42GR, Harrison, New Jersey.

* (EAST) Harrison 6-8000, 415 S. 5th St., Harrison, N. J. (MIDWEST) Whitehall 4-2900, 589 E. Illinois St., Chicago, Ill. (WEST) Trinity 5641, 420 S. San Pedro St., Los Angeles, Calif.

Special Field Sales & Engineering Force



J. H. MOSHER
Field Sales

R. F. DUNN
Application
Engineering

M. COPAN
Field Sales

J. WACHTEL
Application
Engineering



L. T. WEAGLE
Tube Parts &
Machinery Sales

R. E. NELSON
Field Sales, Gov't

W. D. LEAHY
Field Sales, Gov't

M. SPIVACK
Field Sales, Gov't



RADIO CORPORATION of AMERICA
ELECTRON TUBES
HARRISON, N. J.